

18V, 2A/4A Step-Down Silent Switcher 3 with Ultralow Noise Reference

FEATURES

- ▶ **Silent Switcher®3 Architecture**
 - ▶ **Ultralow RMS Noise (10Hz to 100kHz): 4 μ VRMS**
 - ▶ **Ultralow Spot Noise: 4nV/ $\sqrt{\text{Hz}}$ at 10kHz**
 - ▶ **Ultralow EMI Emissions on Any PCB**
 - ▶ **Internal Bypass Capacitors Reduce Radiated EMI**
- ▶ **High Efficiency at High Frequency**
- ▶ **Ultrafast Transient Response: 1 μ s**
- ▶ **Fast Minimum Switch On-Time: 12ns**
- ▶ **Input Voltage Range: 2.7V to 18V**
- ▶ **Output Voltage Range: 0V to (PVIN - 0.5V)**
- ▶ **2A/4A Maximum Continuous Output Current**
- ▶ **Precision Reference: $\pm 0.8\%$ Over Temperature with Remote Sense**
- ▶ PolyPhase® Operation: Up to 12 Phases
- ▶ Forced Continuous Mode Capability
- ▶ Adjustable and Synchronizable: 300kHz to 6MHz
- ▶ Programmable Power Good
- ▶ Small 20-Lead 4mm x 3mm LQFN Package

APPLICATIONS

- ▶ RF Power Supplies: PLLs, VCOs, Mixers, LNAs, PAs
- ▶ High Speed/High Precision ADCs/DACs
- ▶ Low Noise Instrumentation

TYPICAL APPLICATION

Figure 1. LT8624S Simplified Application Diagram

GENERAL DESCRIPTION

The **LT®8622S/LT®8624S** synchronous step-down regulator features third-generation Silent Switcher technology, which is uniquely designed to combine an ultralow noise reference with Silent Switcher architecture in order to achieve both high efficiency and excellent wideband noise performance.

The innovative ultralow-noise architecture provides exceptional low-frequency (0.1Hz to 100kHz) output noise performance in a switching regulator. The output voltage can be programmed with a single resistor, resulting in virtually constant output noise independent of output voltage. Silent Switcher architecture minimizes EMI emissions while delivering high efficiency at high switching frequencies.

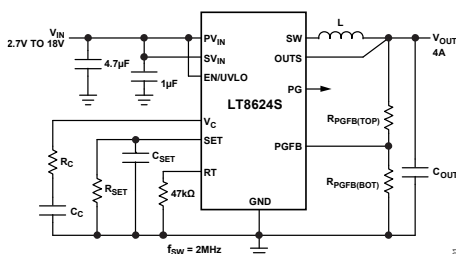
The LT8622S/LT8624S is ideal for high-current, noise-sensitive applications that benefit from the high efficiency of a synchronous switching regulator.

	CURRENT RATING	MAX TEMP	EXPOSED BACK	INTV_{CC} CAPACITOR
LT8622S	2A	125°C	No	Internal
LT8624S	4A	125°C	No	Internal
LT8625S	8A	125°C	No	Internal
LT8625SP	8A	150°C	Yes	External

Note: The LT8622S/LT8624S/LT8625S/LT8625SP are Pin-to-Pin Compatible.

All registered trademarks and trademarks are the property of their respective owners. Protected by U.S. patents, including 882334.

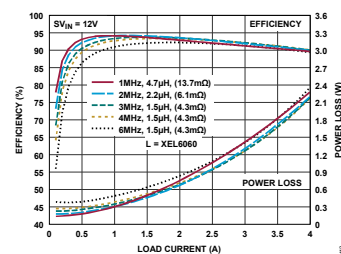
 Figure 2. 12V_{IN} to 5V_{OUT} Efficiency

REVISION HISTORY

Nature of Change	Page Number
6/2024 – Rev A: Initial release	—
8/2024 – Rev B: Updated General Description, Features, Specifications, Note 12, Pin Configuration and Function Descriptions, Figure 23, Low Frequency Output Noise, Synchronization, Frequency Compensation, and Figure 68	1, 5, 7, 9, 15, 22, 25, 33, 41
7/2025 – Rev C: Updated Absolute Maximum Ratings and Figure 68	5, 39

SPECIFICATIONS

Table 1. Electrical Characteristics

($T_J = -40^{\circ}\text{C}$ to $+125^{\circ}\text{C}$, unless otherwise noted. Typical values are at $T_A = +25^{\circ}\text{C}$. All voltages are referenced to GND, unless otherwise noted.)

PARAMETER	SYMBOL	CONDITIONS/COMMENTS	MIN	TYP	MAX	UNITS
Minimum PV_{IN}	PV_{IN}	$V_{SET} = 1\text{V}$		2.5	2.7	V
Minimum SV_{IN} ⁽⁸⁾	SV_{IN}	$V_{SET} = 1\text{V}$		2.5	2.7	V
SET Pin Current (I_{SET})	I_{SET}	$V_{SET} = V_{OUTS} = 1\text{V}$, $T_A = +25^{\circ}\text{C}$	99.7	100	100.3	μA
		$V_{SET} = V_{OUTS} = 1\text{V}$	99.2	100	100.8	
Fast Start-Up Set Pin Current	$I_{FAST_STARTUP}$	$SV_{IN} = 12\text{V}$, $V_{SET} = 1\text{V}$, $T_A = +25^{\circ}\text{C}$	2.2	2.7	3.2	mA
Start-Up Time Without Fast Start-Up ^(5, 11)	$t_{STARTUP}$	$V_{OUT} = 1\text{V}$, $C_{SET} = 1\mu\text{F}$, $SV_{IN} = 12\text{V}$, $V_{PGFB} = 0.5$		25		ms
		$V_{OUT} = 1\text{V}$, $C_{SET} = 4.7\mu\text{F}$, $SV_{IN} = 12\text{V}$, $V_{PGFB} = 0.5$		120		
Start-Up Time With Fast Start-Up ^(5, 11)	$t_{STARTUP}$	$V_{OUT} = 1\text{V}$, $C_{SET} = 1\mu\text{F}$, $SV_{IN} = 12\text{V}$, $R_{PGFB(TOP)} = 49.9\text{k}\Omega$, $R_{PGFB(BOT)} = 49.9\text{k}\Omega$		1		ms
		$V_{OUT} = 1\text{V}$, $C_{SET} = 4.7\mu\text{F}$, $SV_{IN} = 12\text{V}$, $R_{PGFB(TOP)} = 49.9\text{k}\Omega$, $R_{PGFB(BOT)} = 49.9\text{k}\Omega$		2.5		
Output Noise Spectral Density (10kHz) ^(5, 6, 7)	$V_{O,NSD(10kHz)}$	$SV_{IN} = 12\text{V}$, $V_{OUT} = 3.3\text{V}$, $C_{OUT} = 100\mu\text{F} \times 2$, $L = 820\text{nH}$, $R_{SET} = 33.2\text{k}\Omega$, $C_{SET} = 4.7\mu\text{F}$, $f_{SW} = 6\text{MHz}$, $R_C = 2.7\text{k}\Omega$, $C_C = 1\text{nF}$		4		$\text{nV}/\sqrt{\text{Hz}}$
Output RMS Noise (10Hz-100kHz) ^(5, 6, 7)	$V_{O,RMS}$	$SV_{IN} = 12\text{V}$, $V_{OUT} = 3.3\text{V}$, $\text{BW} = 10\text{Hz}$ to 100kHz , $C_{OUT} = 100\mu\text{F} \times 2$, $L = 820\text{nH}$, $R_{SET} = 3.3\text{k}\Omega$, $C_{SET} = 4.7\mu\text{F}$, $f_{SW} = 6\text{MHz}$, $R_C = 2.7\text{k}\Omega$, $C_C = 1\text{nF}$		2.3		μV_{RMS}
SV_{IN} Quiescent Current	I_Q	$V_{EN/UVLO} = 2\text{V}$, Not Switching, $T_A = +25^{\circ}\text{C}$		2.8	3.3	mA
		$V_{EN/UVLO} = 0.2\text{V}$, Shutdown, $T_A = +25^{\circ}\text{C}$		50	105	μA
Oscillator Frequency	f_{SW}	$R_T = 392\text{k}\Omega$	270	300	330	kHz
		$R_T = 47\text{k}\Omega$	1.93	2	2.07	
		$R_T = 9.76\text{k}\Omega$	5.4	6	6.6	MHz
PGFB Upper Threshold	V_{PGH}	V_{PGFB} Rising	529	537.5	546	mV
PGFB Upper Threshold Hysteresis	V_{PGH_HYS}			10		mV
PGFB Lower Threshold (Start-Up only)	$V_{PGL_STARTUP}$	V_{PGFB} Rising	479	486.5	495	mV
PGFB Lower Threshold	V_{PGL}	V_{PGFB} Falling	455	462.5	470	mV
PGFB Lower Threshold Hysteresis	V_{PGL_HYS}			10		mV
PGFB Pin Current	I_{PGFB}	$SV_{IN} = 6\text{V}$, $V_{EN/UVLO} = 3\text{V}$, $V_{PGFB} = 0.5\text{V}$		25		nA

($T_J = -40^{\circ}\text{C}$ to $+125^{\circ}\text{C}$, unless otherwise noted. Typical values are at $T_A = +25^{\circ}\text{C}$. All voltages are referenced to GND, unless otherwise noted.)

PARAMETER	SYMBOL	CONDITIONS/COMMENTS	MIN	TYP	MAX	UNITS
PG Leakage	I_{PG_LKG}	$V_{PG} = 3.3\text{V}$, $T_A = +25^{\circ}\text{C}$	-40		40	nA
PG Pull-Down Resistance	R_{PG}	$V_{PG} = 0.5\text{V}$		380	1200	Ω
SYNC Threshold	V_{IL}	SYNC DC and Clock Low Level Voltage, $T_A = +25^{\circ}\text{C}$	0.7			V
	V_{IH}	SYNC DC and Clock High Level Voltage, $T_A = +25^{\circ}\text{C}$			1.5	
OUTS Pin Output Current	I_{OUTS}	$V_{OUTS} = 1\text{V}$, $T_A = +25^{\circ}\text{C}$	80	160	240	nA
Output Voltage Line Regulation ⁽¹⁰⁾	$\Delta_{VOUT(LINE)}$	$V_{SVIN} = 4\text{V}$ to 18V , $T_A = +25^{\circ}\text{C}$		0.001	0.01	%/V
Error Amp Offset ^(9, 10)	$V_{EA, OFFSET}$	$V_C = 1.2\text{V}$, $V_{SET} = 3\text{V}$, $SV_{IN} = 6\text{V}$, PNP-Based Input Pair	-2		2	mV
		$V_C = 1.2\text{V}$, $V_{SET} = 5\text{V}$, $SV_{IN} = 5.5\text{V}$, NPN-Based Input Pair	-2		2	
Error Amp Transconductance ⁽⁹⁾	$g_{m(EA)}$	$V_C = 1.2\text{V}$, $V_{SET} = 1\text{V}$, $SV_{IN} = 6\text{V}$, PNP-Based Input Pair, $T_A = +25^{\circ}\text{C}$	9.5	12	14.5	mS
		$V_C = 1.2\text{V}$, $V_{SET} = 5\text{V}$, $SV_{IN} = 5.5\text{V}$, NPN-Based Input Pair, $T_A = +25^{\circ}\text{C}$	7.8	10	12.2	
Error Amp Gain	A_V	$V_C = 1.2\text{V}$, $V_{SET} = 1\text{V}$, $SV_{IN} = 6\text{V}$		2800		V/V
V_C Source Current ⁽⁹⁾	I_{VC-SRC}	$V_C = 1.2\text{V}$, $V_{SET} = 1\text{V}$, $V_{OUTS} = 0\text{V}$, $SV_{IN} = 6\text{V}$, PNP-Based Input Pair		330		μA
		$V_C = 1.2\text{V}$, $V_{SET} = 5\text{V}$, $V_{OUTS} = 4.7\text{V}$, $SV_{IN} = 5.5\text{V}$, NPN-Based Input Pair		330		
V_C Sink Current ⁽⁹⁾	I_{VC-SNK}	$V_C = 1.2\text{V}$, $V_{SET} = 1\text{V}$, $V_{OUTS} = 2\text{V}$, $SV_{IN} = 6\text{V}$, PNP-Based Input Pair		330		μA
		$V_C = 1.2\text{V}$, $V_{SET} = 5\text{V}$, $V_{OUTS} = 5.3\text{V}$, $SV_{IN} = 5.5\text{V}$, NPN-Based Input Pair		330		
V_C Pin to Switch Current Gain	G_M	LT8622S		3.8		A/V
		LT8624S		6		
V_C Clamp Voltage	V_{C_CLAMP}			2.2		V
SV_{IN} Current Consumption	I_{SVIN}	$f_{SW} = 2\text{MHz}$, $SV_{IN} = 6\text{V}$		11		mA
Minimum On-Time	$t_{ON(MIN)}$	$I_{LOAD} = 2\text{A}$		12	17	ns
Minimum Off-Time	$t_{OFF(MIN)}$	LT8622S, $I_{LOAD} = 1\text{A}$, $T_A = +25^{\circ}\text{C}$		70	90	ns
		LT8624S, $I_{LOAD} = 2\text{A}$, $T_A = +25^{\circ}\text{C}$		70	90	
Top Power NMOS Current Limit	$I_{PEAK-LIMIT}$	LT8622S	4.3	5	5.5	A
		LT8624S	6.75	8	9	
Bottom Power NMOS Current Limit	$I_{VALLEY-LIMIT}$	LT8622S, $T_A = +25^{\circ}\text{C}$	2.3	3	3.7	A
		LT8624S, $T_A = +25^{\circ}\text{C}$	4.6	5.7	6.8	

($T_J = -40^{\circ}\text{C}$ to $+125^{\circ}\text{C}$, unless otherwise noted. Typical values are at $T_A = +25^{\circ}\text{C}$. All voltages are referenced to GND, unless otherwise noted.)

PARAMETER	SYMBOL	CONDITIONS/COMMENTS	MIN	TYP	MAX	UNITS
SW Leakage Current	$I_{\text{SW_LKG}}$	$PV_{\text{IN}} = 18\text{V}$, $V_{\text{SW}} = 0\text{V}$, 18V , $T_A = +25^{\circ}\text{C}$	-15		15	μA
Power MOSFET On-Resistance Main Switch (Top)	$R_{\text{DS-ONH}}$			70		$\text{m}\Omega$
Power MOSFET On-Resistance Synchronous Switch (Bottom)	$R_{\text{DS-ONL}}$			29		$\text{m}\Omega$
EN/UVLO Threshold	V_{ENR}	EN/UVLO Rising	1.24	1.29	1.34	V
EN/UVLO Hysteresis	$V_{\text{EN_HYS}}$			50		mV
EN/UVLO Input Current	I_{EN}	$V_{\text{EN/UVLO}} = 2\text{V}$, $T_A = +25^{\circ}\text{C}$	-40		40	nA
EN Delay Time (5, 12)	$t_{\text{EN_DELAY}}$	$SV_{\text{IN}} = 12\text{V}$, $C_{\text{VCC}} = 1\mu\text{F}$ (internal), $R_C = 500$, $C_C = 10\text{nF}$, $C_{\text{SET}} = 2.2\mu\text{F}$		90		μs
PHMODE Thresholds	V_{PHMODE}	Between 180° and 120° , $T_A = +25^{\circ}\text{C}$	0.7		1.5	V
		Between 120° and 90° , $T_A = +25^{\circ}\text{C}$	2.0		2.7	



Table 2. Absolute Maximum Ratings⁽¹⁾

PARAMETER	RATING
PV_{IN} , SV_{IN} , EN/UVLO, PG	-0.3V to 18V
SYNC, OUTS, SET, PGFB	-0.3V to 6V
PHMODE	-0.3V to 4V
Operating Junction Temperature (2)	-40°C to 125°C
Storage Temperature Range	-65°C to 150°C
Peak Package Body Temperature	260°C

¹ Stresses beyond those listed under Absolute Maximum Ratings may cause permanent damage to the device. Exposure to any Absolute Maximum Rating condition for extended periods may affect device reliability and lifetime.

² The LT8622SA/LT8624SA is specified over the -40°C to 125°C operating junction temperature range. High junction temperatures degrade operating lifetimes. The junction temperature (T_J , in $^{\circ}\text{C}$) is calculated from the ambient temperature (T_A in $^{\circ}\text{C}$) and power dissipation (PD, in Watts) according to the formula:

$$T_J = T_A + (\text{PD} \cdot \theta_{\text{JA}})$$

where θ_{JA} (in $^{\circ}\text{C}/\text{W}$) is the package thermal impedance.

³ Thermal Resistance (θ) values determined per JEDEC 51-7, 51-12. See the [Applications Information](#) section for information on improving the thermal resistance and for actual temperature measurements of a demo board in typical operating conditions.

-
- ⁴ This IC includes overtemperature protection that is intended to protect the device during overload conditions. Junction temperature exceeds 150°C temperature when overtemperature protection is active. Continuous operation above the specified maximum operating junction temperature reduces lifetime.
- ⁵ Not subject to production test.
- ⁶ OOTS ties directly to VOUT.
- ⁷ Adding a capacitor across the SET pin resistor decreases output voltage noise. Adding this capacitor bypasses the SET pin resistor's thermal noise as well as the reference current's noise. Use of a SET pin bypass capacitor also increases start-up time.
- ⁸ Minimum SVIN can increase with OOTS once OOTS is above a certain value, due to the current reference architecture. Refer to Typical Characteristics curves for how this parameter changes with OOTS.
- ⁹ The PNP-based input pair is active for the error amplifier as long as SVIN is at least 1V above VSET. As SVIN drops to less than 1V above VSET, the part gradually transitions to operating with the NPN-based input pair active.
- ¹⁰ The LT8622S/LT8624S is tested in a feedback loop that servos VC to a specified voltage and measures the resultant VOUTS.
- ¹¹ The start-up time is defined as the time it takes from the EN/UVLO pin rising above the EN/UVLO threshold to when VOUT has reached 90% of final value.
- ¹² EN Delay Time is the time from EN/UVLO high to first switching cycle.

PIN CONFIGURATION AND FUNCTION DESCRIPTIONS

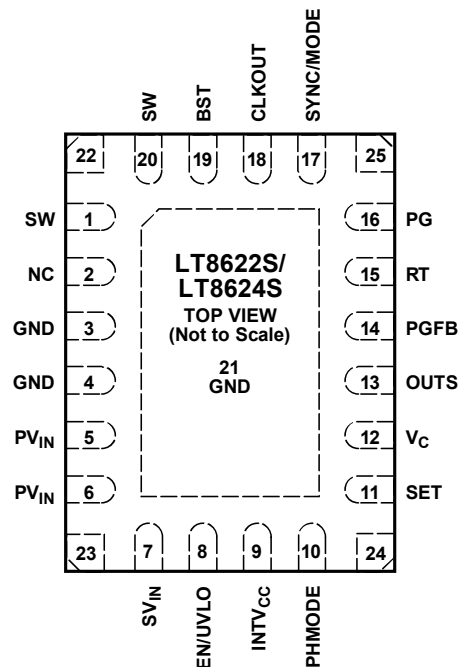

LQFN PACKAGE

20-LEAD (4mm x 3mm x 0.94mm)

JEDEC BOARD $\theta_{JA} = 46^{\circ}\text{C/W}$, $\theta_{JC(TOP)} = 40.3^{\circ}\text{C/W}$, $\theta_{JC(PAD)} = 12.8^{\circ}\text{C/W}$ (NOTE 3),DEMO BOARD: $\theta_{JA} = 30^{\circ}\text{C/W}$, $\Psi_{JT} = 2.0^{\circ}\text{C/W}$

EXPOSED PAD (PIN 21) IS GND, SHOULD BE SOLDERED TO PCB.

003

LQFN PACKAGE

20-Lead (4mm x 3mm x 0.94mm)

JEDEC BOARD $\theta_{JA} = 46^{\circ}\text{C/W}$, $\theta_{JC(TOP)} = 40.3^{\circ}\text{C/W}$, $\theta_{JC(PAD)} = 12.8^{\circ}\text{C/W}$ (3)DEMO BOARD $\theta_{JA} = 30^{\circ}\text{C/W}$, $\Psi_{JT} = 2.0^{\circ}\text{C/W}$

EXPOSED PAD (PIN 21) IS GND AND SHOULD BE SOLDERED TO PCB

Figure 3. Pin Configurations**Table 3. Pin Descriptions**

PIN	NAME	DESCRIPTION
1, 20	SW	The SW pins are the outputs of the internal power switches. Connect these pins together and connect them to the inductor. This node should be kept small on the PCB for good performance and low EMI.
2	NC	No Connect. This pin is not connected to internal circuitry and can be tied anywhere on the PCB, typically ground.
3, 4, 21	GND	Ground. Place the negative terminal of the input capacitor as close to the GND pins as possible. The exposed pads should be soldered to the PCB for good thermal performance. If necessary due to manufacturing limitations, the exposed pads may be left disconnected; however, thermal performance will be degraded.
5-6	PV _{IN}	Power V _{IN} . The PV _{IN} pins supply current to the LT8622S/LT8624S internal circuitry and to the internal top-side power switch. These pins must be connected together and be locally bypassed with a capacitor of 4.7 μF or more. Be sure to place the positive

		terminal of the input capacitor as close as possible to the PV _{IN} pins, and the negative capacitor terminal as close as possible to the GND pins.
7	SV _{IN}	Signal V _{IN} . This pin supplies current to the LT8622S/LT8624S internal circuitry and regulator. In order to provide sufficient headroom for the current reference, SV _{IN} must be at least 400mV higher than the desired regulation setpoint that is programmed via the SET pin. For example, for the desired regulation setpoint of 3.3V, SV _{IN} must be at least 3.3V + 400mV = 3.7V, or higher. See Typical Performance Characteristics curves. If connected to a different supply than PV _{IN} , place a 1μF local bypass capacitor on this pin.
8	EN/UVLO	A voltage at this pin greater than 1.29V enables switching, and a voltage less than 400mV is guaranteed to shut down the internal current bias and sub-regulators. The hysteric threshold voltage is 1.29V going up and 1.24V going down. Connect to PV _{IN} if the shutdown feature is not used. An external resistor divider from PV _{IN} is used to program a PV _{IN} threshold below which the LT8622S/LT8624S shuts down.
9	INTV _{CC}	Internal 3.4V Regulator Bypass Pin. The internal power drivers and control circuits are powered by this voltage. Do not load the INTV _{CC} pin with external circuitry. INTV _{CC} current is supplied by SV _{IN} . This pin should be floated.
10	PHMODE	The PHMODE pin sets the phase shift of the clock signal of the CLKOUT pin. Connect PHMODE to ground for a 180° phase shift, float for a 120° phase shift, connect high to INTV _{CC} (~3.4V) or an external supply >3V for a 90° phase shift. See Block Diagram for internal pull-up and pull-down resistances.
11	SET	This pin is the non-inverting input of the error amplifier and the regulation setpoint for the LT8622S/LT8624S. SET sources a precision 100μA current that flows through an external resistor connected between the SET and GND. The LT8622S/LT8624S's output voltage is determined by $V_{SET} = I_{SET} \cdot R_{SET}$ when used in the default unity gain configuration. SET pin voltage range is from zero to 6V. See the Output Voltages Above 6V section for applications with output voltages above 6V. Increasing the capacitor from SET to GND improves noise at the expense of increased start-up time. For optimum load regulation, Kelvin connect the ground side of the SET pin resistor directly to the load.
12	V _C	The V _C pin is the output of the internal error amplifier. The voltage on this pin controls the peak switch current. Connect an RC network from this pin to ground to compensate the control loop.
13	OUTS	Output Sense. This pin is the inverting input to the error amplifier. For optimal transient performance and load regulation, Kelvin connect OUTS directly to the output capacitor and the load.
14	PGFB	Power Good Feedback. The PG pin pulls low if PGFB increases above 537.5mV or decreases below 462.5mV. Connecting an external resistor divider between V _{OUT} , PGFB, and GND sets the programmable power good threshold with the following transfer function: $0.5V (\pm 7.5\%) \cdot (1 + R_{PGFB(TOP)}/R_{PGFB(BOT)})$. As discussed in the Applications Information section, PGFB also activates the fast start-up circuitry. The PGFB pin must be connected to 0.5V if power good and fast start-up functionalities are not needed.
15	RT	A resistor is connected between the RT and ground to set the switching frequency.

16	PG	The PG pin is the open-drain output of an internal comparator. PG remains low until the PGFB pin is within $\pm 7.5\%$ of 0.5V, and there are no fault conditions. PG is also pulled low when EN/UVLO is below 1.29V, $INTV_{CC}$ has fallen too low, SV_{IN} is too low, or during thermal shutdown. PG is valid when SV_{IN} is above 2.7V.
17	SYNC/MODE	For the LT8622S/LT8624S, this pin programs three different operating modes: 1) Pulse-skipping mode. Connect this pin to GND for pulse-skipping mode for improved efficiency at light loads. 2) Forced continuous mode (FCM). This mode offers fast transient response and full frequency operation over a wide load range. Connect this pin high to $INTV_{CC}$ (~3.4V) or an external supply >1.5V for FCM. The part also operates in this mode by default if this pin is left floating. 3) Synchronization mode. Drive this pin with a clock source to synchronize to an external frequency. During synchronization, the part operates in forced continuous mode.
18	CLKOUT	Output Clock Signal for PolyPhase Operation. The CLKOUT pin provides a 50% duty-cycle square wave of the switching frequency. The phase of CLKOUT with respect to the LT8622S/LT8624S's internal clock is determined by the state of the PHMODE pin. CLKOUT's peak-to-peak amplitude is $INTV_{CC}$ to GND. Float this pin if the CLKOUT function is not used.
19	BST	This pin is used to provide a drive voltage higher than the input voltage to the topside power switch. This pin should be floated.
22–25	Corner Pins	These pins are for mechanical support only and can be connected anywhere on the PCB. It is convenient to tie pin 22 to SW and to tie pin 23 to PV_{IN} .

TYPICAL PERFORMANCE CHARACTERISTICS

$T_A = 25^\circ\text{C}$, unless otherwise noted.

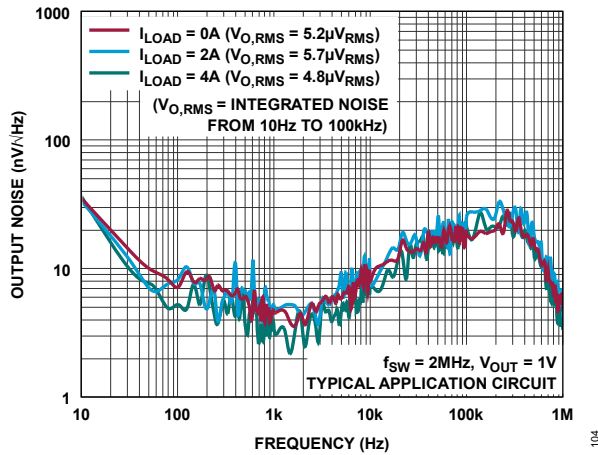

Figure 4. Noise Spectral Density vs Load

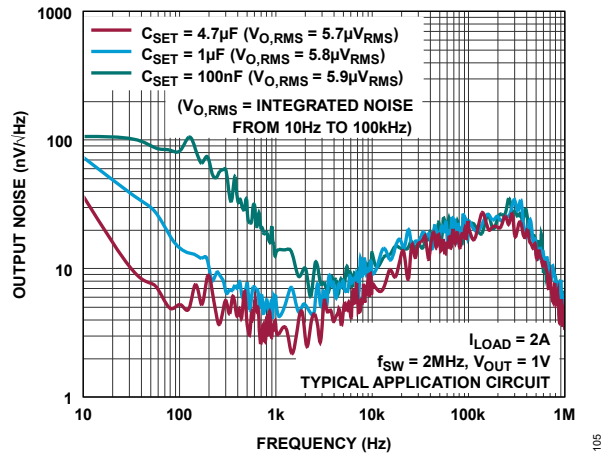

Figure 5. Noise Spectral Density vs C_{SET}

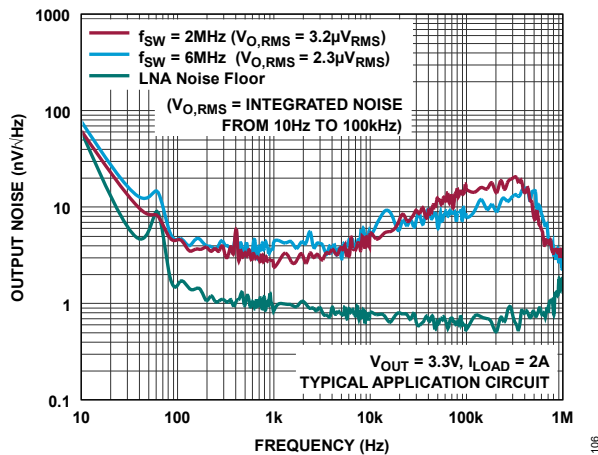

Figure 6. Noise Spectral Density vs f_{SW}

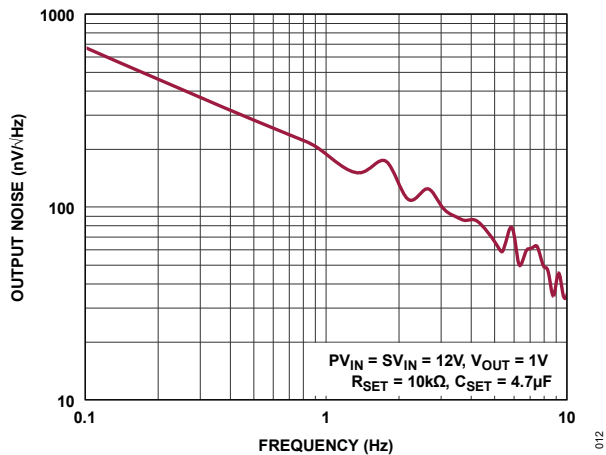

Figure 7. Noise Spectral Density (0.1Hz to 10Hz)

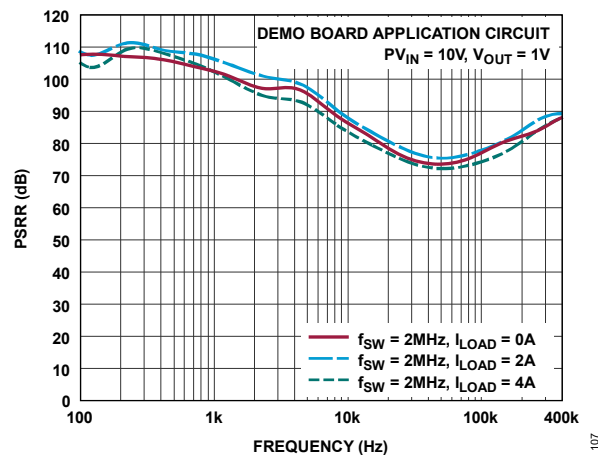

Figure 8. Power Supply Ripple Rejection

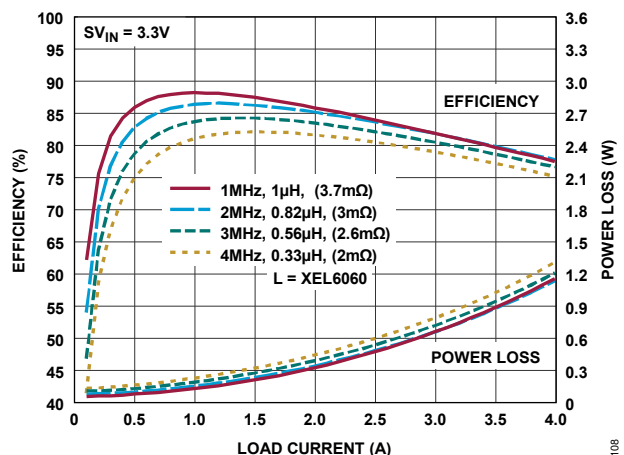

Figure 9. $12V_{IN}$ to $1V_{OUT}$ Efficiency

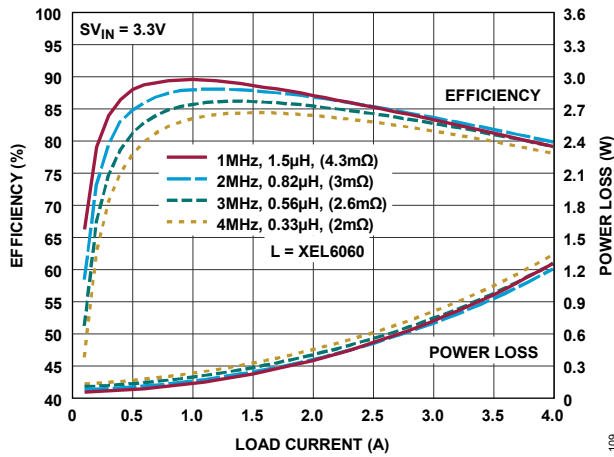

Figure 10. 12V_{IN} to 1.2V_{OUT} Efficiency

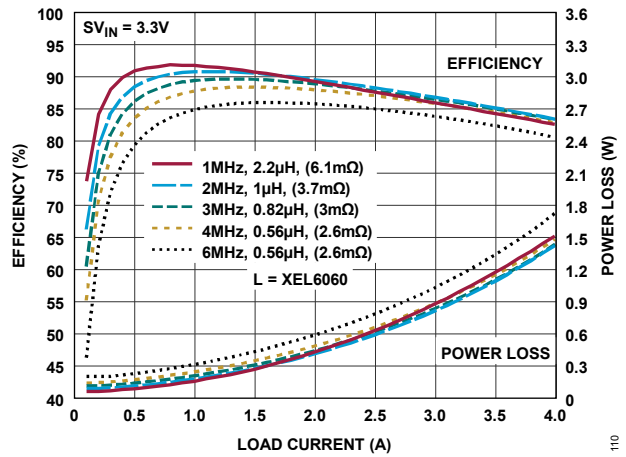

Figure 11. 12V_{IN} to 1.8V_{OUT} Efficiency

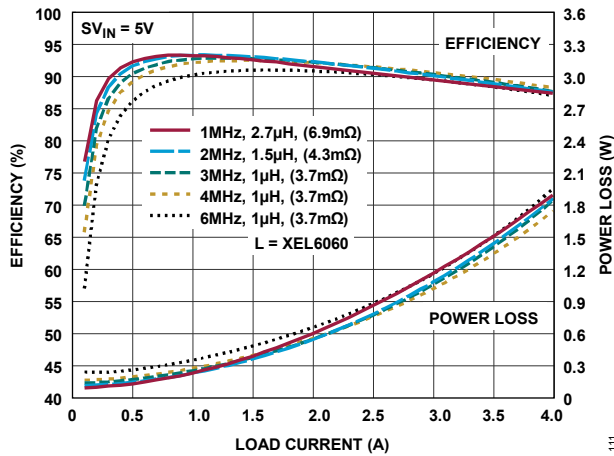

Figure 12. 12V_{IN} to 3.3V_{OUT} Efficiency

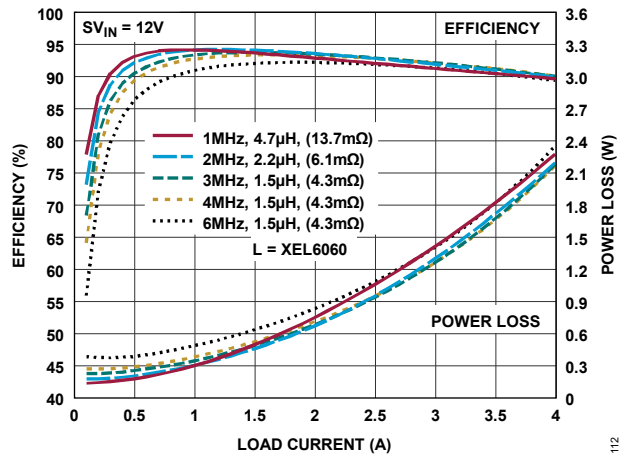

Figure 13. 12V_{IN} to 5V_{OUT} Efficiency

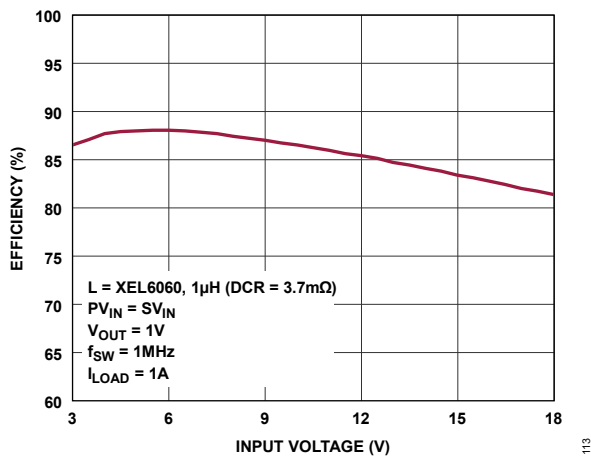

Figure 14. Efficiency vs V_{IN}

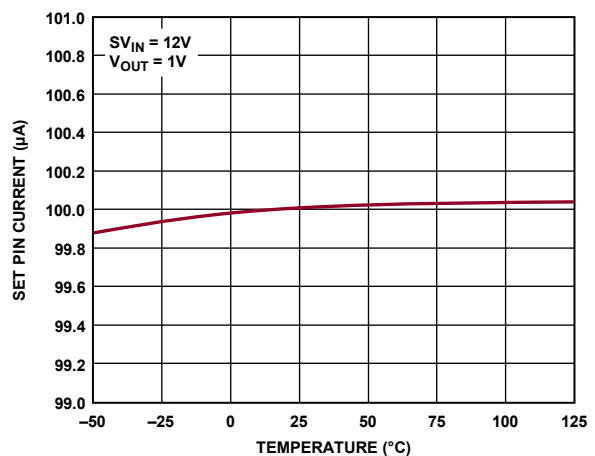

Figure 15. SET Pin Current

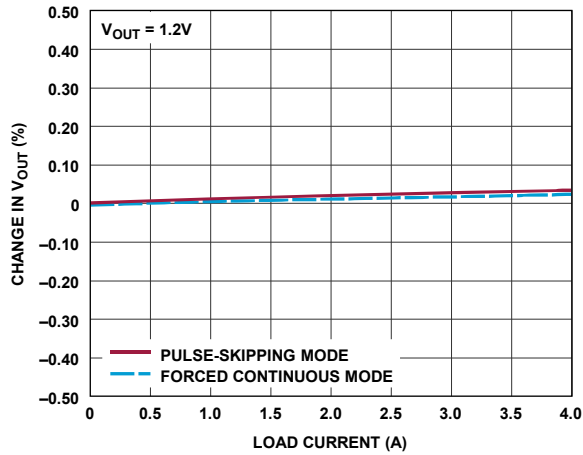

Figure 16. Load Regulation

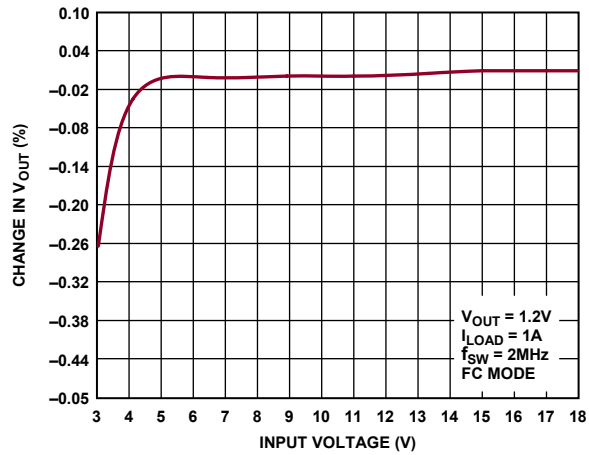

Figure 17. Line Regulation

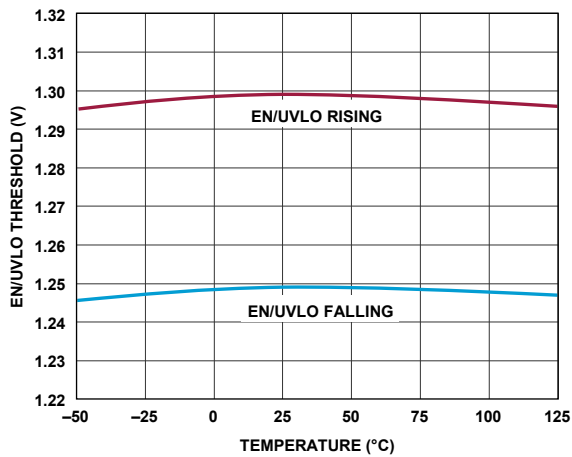

Figure 18. EN/UVLO Pin Thresholds

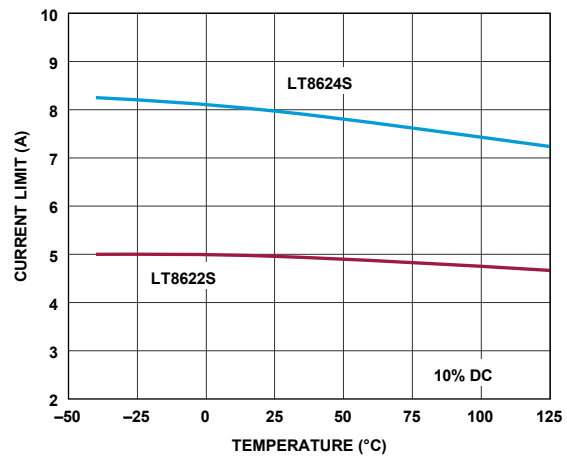

Figure 19. Top MOSFET Current Limit

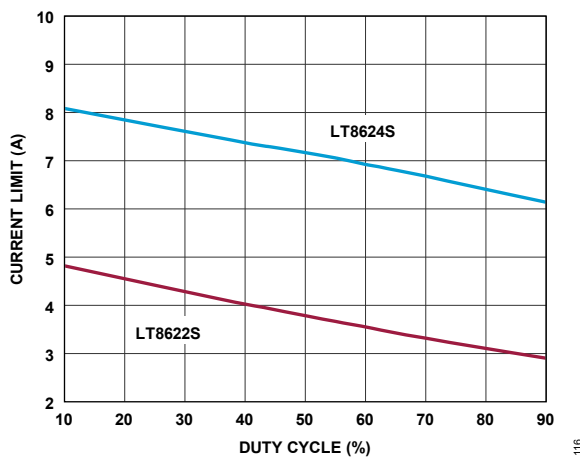

Figure 20. Top MOSFET Current Limit vs Duty Cycle

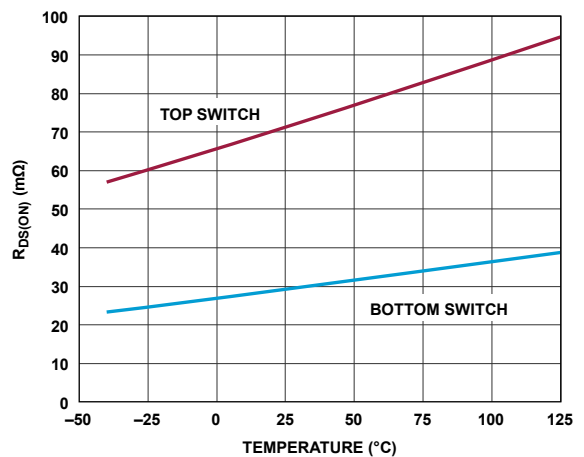

Figure 21. Switch $R_{DS(ON)}$ vs Temperature

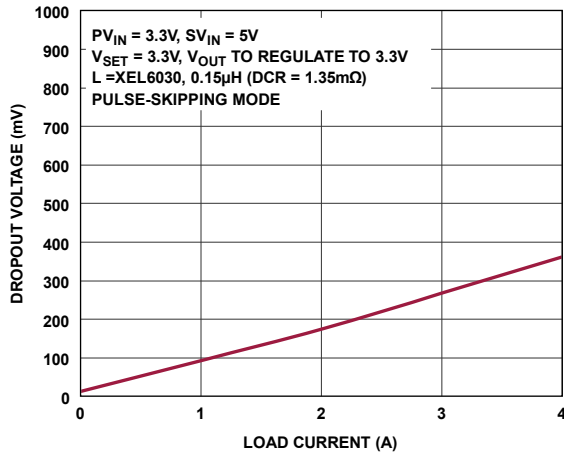

Figure 22. PV_{IN} Dropout Voltage

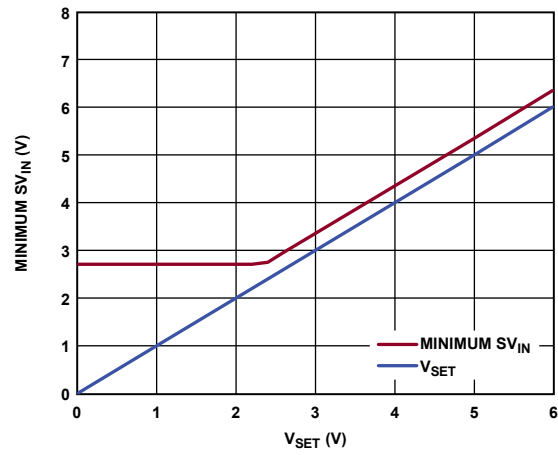

Figure 23. Minimum SV_{IN} as a Function of V_{SET}

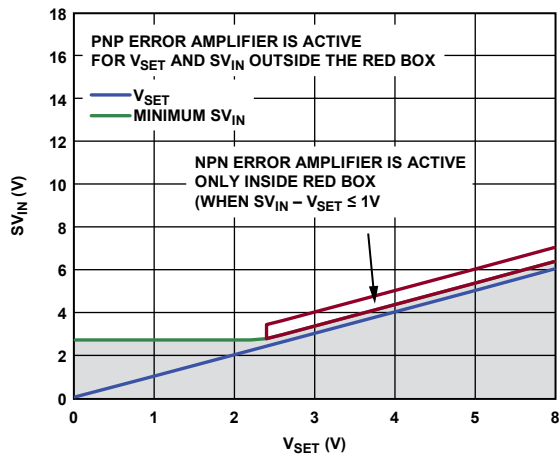

Figure 24. Minimum SV_{IN} as a Function of V_{SET}

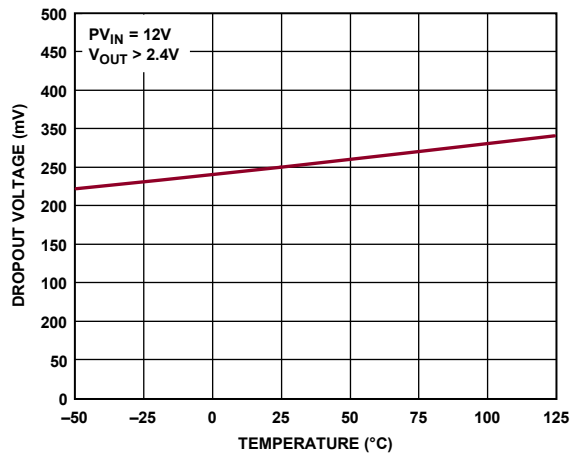

Figure 25. SV_{IN} Dropout Voltage

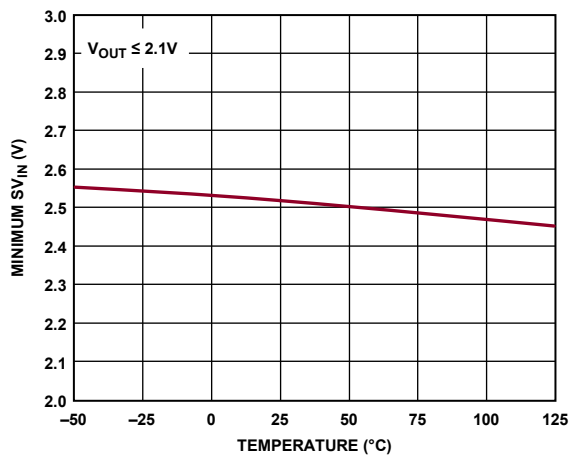

Figure 26. Minimum SV_{IN}

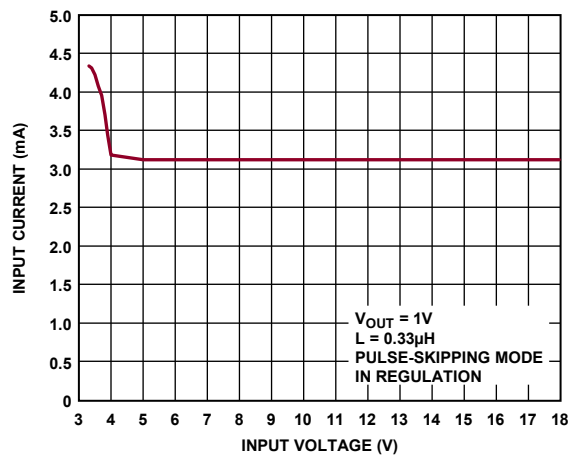

Figure 27. No-Load Supply Current

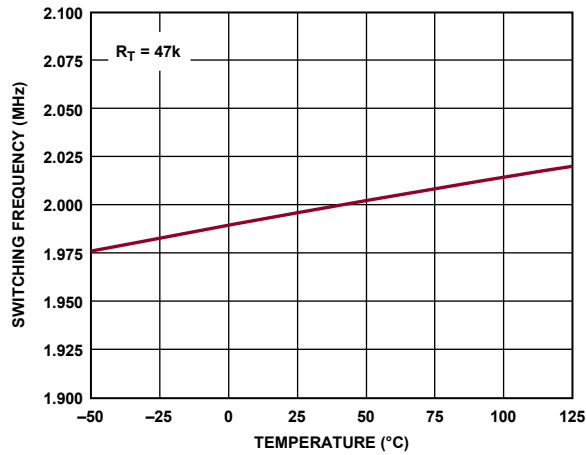

Figure 28. Switching Frequency

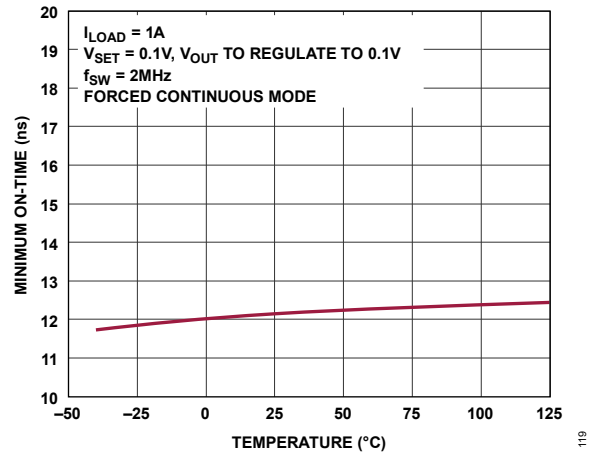

Figure 29. Minimum On-Time vs Temperature

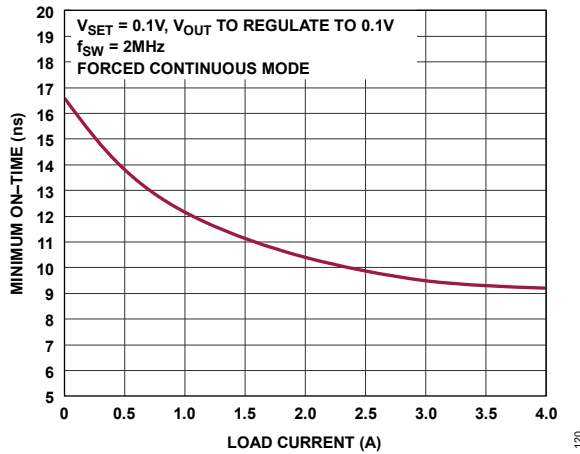

Figure 30. Minimum On-Time vs Load

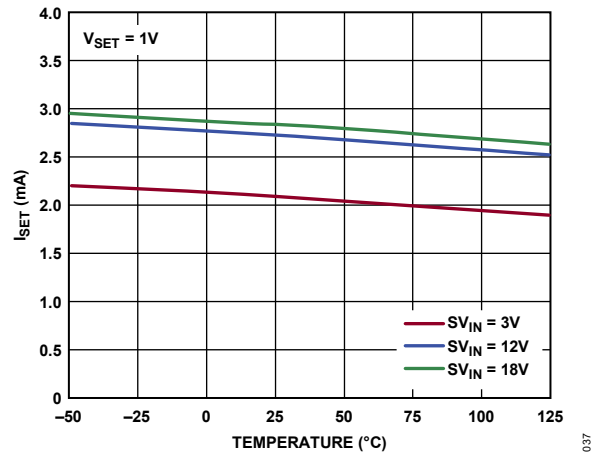

Figure 31. I_{SET} During Start-Up with Fast Start-Up Enabled

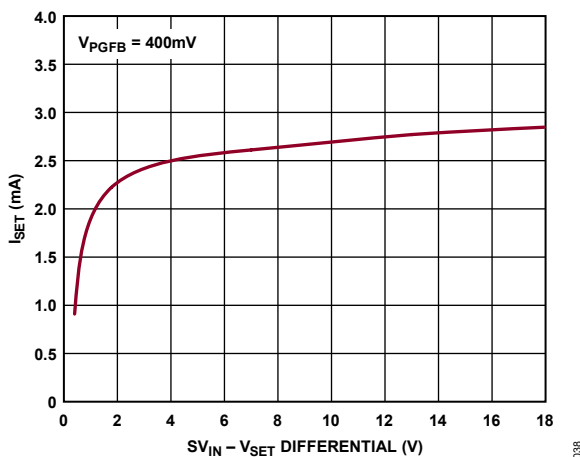

Figure 32. I_{SET} During Start-Up with Fast Start-Up Enabled

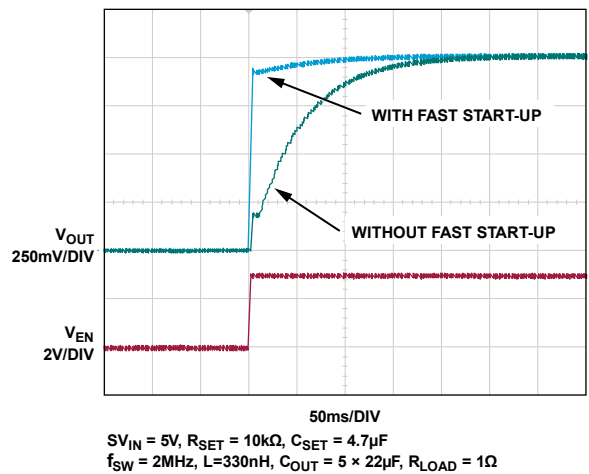
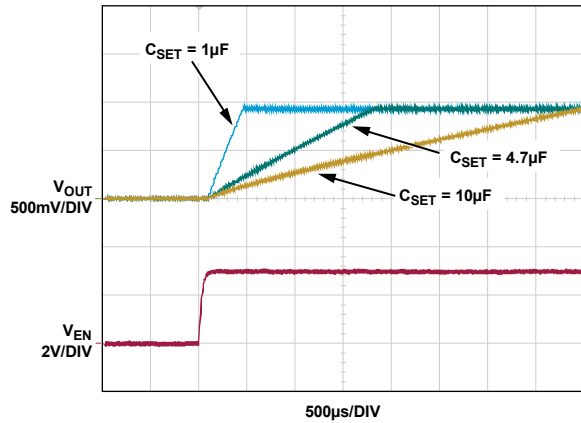

Figure 33. Start-Up Time with and without Fast Start-Up Circuitry for Large CSET



$S_{VIN} = 5V$, $R_{SET} = 10k\Omega$, with Fast Start-Up
 $f_{SW} = 2MHz$, $L = 330nH$, $C_{OUT} = 5 \times 22\mu F$, $R_{LOAD} = 1\Omega$

Figure 34. Soft-Start Waveforms

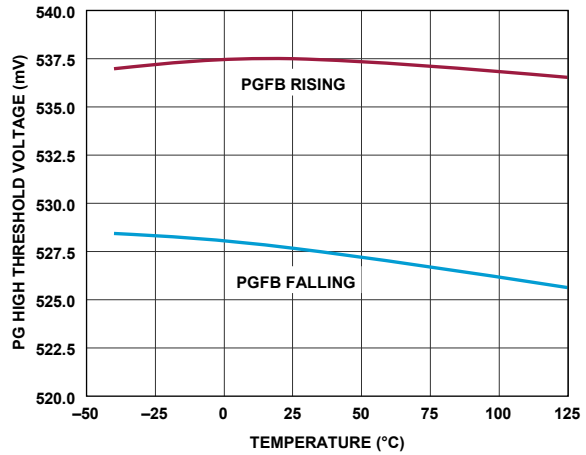

Figure 35. Power Good High Thresholds

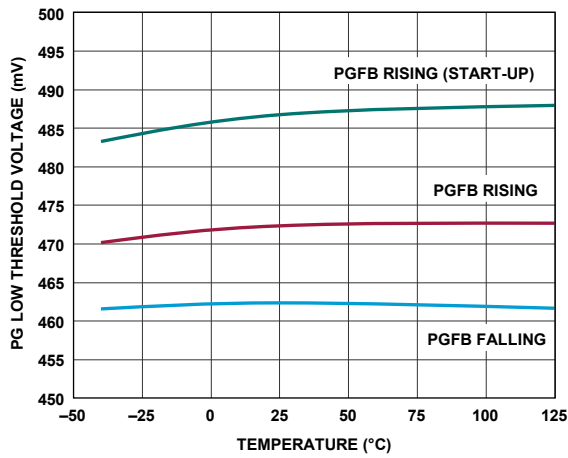

Figure 36. Power Good Low Thresholds

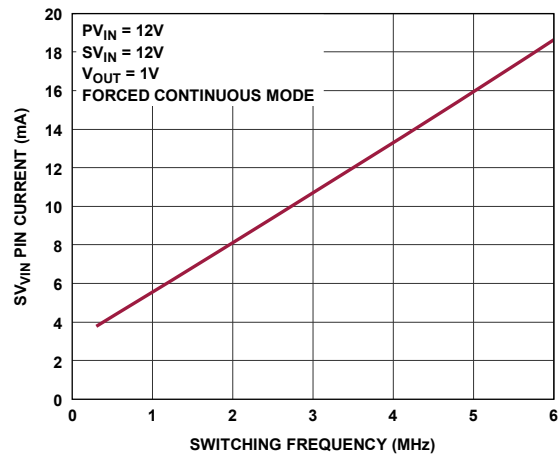

Figure 37. S_{VIN} Pin Current vs Frequency

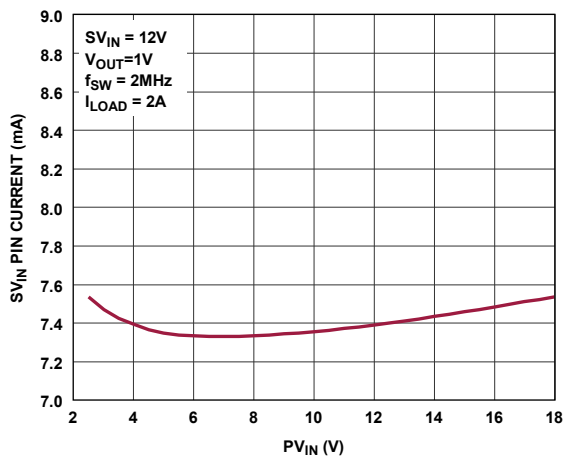

Figure 38. S_{VIN} Pin Current vs P_{VIN}

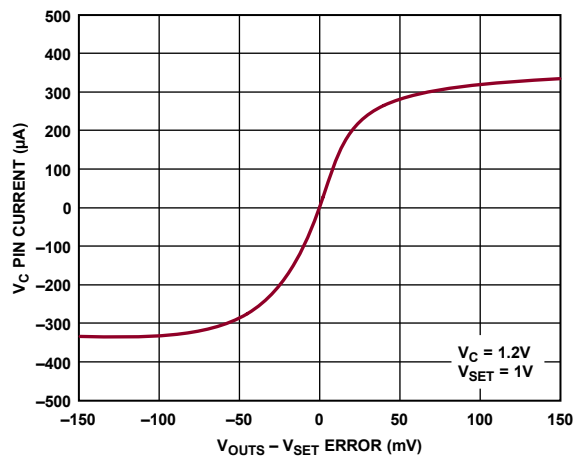

Figure 39. Error Amp Output Current

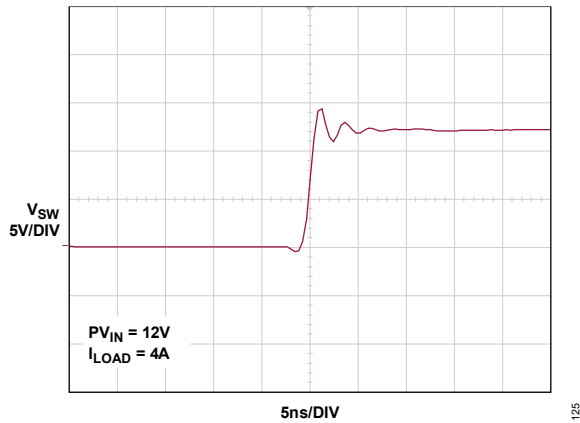

Figure 40. Switch Rising Edge

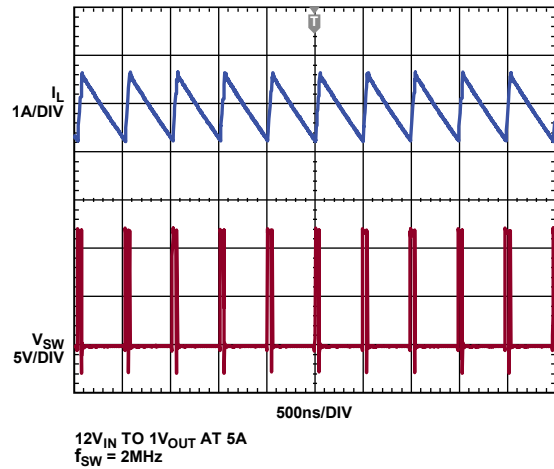

Figure 41. Switching Waveforms, Full Frequency Continuous Operation

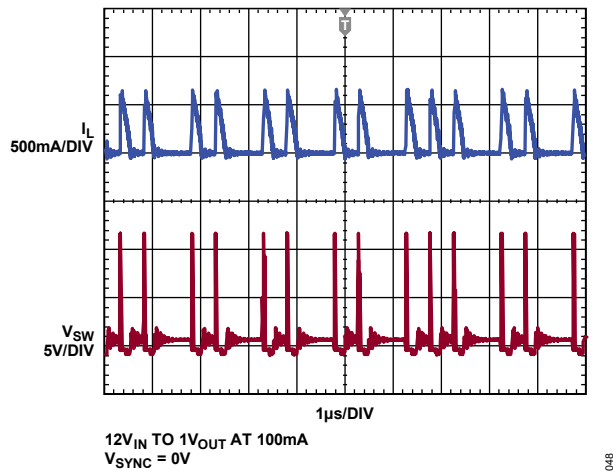

Figure 42. Switching Waveforms, Pulse-Skipping Operation

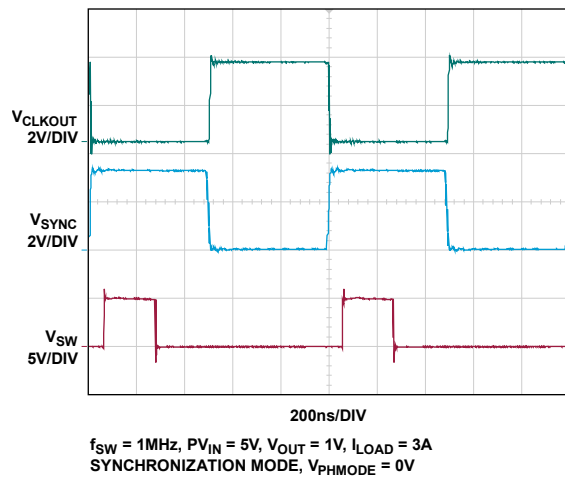

Figure 43. CLKOUT Waveforms

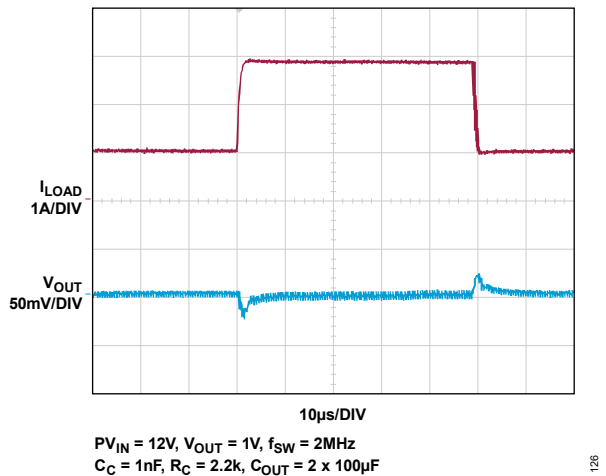

Figure 44. Transient Response: Load Current Stepped from 1A to 3A

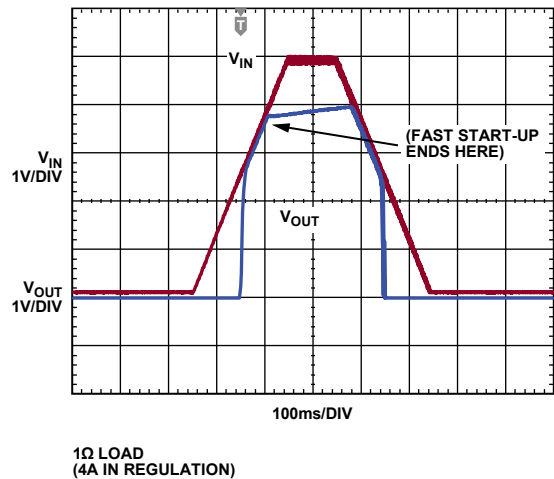
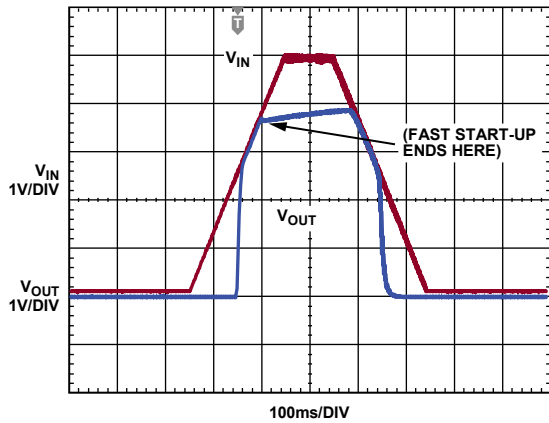

Figure 45. Start-Up Dropout Performance



20Ω LOAD
(200mA IN REGULATION)

Figure 46. Start-Up Dropout Performance

053

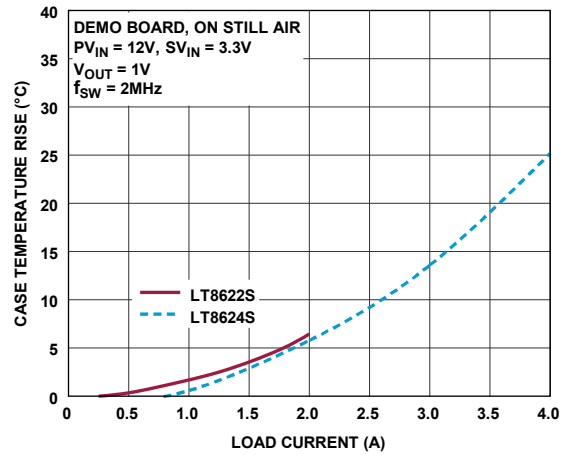
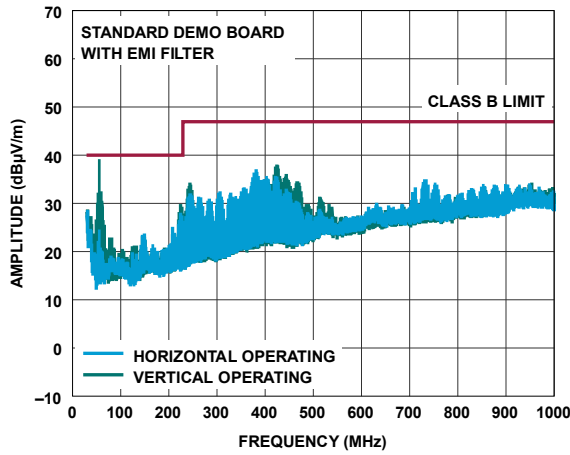

Figure 47. LT8622S/LT8624S Case Temperature Rise

131



12V INPUT TO 1V OUTPUT AT 2A, $f_{SW} = 2MHz$

Figure 48. LT8622S Radiated EMI Performance (CISPR32 Radiated Emission Test with Class B Limits)

128

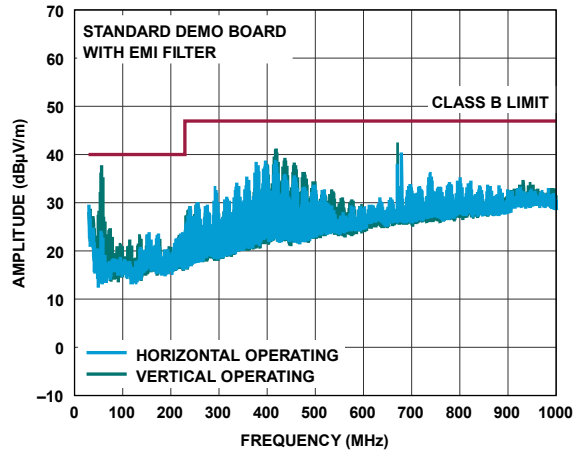

12V INPUT TO 1V OUTPUT AT 4A, $f_{SW} = 2MHz$

Figure 49. LT8624S Radiated EMI Performance (CISPR32 Radiated Emission Test with Class B Limits)

128

BLOCK DIAGRAM

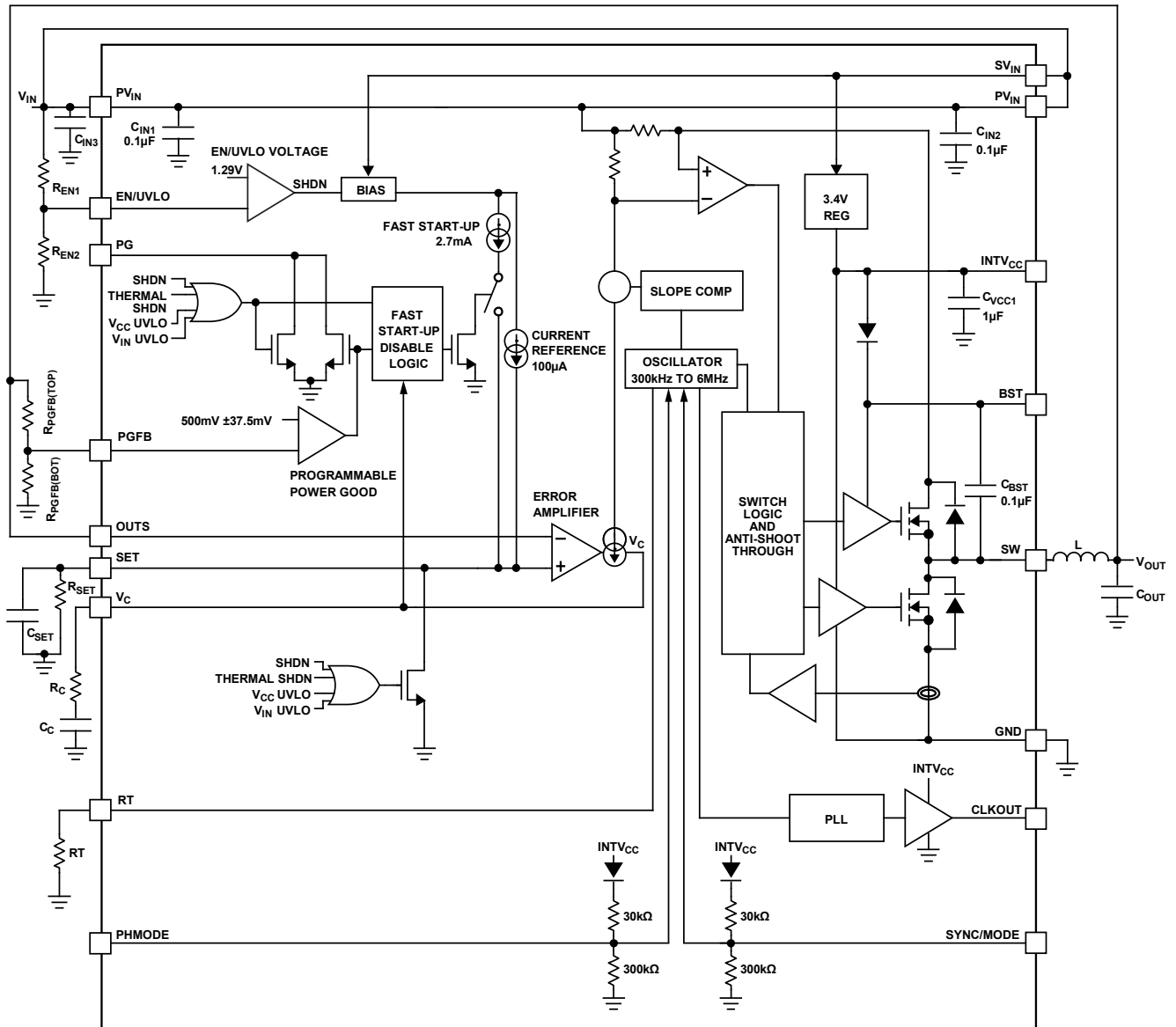

Figure 50. Block Diagram

THEORY OF OPERATION

The LT8622S/LT8624S is a constant-frequency, current-mode, monolithic step-down regulator, operating using a current reference-based architecture to allow the employment of unity gain in order to minimize output noise across all output voltages. An oscillator, with the frequency set using a resistor on the RT pin, turns on the internal top power switch at the beginning of each clock cycle. The current in the inductor increases until the top switch current comparator trips and turns off the top power switch. The peak inductor current at which the top switch turns off is controlled by the voltage on the V_C pin. The error amplifier servos the V_C node by comparing the voltage on the OUTS pin to the reference voltage on the SET pin, which is set by the user with a resistor from the SET pin to the ground. When the load current increases, it causes a reduction in the OUTS voltage relative to the reference, leading the error amplifier to raise the V_C voltage until the average inductor current matches the new load current. When the top power switch turns off, the synchronous power switch turns on until the next clock cycle begins or the inductor current falls to zero (only in the pulse-skipping mode). If overload conditions result in more than $3A(LT8622S)/5.7A(LT8624S)$ flowing through the bottom switch, the next clock cycle is delayed until the switch current returns to a safe level.

The “S” in LT8622S/LT8624S refers to the second-generation Silent Switcher technology. This technology allows fast switching edges for high efficiency at high switching frequencies while simultaneously achieving good EMI performance. This includes the integration of ceramic capacitors into the package for PV_{IN} , $INTV_{CC}$, and BST (see [Block Diagram](#)). These capacitors keep all the fast AC current loops small, which improves EMI performance.

The LT8622S/LT8624S features third-generation Silent Switcher technology, which combines an ultralow-noise current reference with second-generation Silent Switcher technology. The output voltage can be programmed with a single resistor, providing unity-gain operation over the output range resulting in virtually constant ultralow output noise independent of the output voltage.

If the EN/UVLO pin is below 0.4V, the LT8622S/LT8624S is shut down and draws 50 μ A from the input. When the EN/UVLO pin rises above 1.29V, the switching regulator becomes active.

To improve efficiency at light loads, the LT8622S/LT8624S can operate in pulse-skipping mode in light load situations. The SYNC pin is connected to ground to use pulse-skipping operation and connected to $INTV_{CC}$ or to a voltage higher than 3V or floated to use forced continuous mode (FCM). If a clock is applied to the SYNC pin, the part synchronizes to an external clock frequency and operates in FCM.

The LT8622S/LT8624S can operate in forced continuous mode (FCM) for fast transient response and full frequency operation over a wide load range. When in FCM, the oscillator operates continuously, and positive SW transitions are aligned to the clock. Negative inductor current is allowed. In this mode, the LT8622S/LT8624S can sink current from the output and return this charge to the input, improving load-step transient response.

To improve efficiency across all loads, the SV_{IN} pin can be powered from an independent supply at a voltage lower than PV_{IN} .

The V_C pin allows the loop compensation of the switching regulator to be optimized based on the programmed switching frequency, allowing for a fast transient response. The V_C and CLKOUT pins enable multiple LT8622S/LT8624S regulators to run out-of-phase, reducing the amount of required input and output capacitors. The PHMODE pin selects the phasing of CLKOUT for different multiphase applications.

APPLICATIONS INFORMATION

Low Frequency Output Noise

The LT8622S/LT8624S offers many advantages with respect to noise performance in the low frequency range (<100kHz). Conventional step-down regulators have several sources of low frequency noise. The most critical noise sources for a conventional regulator are its reference, error amplifier, noise from the resistor divider network used for setting output voltage and the noise gain created by this resistor divider.

Unlike most step-down regulators, the LT8622S/LT8624S does not use a voltage reference; instead, it uses a 100 μ A current reference. One problem that conventional step-down regulators face is that the resistor divider setting the output voltage gains up the reference noise. In contrast, the current reference architecture employed by the LT8622S/LT8624S allows unity-gain operation to avoid gaining up noise from the reference to the output. Therefore, if a capacitor bypasses the SET pin resistor, then the output noise is independent of the programmed output voltage. The resultant output noise is typically 4nV/ $\sqrt{\text{Hz}}$ at 10kHz.

With the previously mentioned noise sources operating at such low noise levels, other noise sources become non-negligible contributors to the output noise. Choosing a compensation network that achieves good transient performance with good phase margin ensures optimal noise performance. The [Frequency Compensation](#) section provides guidelines on how to choose appropriate compensation.

See [Figure 51](#) for the noise spectral density from 10Hz to 100kHz and 0.1Hz to 10Hz of the LT8622S/LT8624S. See the [Typical Performance Characteristics](#) section for noise measurements of a Typical Application Circuit at various load currents and SET pin capacitances.

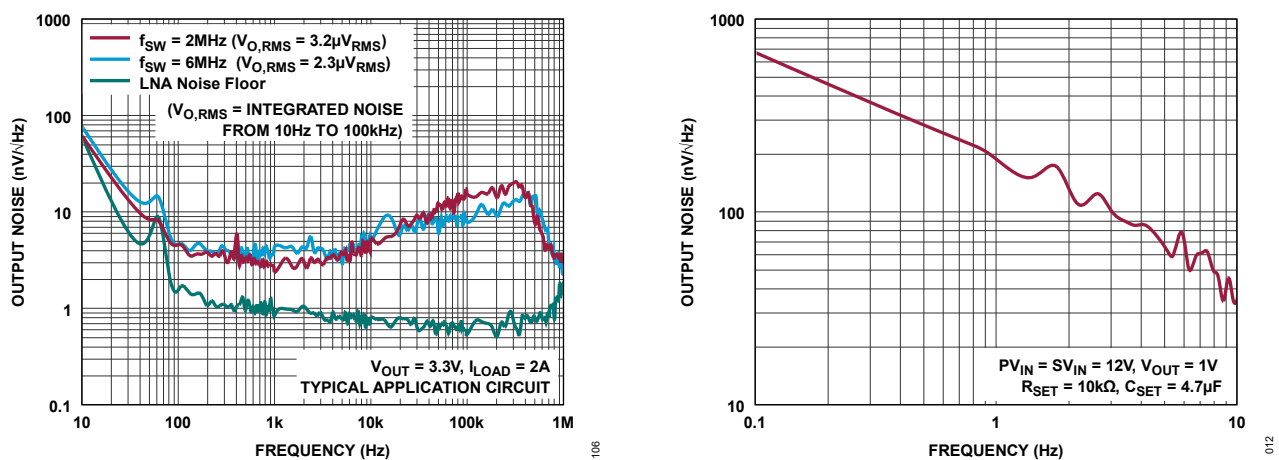

Figure 51. Noise Spectral Density

Filtering Switching Ripple and High Frequency Noise

The LT8622S/LT8624S is a switching regulator and will also have the typical artifacts of a switching regulator at the output, namely a ripple at the fundamental switching frequency as well as high-frequency spikes associated with the fast switching edges. While the output capacitor absorbs some of these spikes, the capacitor ESL limits its ability to do so at high frequencies. Additional filtering at the output in the form of feedthrough capacitors, ferrite beads, or an additional LC filter stage is recommended to eliminate these high-frequency spikes and significantly reduce switching ripple.

If additional switching ripple reduction is required while retaining fast transient response, ferrite beads, a PCB trace or feedthrough capacitors may be used. For feedthrough capacitors, ensure sufficient feedthrough capacitors are paralleled to carry the required load current. [Figure 52](#) shows an example where two 3A-rated feedthrough capacitors

are used for additional switching ripple suppression to deliver up to 6A at the output. In practice, this is limited to 4A for the LT8624S and 2A for the LT8622S.

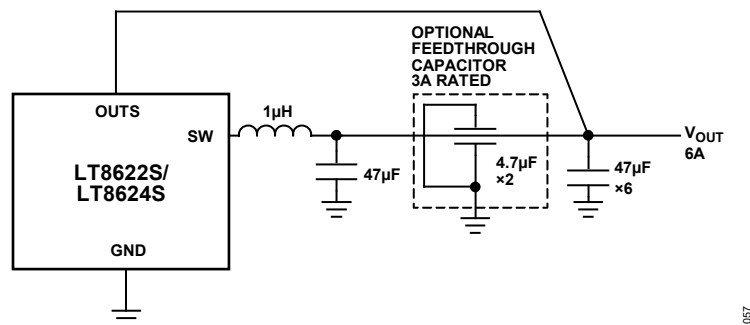

Figure 52. Additional Output Ripple Filtering Using Feedthrough Capacitors

If transient performance is not critical, other passive filter solutions can be realized using a physical inductor as a larger second L and additional output capacitance for the second C, as shown in [Figure 53](#).

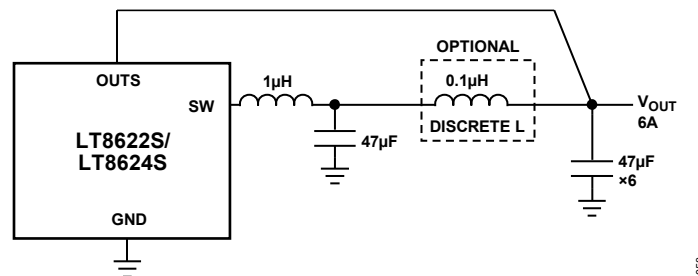

Figure 53. Additional Output Ripple Filtering Using a Second LC Filter

When designing an additional filter for further attenuation of the switching ripple, it is highly recommended to design with LTpowerCAD® to ensure that the design is stable with good phase margin and provides sufficient attenuation at the switching frequency of interest.

The Silent Switcher 3 architecture makes it possible to achieve excellent noise performance from low to high frequencies at the output of the LT8622S/LT8624S while utilizing only passive filtering.

PCB Layout Recommendations

The LT8622S/LT8624S is specifically designed to minimize low-frequency (10Hz–100kHz) noise and EMI emissions and maximize efficiency when switching at high frequencies. For optimal performance, the LT8622S/LT8624S can use multiple PV_{IN} bypass capacitors.

Two small capacitors are placed as close as possible to the LT8622S/LT8624S PV_{IN} pins, and the third capacitor with a larger value, 4.7µF or higher, should be placed near one of these two capacitors. See [Figure 54](#) for a recommended PCB layout.

For more details and PCB design files, refer to the Demo Board guide for the LT8622S/LT8624S. Note that large, switched currents flow in the LT8622S/LT8624S PV_{IN} and GND pins and the input capacitors. The loops formed by the input capacitors should be as small as possible by placing the capacitors adjacent to the PV_{IN} and GND pins. Capacitors with small case sizes, such as 0402 or 0603, are optimal due to their low parasitic inductance. Special care must be taken with the input capacitors to ensure they have a low-impedance return path to the IC ground. This is achieved by placing several grounds through the GND side of the input capacitors such that the ground plane is

utilized to full advantage. This should be an unbroken ground plane with a solid connection to the exposed pad of the IC, as shown in [Figure 54](#).

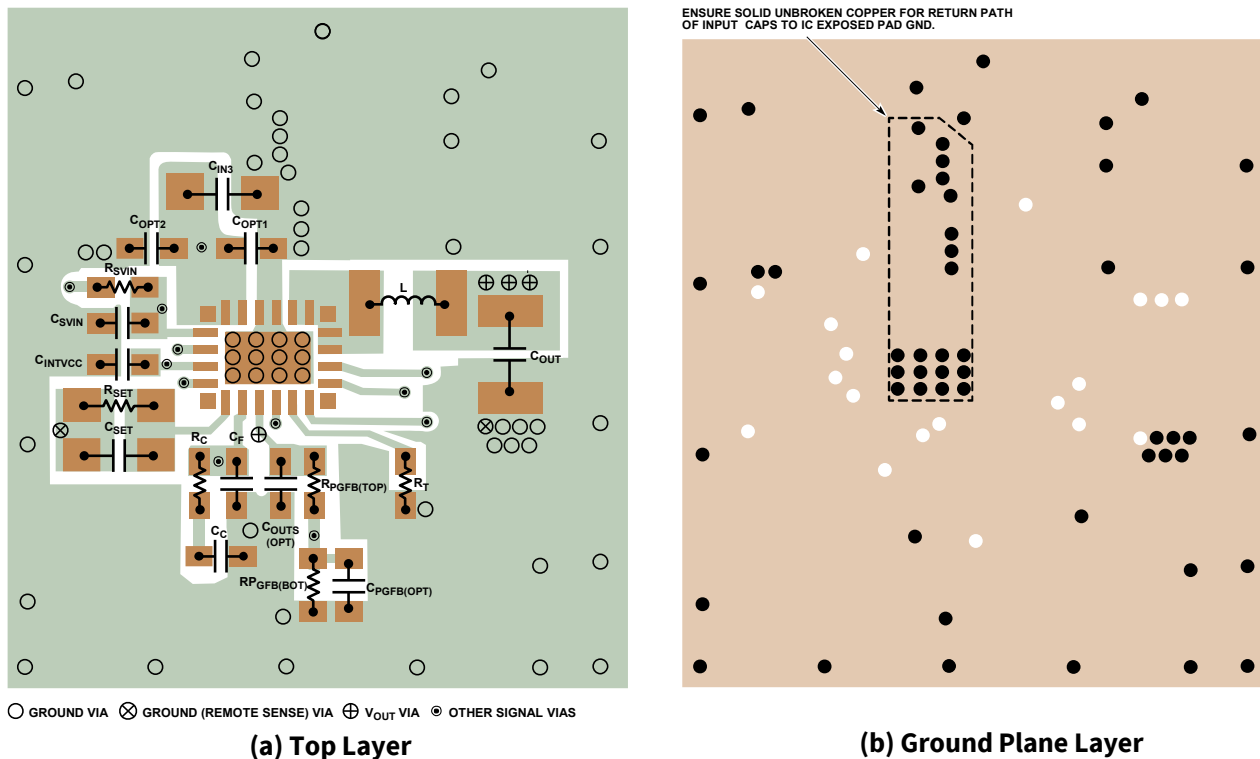

Figure 54. LT8622S/LT8624S Suggested Layout

The main inductor and output capacitors should be placed on the same side of the circuit board as the IC, and their connections should be made on that layer. The impedance of the output bulk capacitor's return path to IC ground should also be minimized through the generous use of ground vias. Care with ground layout prevents switching currents from the input capacitors coupling to the output through the ground, which can introduce unintentional perturbations onto the OUTS pin. A small capacitor may also be placed locally to decouple the OUTS pin if needed.

An additional LC filter, if used, can be placed on the other side of the circuit board for optimal EMI performance, though this is not required. Place a local unbroken ground plane under the application circuit on the layer closest to the surface layer. The SW and BOOST nodes should be as small as possible. Finally, keep the OUTS, PGFB, and RT nodes small so that the ground traces shield them from the SW and BOOST nodes. The OUTS, PGFB, and RT traces should not pass underneath the main inductor and should also be kept away from the inductor vias.

The exposed pad on the bottom of the package should be soldered to the PCB to reduce thermal resistance to ambient. To keep thermal resistance low, extend the ground plane from the GND as much as possible and add thermal vias to additional ground planes within the circuit board and on the bottom side.

The current reference architecture of the LT8622S/LT8624S allows remote sense of the negative terminals of the load in addition to the positive terminal; note the via on the ground side of the R_{SET} and C_{SET} going to the ground side of the C_{OUT} , which can be configured for remote sense of the negative terminal of a load placed further away. See the [Output Sensing and Stability](#) section for more information on implementing remote sense for the LT8622S/LT8624S.

Forced Continuous Mode

The LT8622S/LT8624S can operate in forced continuous mode (FCM) for fast transient response and full-frequency operation over a wide load range. When in FCM, the oscillator operates continuously, and positive SW transitions are aligned to the clock. Negative inductor current is allowed at light loads or under large transient conditions. In this mode, the LT8622S/LT8624S can sink current from the output and return this charge to the input, improving load-step transient response (see [Figure 55](#) for a comparison of pulse-skip mode and FCM with the LT8625S). At light loads, FCM operation is less efficient than pulse-skipping operation, but it may be desirable in applications where it is necessary to keep switching harmonics out of the signal band. FCM must be used if the output is required to sink current. To enable FCM, connect the SYNC/MODE pin to $INTV_{CC}$ or $> 1.5V$, or float the pin.

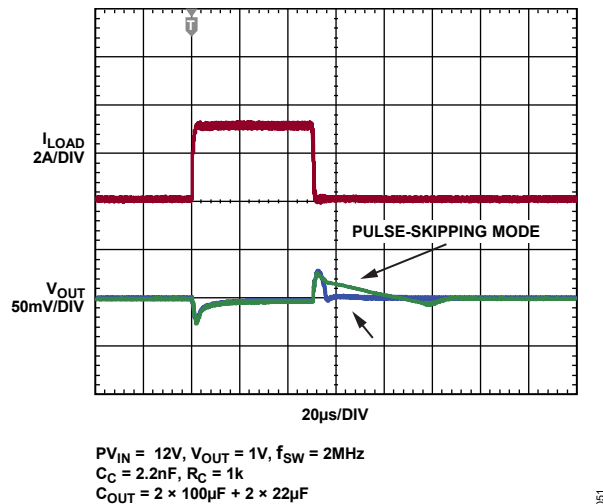

Figure 55. Load Step Transient Response with and without Forced Continuous Mode

FCM is disabled under PV_{IN} overvoltage conditions (PV_{IN} pin is held above 18V), if V_{OUT} is too high (PGFB pin is held greater than 537.5mV) and during start-up until the voltage on V_{OUT} has charged up to $\sim 97.5\%$ of its final value (as indicated when the PGFB pin rises to above 486.5mV). For the latter two conditions, it is assumed the PGFB pin is connected to the output voltage through an appropriate resistor divider. When FCM is disabled in these ways, negative inductor current is not allowed, and the LT8622S/LT8624S operates in pulse-skipping mode.

Pulse-Skipping Mode

When not operating in FCM, the LT8622S/LT8624S operates in pulse-skipping mode. In this mode, the oscillator operates continuously, and all switching cycles are aligned to the clock. The negative inductor current is not allowed in this mode; therefore, at light loads, the LT8622S/LT8624S may be operating in discontinuous mode. Additionally, in pulse-skipping mode, the LT8622S/LT8624S may also skip switching cycles at very light loads for improved efficiency or at very high duty cycles in order to achieve better dropout. To enable pulse-skipping mode, connect the SYNC/MODE pin to GND.

Synchronization

To synchronize the LT8622S/LT8624S oscillator to an external frequency, connect a square wave to the SYNC/MODE pin. The square wave amplitude should have valleys below 0.7V and peaks above 1.5V (up to 6V), with a minimum on-time and off-time of 50ns.

While synchronized to an external clock, the part runs in forced continuous mode to maintain regulation. The LT8622S/LT8624S may be synchronized over a 300kHz to 6MHz range. The RT resistor should be chosen to set the LT8622S/LT8624S switching frequency to below the lowest synchronization input by approximately 20%. For example, if the synchronization signal reaches 500kHz and higher, select the RT for 400kHz. The slope compensation is set by the RT value, while the minimum slope compensation required to avoid subharmonic oscillations is established by the inductor size, input voltage, and output voltage. Since the synchronization frequency does not change the inductor current waveform slopes, if the inductor is large enough to avoid subharmonic oscillations at the frequency set by RT, then the slope compensation is sufficient for all synchronization frequencies.

Setting the Switching Frequency

The LT8622S/LT8624S uses a constant-frequency PWM architecture that is programmed to switch from 300kHz to 6MHz by using a resistor connected from the RT pin to GND.

The R_T resistor required for the desired switching frequency is calculated with Equation 1.

$$R_T = \frac{114.8}{f_{sw}} - 10.4 \quad (1)$$

where R_T is in k Ω and f_{sw} is the desired switching frequency in MHz. [Table 4](#) shows the necessary R_T value for the desired switching frequency.

Table 4. SW Frequency vs R_T Value

f_{sw} (MHz)	R_T (k Ω)
0.3	392
0.4	287
0.5	226
0.6	187
0.7	154
0.8	137
0.9	118
1.0	105
1.2	86.6
1.4	71.5
1.6	61.9
1.8	53.6
2	47.0
2.5	35.7
3	28.7
3.5	23.2
4	18.0
6	9.76

Operating Frequency Selection and Trade-Offs

Selection of the operating frequency is a trade-off between efficiency, component size, and input voltage range. The advantage of high-frequency operation is that smaller inductor and capacitor values may be used. The

disadvantages are lower efficiency and a smaller input voltage range. The highest switching frequency ($f_{SW(MAX)}$) for a given application can be calculated using Equation 2.

$$f_{SW(MAX)} = \frac{V_{OUT} + V_{SW(BOT)}}{t_{ON(MIN)} \cdot (V_{IN} - V_{SW(TOP)} + V_{SW(BOT)})} \quad (2)$$

where V_{IN} is the typical input voltage, V_{OUT} is the output voltage, $V_{SW(TOP)}$ and $V_{SW(BOT)}$ are the internal switch drops ($\sim 0.28V$ and $\sim 0.12V$ respectively at maximum load) and $t_{ON(MIN)}$ is the minimum top switch on-time (see the *Electrical Characteristics* table). This equation shows that a slower switching frequency is necessary to accommodate a high V_{IN}/V_{OUT} ratio.

For transient operation, V_{IN} may go as high as the absolute maximum rating of 18V regardless of the R_T value; however, the LT8622S/LT8624S will reduce switching frequency as necessary to maintain control of the inductor current to assure safe operation.

In pulse-skipping mode, the LT8622S/LT8624S is capable of a maximum duty cycle of approximately 99%, and the V_{IN} -to- V_{OUT} dropout is limited by the $R_{DS(ON)}$ of the top switch, provided there is sufficient headroom ($\sim 0.4V$) between V_{IN} and SET for the current reference circuit to function correctly. In this mode, the LT8622S/LT8624S skips switch cycles, resulting in a lower switching frequency than programmed by R_T . The LT8622S/LT8624S switches as frequently as necessary to keep the boost capacitor refreshed, with a minimum switching frequency of approximately 80kHz. Note that higher switching frequencies increase the minimum input voltage below which cycles are dropped to achieve a higher duty cycle.

In FCM, the LT8622S/LT8624S does not skip cycles, and so the maximum duty cycle is limited by the minimum off time and chosen switching frequency. For applications that cannot allow deviation from the programmed switching frequency at low V_{IN}/V_{OUT} ratios and thus must operate in FCM, use Equation 3 to set the switching frequency.

$$V_{IN(MIN)} = \frac{V_{OUT} + V_{SW(BOT)}}{1 - f_{SW} \cdot t_{OFF(MIN)}} - V_{SW(BOT)} + V_{SW(TOP)} \quad (3)$$

where $V_{IN(MIN)}$ is the minimum input voltage without skipped cycles, V_{OUT} is the output voltage, $V_{SW(TOP)}$ and $V_{SW(BOT)}$ are the internal switch drops ($\sim 0.28V$ and $\sim 0.12V$, respectively, at maximum load), f_{SW} is the switching frequency (set by R_T), and $t_{OFF(MIN)}$ is the minimum switch off-time.

Inductor Selection and Maximum Output Current

The LT8622S/LT8624S is designed to minimize solution size by allowing the inductor to be chosen based on the output load requirements of the application. During overload or short circuit conditions, the LT8622S/LT8624S safely tolerates operation with a saturated inductor through the use of a high-speed peak-current mode architecture.

A good starting point for the inductor value is given by Equation 4.

$$L = \left(\frac{V_{OUT} + V_{SW(BOT)}}{f_{SW}} \right) \cdot 1.7 \quad (4)$$

where f_{SW} is the switching frequency in MHz, V_{OUT} is the output voltage, $V_{SW(BOT)}$ is the bottom switch drop ($\sim 0.12V$), and L is the inductor value in μH .

To avoid overheating and poor efficiency, an inductor must be chosen with an RMS current rating that is greater than the maximum expected output load of the application.

In addition, the saturation current rating (typically labeled I_{SAT}) of the inductor must be higher than the load current plus $\frac{1}{2}$ of the inductor ripple current. See Equation 5.

$$I_{L(\text{PEAK})} = I_{\text{LOAD}(\text{MAX})} + \frac{1}{2}\Delta I_L \quad (5)$$

where ΔI_L is the inductor ripple current as calculated in Equation 7 and $I_{\text{LOAD}(\text{MAX})}$ is the maximum output load for a given application.

As a quick example, an application requiring 3A output should use an inductor with an RMS rating of greater than 3A and an I_{SAT} of greater than 4A. During long-duration overload or short-circuit conditions, the inductor RMS rating requirement is greater to avoid overheating the inductor. To keep the efficiency high, the series resistance (DCR) should be less than 0.029Ω , and the core material should be intended for high-frequency applications.

The LT8622S/LT8624S limits the peak switch current in order to protect the switches and the system from overload faults.

The top switch current limit ($I_{\text{PEAK-LIMIT}}$) is 5A(LT8622S)/8A(LT8624S) at low duty cycles and decreases linearly to 3.1A(LT8622S)/6.4A(LT8624S) at duty cycle = 80%.

The inductor value must be sufficient to supply the desired maximum output current ($I_{\text{OUT}(\text{MAX})}$), which is a function of the top switch current limit ($I_{\text{PEAK-LIMIT}}$) and the ripple current (see Equation 6).

$$I_{\text{OUT}(\text{MAX})} = I_{\text{PEAK-LIMIT}} - \frac{\Delta I_L}{2} \quad (6)$$

The peak-to-peak ripple current in the inductor can be calculated using Equation 7.

$$\Delta I_L = \frac{V_{\text{OUT}}}{L \cdot f_{\text{SW}}} \cdot \left(1 - \frac{V_{\text{OUT}}}{V_{\text{IN}(\text{MAX})}}\right) \quad (7)$$

where f_{SW} is the switching frequency of the LT8622S/LT8624S, and L is the value of the inductor. Therefore, the maximum output current that the LT8622S/LT8624S delivers depends on the switch current limit, the inductor value, and the input and output voltages. The inductor value may have to be increased if the inductor ripple current does not allow sufficient maximum output current ($I_{\text{OUT}(\text{MAX})}$) given the switching frequency and maximum input voltage used in the desired application.

The optimum inductor for a given application may differ from the one indicated by this design guide. A larger-value inductor provides a higher maximum load current and reduces the output voltage ripple. For applications requiring smaller load currents, the value of the inductor may be lower, and the LT8622S/LT8624S may operate with a higher ripple current. This allows the use of a physically smaller inductor or one with a lower DCR, resulting in higher efficiency. Be aware that low inductance may result in discontinuous operation in pulse-skip mode, which further reduces the maximum load current.

For more information about maximum output current and discontinuous operation, see Analog Device's [Application Note 44](#).

For duty cycles greater than 50% ($V_{\text{OUT}}/V_{\text{IN}} > 0.5$), a minimum inductance is required to avoid sub-harmonic oscillation. See [Application Note 19](#). Equation 8 calculates that minimum inductance.

$$L_{\text{MIN}} = \frac{PV_{\text{IN}}(2 \cdot \text{DC} - 1)}{2.5 \cdot f_{\text{SW}}} \quad (8)$$

where DC is the duty cycle ratio ($V_{\text{OUT}}/V_{\text{IN}}$), and f_{SW} is the switching frequency.

Input Capacitors

The PV_{IN} of the LT8622S/LT8624S should be bypassed with at least three ceramic capacitors for best performance. Two small ceramic capacitors can be placed close to the part (C_{OPT1} , C_{OPT2}). These capacitors should be 0402 or 0603 in size.

Note that a larger input capacitance is required when a lower switching frequency is used. If the input power source has a high impedance or there is significant inductance due to long wires or cables, additional bulk capacitance may be necessary. This can be provided with a low-performance electrolytic capacitor.

A ceramic input capacitor combined with trace or cable inductance forms a high quality (under-damped) tank circuit. If the LT8622S/LT8624S is plugged into a live supply, the input voltage can ring to twice its nominal value, possibly exceeding the LT8622S/LT8624S's voltage rating. This situation is easily avoided (see Analog Device's [Application Note 88](#)). When SV_{IN} and PV_{IN} are powered from the same supply, a small RC filter (e.g., 10Ω and $1\mu F$) from the supply to SV_{IN} can be added for particularly noise sensitive applications. If SV_{IN} and PV_{IN} are powered from independent supplies, SV_{IN} should also be bypassed with a single small ceramic capacitor of at least $1\mu F$ placed as close to the pin as possible.

Output Capacitor and Output Ripple

The output capacitor has two essential functions. Along with the inductor, it filters the square wave generated by the LT8622S/LT8624S to produce the DC output. In this role, it determines the output ripple; thus, a low impedance at the switching frequency is important. The second function is to store energy in order to satisfy transient loads and stabilize LT8622S/LT8624S's control loop. Ceramic capacitors have very low equivalent series resistance (ESR) and provide the best ripple performance. For good starting values, see the [Typical Applications](#) section.

Use X5R or X7R types. This choice provides low output ripple and good transient response. Transient performance can be improved with a higher-value output capacitor. Increasing the output capacitance also decreases the output voltage ripple. A lower value of the output capacitor is used to save space and cost, but transient performance suffers, resulting in loop instability. See the [Typical Applications](#) in this data sheet for suggested capacitor values.

When choosing a capacitor, special attention should be given to the data sheet to calculate the effective capacitance under the relevant operating conditions of voltage bias and temperature. A physically larger capacitor or one with a higher voltage rating may be required.

The LT8622S/LT8624S typically operates at a switching frequency of 2MHz. [Table 5](#) shows some examples of output capacitors with ideal frequency characteristics when operating at switching frequencies around 2MHz. [Figure 56](#) shows the frequency characteristics of these capacitors; it can be seen that a combination of these capacitors minimizes the impedance at the switching frequency on the output and keeps the impedance low enough to suppress any higher-frequency harmonics near the switching frequency, thus achieving the lowest output ripple.

Table 5. Examples of Output Capacitors with Desirable Frequency Characteristics for 2MHz Operation

PART DESCRIPTION	MANUFACTURER/PART NUMBER
22 μF , X7R, 10V, 20% 1206	MURATA, GRM31CR71A226ME15K
10 μF , X7R, 25V, 10% 1206	MURATA, GRM31CR71E106KA12
4.7 μF , X7S, 16V, 10% 0603	MURATA, GRM188C71C475KE21

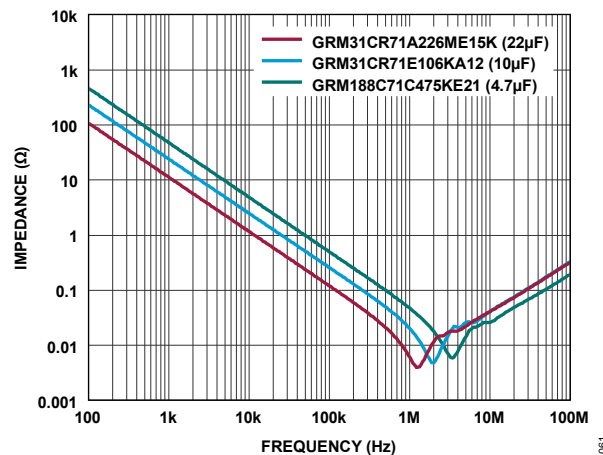

Figure 56. Frequency Characteristics of Example Output Capacitors for 2MHz Operation

Output Voltage

The LT8622S/LT8624S incorporates a precision $100\mu\text{A}$ current source flowing out of the SET pin, which also connects to the error amplifier's non-inverting input. Figure 57 illustrates that connecting a resistor from SET to GND generates a reference voltage for the error amplifier. This reference voltage is simply the product of the SET pin current and the SET pin resistor. The error amplifier's unity-gain configuration produces a low-impedance version of this voltage on its inverting input, the OUTS pin, which is externally connected to the output voltage of the circuit.

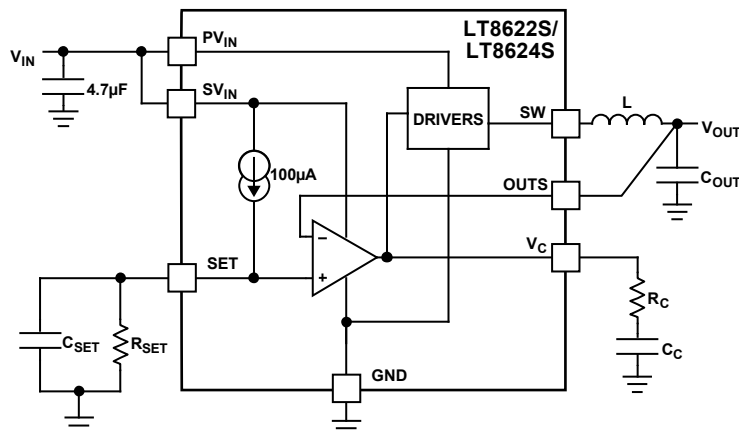

Figure 57. Adjustable Reference for Error Amplifier

The LT8622S/LT8624S's error amplifier and current reference allow for a wide output voltage range from 0V (using a 0Ω resistor) to 6V. A PNP-based input pair is active from V_{OUT} equals 0V up to V_{IN} minus 0.9V, and an NPN-based input pair is active for output voltages where $V_{\text{IN}} - V_{\text{OUT}} < 0.5\text{V}$ or less, with a smooth transition between the two input pairs in between these ranges. The PNP-based input pair is designed to offer the best overall performance as it is active in the vast majority of applications. See the *Electrical Characteristics* table for details on offset voltage and SET pin current and output noise. Table 6 lists many common output voltages and their corresponding 1% R_{SET} resistors. Where the exact resistor value required for the output voltage is not available, two resistors can be paralleled to achieve the desired value. For example, for a 0.8V output voltage, a resistor value of exactly $8\text{k}\Omega$ is desired. The closest value with a single 1% resistor is $8.06\text{k}\Omega$; with two resistors, $8.25\text{k}\Omega$ can be paralleled with $267\text{k}\Omega$ to achieve (almost) exactly $8\text{k}\Omega$. 0.1% resistors may be used in order to achieve higher accuracy.

Table 6. 1% Resistor for Common Output Voltages

V_{OUT} (V)	R_{SET} (k Ω)
0.8	8.06
1	10
1.8	18
2.5	24.9
3.3	33.2
5	49.9

The benefit of using a current reference compared with a voltage reference, as used in conventional regulators, is that the regulator always operates in a unity gain configuration, independent of the programmed output voltage. This allows the LT8622S/LT8624S to have loop gain, frequency response, and bandwidth independent of the output voltage. Moreover, since none of the error amp gain is needed to amplify the SET pin voltage to a higher output voltage, output load regulation is more tightly specified.

Since the zero T_C current source is highly accurate, the SET pin resistor can become the limiting factor in achieving high accuracy. Hence, it should be a precision resistor. Additionally, any leakage paths to or from the SET pin create errors in the output voltage. If necessary, use high-quality insulation (e.g., Teflon, Kel-F); moreover, cleaning of all insulating surfaces to remove fluxes and other residues may be required. High-humidity environments may require a surface coating at the SET pin to provide a moisture barrier.

Since the SET pin is a high-impedance node, unwanted signals may couple into the SET pin and cause erratic behavior. This is most noticeable when operating with a minimum output capacitor at heavy load currents. Bypassing the SET pin with a small capacitance to GND resolves this issue—100nF is sufficient. This is the minimum recommended capacitance. In general, a larger capacitance is typically preferred (see the [Set Pin \(Bypass\) Capacitance: Noise, Transient Response, and Soft-Start](#) section).

For applications requiring higher accuracy or an adjustable output voltage, the SET pin may be actively driven by an external voltage source capable of sinking 100 μ A. Connecting a precision voltage reference to the SET pin eliminates any errors present in the output voltage due to the reference current SET pin resistor tolerances.

Output Voltages Above 6V

The LT8622S/LT8624S can be configured for output voltages above 6V, even though the SET pin voltage is limited to a maximum of 6V, by using a traditional resistor divider from V_{OUT} to O_{UTS} as shown in [Figure 58](#). It is recommended to configure the SET pin voltage to be 5V, in which case the resistor values can be chosen according to Equation 14.

$$R1 = R2 \left(\frac{V_{OUT} - 5V}{5V + R2 \cdot I_{O_{UTS}}} \right) \quad (14)$$

The O_{UTS} pin current must be taken into consideration in this configuration as an output divider is used. The O_{UTS} pin current ($I_{O_{UTS}}$) when $V_{SET} > 2V$ is 10 μ A \pm 2.5 μ A including variation over process and temperature. When $V_{SET} \leq 2V$, the O_{UTS} pin current is 160nA \pm 80nA per the Electrical Characteristics table. The divider values R1 and R2 can be chosen such that this O_{UTS} pin current variation introduces <0.1% error in output voltage regulation.

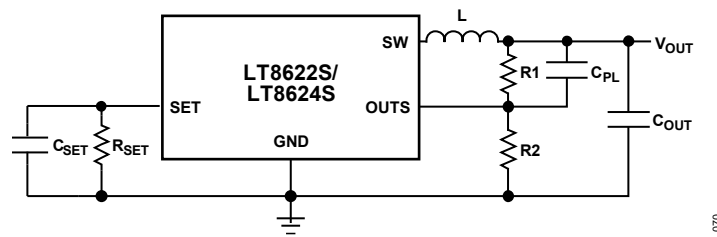

Figure 58. Configuring the LT8622S/LT8624S for Output Voltages above 6V

At output voltages above 6V, the low-frequency noise has some dependence on the output voltage; the divider gains up the noise. By configuring the SET voltage to be 5V, this dependency is minimized; for example, the noise gain from a 5V reference to $9V_{OUT}$ is ten times lower than the gain from a conventional 0.5V voltage reference to $9V_{OUT}$.

Output Voltages Below 0.5V

Due to the current reference architecture, the LT8622S/LT8624S can be configured for output voltages below 0.5V all the way down to 0V. It should be noted that for output voltages below 0.5V, the Power Good and Fast Start-Up functionalities will not be available, and these functionalities must be disabled correctly by tying PGFB to 0.5V. An example of a $0.2V_{OUT}$ application using the LT8624S can be found in [Typical Applications](#).

Output Sensing and Stability

The LT8622S/LT8624S's OUTS pin provides a Kelvin sense connection to the output. The SET pin resistor's GND side provides a Kelvin sense connection to the load's GND side.

The LT8622S/LT8624S internal error amplifier has a relatively high voltage gain of ~ 2800 . Therefore, it is very important to avoid adding extra impedance (ESR and ESL) to the feedback loop and to minimize the noise coupling onto the OUTS pin, as a combination of excessive parasitics and noise injection can cause instability in the system. To that end, minimize the effects of PCB trace and solder inductance by tying the OUTS pin directly to C_{OUT} and the GND side of C_{SET} directly to the GND side of C_{OUT} . If this is not possible, for example, due to a design requiring remote sensing, a small local OUTS capacitor of 150pF or less may be added for noise decoupling at the OUTS pin. Refer to the LT8622S/LT8624S demo board manual for more information on the recommended layout that meets these requirements.

The LT8622S/LT8624S is an externally compensated part, so even if the recommended layout is not followed (sometimes it is not possible due to application-specific limitations), it is possible to choose a more conservative compensation with a lower gain or bandwidth in order to retain stability during operation. However, this would be at the expense of a transient response. A superior layout allows a better tradeoff between transient response, phase margin, and output noise performance when selecting compensation values.

Frequency Compensation

Loop compensation determines the stability and transient performance and is provided by the components connected to the V_C pin. Generally, a capacitor (C_C) and a resistor (R_C) in series to ground are used. Designing the compensation network can be complicated, and the best values depend on the application. A practical approach is to start with one of the circuits in this data sheet that is similar to your application and tune the compensation network to optimize the performance. LTpowerCAD simulation can help in this process. Stability should then be checked across all operating conditions, including load current, input voltage, and temperature. The LT1375 data sheet contains a more thorough discussion of loop compensation and describes how to test the stability using a transient load.

Figure 59 shows an equivalent circuit for the LT8622S/LT8624S control loop. The error amplifier is a transconductance amplifier with transconductance $g_m = 12\text{mS}$, with finite output impedance. The power section, consisting of the modulator, power switches, and inductor, is modeled as a transconductance amplifier with transconductance $G_M = 3.8\text{S(LT8622S)}/6\text{S(LT8624S)}$ generating an output current proportional to the voltage at the V_C pin. Note that the output capacitor integrates this current and that the capacitor on the V_C pin (C_C) integrates the error amplifier output current, resulting in two poles in the loop. A zero is required and comes from a resistor R_C in series with C_C . This simple model works as long as the value of the inductor is not too high and the loop crossover frequency is much lower than the switching frequency. For more information about the compensation of switching mode power supplies, refer to [Application Note 149: Modeling and Loop Compensation Design of Switching Mode Power Supplies](#).

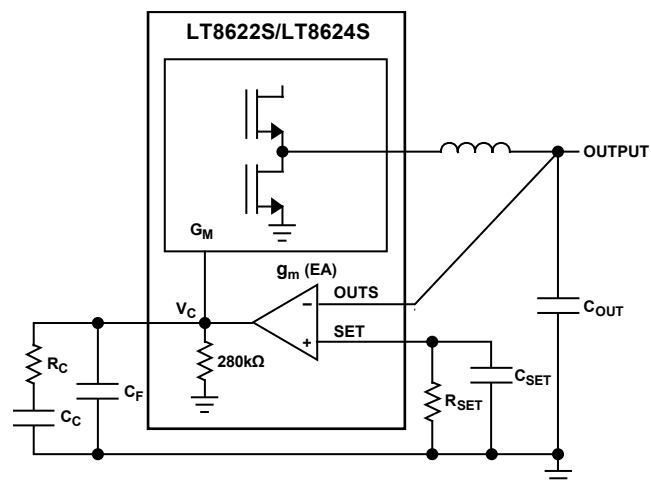

Figure 59. Model for Loop Response

Enable Pin

The LT8622S/LT8624S is in shutdown when the EN/UVLO pin is low and active when the pin is high. The rising threshold of the EN/UVLO comparator is 1.29V, with 50mV of hysteresis. The EN/UVLO pin can be connected to PV_{IN} if the shutdown feature is not used or tied to a logic level if shutdown control is required.

When the enable pin drops below 1.29V, the part enters a shutdown state where the part stops switching, but internal circuitry continues drawing current as the $INTV_{CC}$ regulator is still awake. Full shutdown is guaranteed when the enable pin drops below 400mV. In full shutdown the $INTV_{CC}$ regulator is disabled, and the part draws less than 100 μA .

Adding a resistor divider from PV_{IN} to EN/UVLO programs the LT8622S/LT8624S to regulate the output only when PV_{IN} is above the desired voltage (see the [Block Diagram](#)). This threshold, $PV_{IN(EN)}$, is typically used when the input supply is either current limited or has a relatively high source resistance. A switching regulator draws constant power from the source, so the source current increases as the source voltage drops. This looks like a negative resistance load to the source and causes the source to current limit or latch low under low source voltage conditions. The $PV_{IN(EN)}$ threshold prevents the regulator from operating at source voltages where the problems might occur. This threshold can be adjusted by setting the values of R_{EN1} and R_{EN2} such that they satisfy Equation 9.

$$PV_{IN(EN)} = \left(\frac{R_{EN1}}{R_{EN2}} + 1 \right) \cdot 1.29\text{V} \quad (9)$$

where the LT8622S/LT8624S remains off until PV_{IN} is above $PV_{IN(EN)}$. Due to the comparator's hysteresis, switching does not stop until the input falls slightly below $PV_{IN(EN)}$.

INTV_{CC} Regulator

An internal low dropout (LDO) regulator produces the 3.4V supply from SV_{IN} that powers the drivers and the internal bias circuitry. The INTV_{CC} supplies enough current for the LT8622S/LT8624S's circuitry. The voltage on INTV_{CC} varies between 2.6V and 3.4V when SV_{IN} is between 2.7V and 3.5V. If SV_{IN} is connected to a different supply than PV_{IN}, be sure to bypass SV_{IN} with a local ceramic capacitor. Do not connect an external load to the INTV_{CC} pin.

Set Pin (Bypass) Capacitance: Noise, Transient Response, and Soft-Start

In addition to reducing output noise, using a SET pin bypass capacitor reduces the sensitivity to any parasitic coupling of voltage spikes onto the SET pin. Note that any bypass capacitor leakage deteriorates the LT8622S/LT8624S's DC regulation. Capacitor leakage of even 100nA is a 0.1% DC error. Therefore, it is recommended to use a good quality, low leakage ceramic capacitor.

Using a SET pin bypass capacitor also soft-starts the output and limits inrush current. Soft-starting the output prevents a current surge on the input supply. The SET pin capacitor and resistor values set the ramp-up time of the reference voltage, and the output voltage tracks this voltage. The SET pin resistor size is determined by the application's desired output voltage; however, the capacitor size may be selected to achieve the desired ramp-up time. It is important to consider that the size of the SET pin capacitor also plays a role in noise performance, which is typically the more important factor in determining the size of this capacitor.

Ceramics are manufactured with a variety of dielectrics, each with a different behavior across temperature and applied voltage. Care should be taken when selecting a ceramic capacitor for bypassing the SET pin, as this is a critical component. An X7R (or better) ceramic capacitor is strongly recommended for its superior stability across temperature and DC voltage bias. Additionally, larger case sizes are recommended for better DC bias and AC voltage characteristics.

As shown in [Figure 60](#), capacitor DC bias characteristics tend to improve as component case size increases.

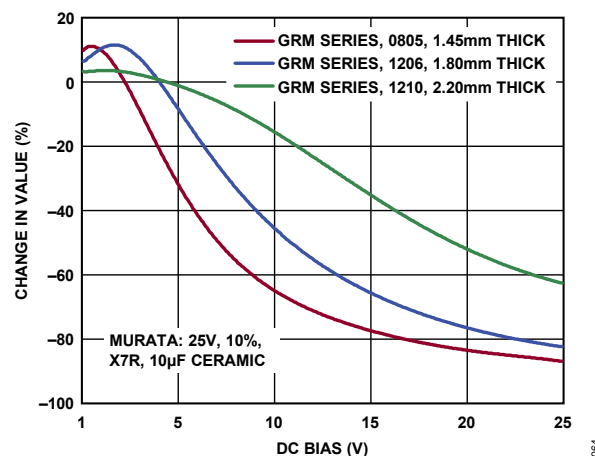

Figure 60. Capacitor Voltage Coefficient for Different Case Sizes

Larger case sizes are also beneficial for improved AC voltage characteristics. Capacitor values are often rated at 1V_{RMS} of AC voltage, and can drop significantly when operating near 0V_{RMS}, which is the operating condition of a bypass capacitor.

As shown in [Figure 61](#), larger case sizes tend to experience a smaller capacitance drop when operating near 0V_{RMS}. Therefore, an 0805 or larger ceramic capacitor should be used for the SET pin bypass capacitor for best performance. A larger desired capacitance value may require larger case sizes; for example, a 4.7µF value should use 1206 or larger.

Table 7 shows some recommended SET pin capacitors.

Table 7. Suggested SET Capacitor Part Numbers

PART DESCRIPTION	MANUFACTURER/PART NUMBER
1 μ F, X7R, 35V, 0805	MURATA, GRM219R7YA105KA12
4.7 μ F, X7R, 50V, 1206	MURATA, GRM31CR71H475MA12
10 μ F, X7R, 100V, 1210	MURATA, GRM32EC72A106KE05

For high vibration environments, non-piezoelectrically responsive capacitors should be used at the SET pin for optimal performance. A piezoelectric ceramic capacitor generates voltage across its terminals due to mechanical stress upon it, induced by mechanical vibrations or thermal transients. Film capacitors are the preferred option. If a ceramic must be used, soft-termination ceramics are available which reduce the sensitivity to the piezo-electric effect.

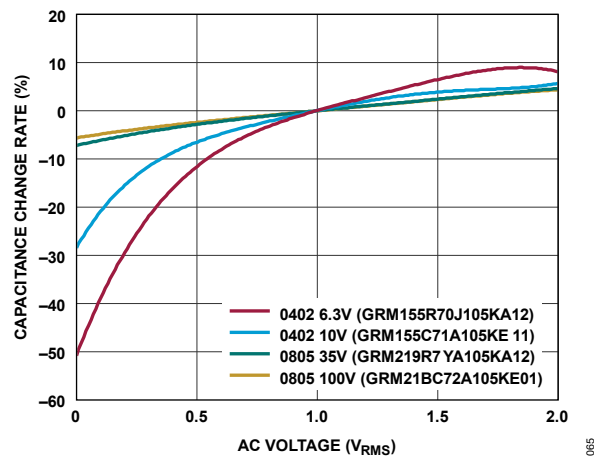

(a) Rated Capacitance = 1 μ F

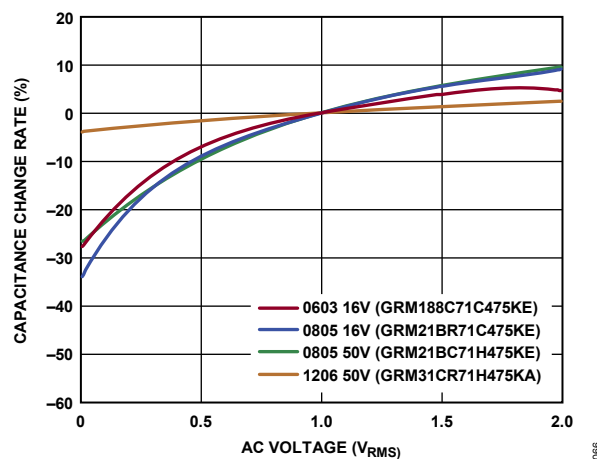

(b) Rated Capacitance = 4.7 μ F

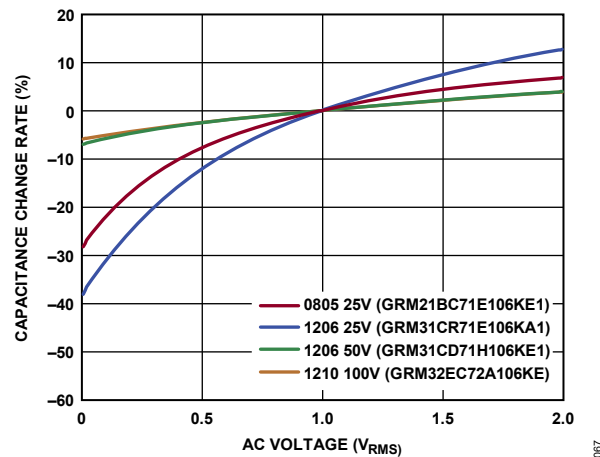
(c) Rated Capacitance = 10 μ F**Figure 61. AC Voltage Characteristics for Different Capacitor Case Sizes**

Without fast start-up enabled, the R_c time constant, formed by the SET pin resistor and capacitor, controls soft-start time. Connect the PGFB pin to 0.5V to disable fast start-up. The ramp-up rate from 0% to 90% of nominal V_{OUT} is given by Equation 10.

$$t_{\text{START_NO_FAST_START-UP}} = 2.3 \cdot R_{\text{SET}} \cdot C_{\text{SET}} \quad (10)$$

With fast-start-up enabled, the start-up time can be significantly reduced, with the ramp-up time from 0% to 90% of the nominal V_{OUT} given by Equation 11. See the [Typical Performance Characteristics](#) for how the 2.7mA Fast Start-up current varies with temperature and SV_{IN} - V_{SET} differential voltage.

$$t_{\text{START_FAST_START-UP}} = \frac{100\mu\text{A} \cdot R_{\text{SET}} \cdot C_{\text{SET}}}{2.7\text{mA}} \quad (11)$$

In most applications, fast start-up is enabled, in which case a minimum SET capacitor size of 1 μ F is recommended for preventing reference voltage overcharge as well as ensuring good noise performance.

Soft-Start and Power Sequencing

As discussed in the Set Pin (Bypass) Capacitance: Noise, Transient Response and Soft-Start section, soft-start is achieved through the controlled ramp-up time of the SET pin voltage. Soft-start is guaranteed when PV_{IN} and SV_{IN} are tied together.

When PV_{IN} and SV_{IN} are powered by independent supplies, power sequencing must be considered to guarantee soft-start. The SET pin voltage should start at 0V when PV_{IN} is applied. To guarantee soft-start, do not power PV_{IN} last when sequencing PV_{IN} , SV_{IN} , and EN/UVLO. An example of a specific case to avoid is having SV_{IN} and EN/UVLO powered up before PV_{IN} ; in this instance, the SET pin voltage will have risen to a voltage greater than 0V when PV_{IN} is applied, and the LT8622S/LT8624S will not soft-start correctly.

Fast Start-Up

For ultralow noise applications that require low 1/f noise (i.e., at frequencies below 100Hz), a larger value SET pin capacitor is required, up to 22 μ F. A larger value capacitor can be used, but care should be taken regarding leakage. While normally larger capacitors would significantly increase the regulator's start-up time, the LT8622S/LT8624S incorporates fast start-up circuitry that increases the SET pin current to about 2.7mA during start-up.

Upon start-up, the 2.7mA current source remains engaged while PGFB is below the power good start-up threshold ($V_{PGL_STARTUP}$) of 486.5mV, unless the regulator is in thermal shutdown, SV_{IN} is too low, or $INTV_{CC}$ has fallen too low.

The fast start-up circuit is permanently disabled once PGFB rises above $V_{PGL_STARTUP}$ until either the part is powered down, or the part is placed into shutdown by pulling the EN/UVLO pin below 1.29V.

There is one more condition under which the 2.7mA current source is disabled during start-up. The purpose of this is to prevent overcharging V_{SET} . Since the part assumes that the PGFB pin is an accurate indication of the voltage on the SET pin, it assumes that V_{OUTS} follows V_{SET} closely. However, this may not always be the case; for example, if the output capacitance is very large or if, for some reason, the output is temporarily shorted to the GND. Therefore, fast charge is disabled whenever the V_C pin reaches its maximum value, indicating V_{SET} significantly exceeds V_{OUTS} . This prevents incorrect behavior where the 2.7mA current source stays on even when V_{SET} has risen above its intended final value.

This means there is also a minimum SET capacitor requirement for using the fast start-up without overcharging the reference voltage. This will depend on the compensation network, as the part is depending on the V_C pin voltage rising to its maximum value to inform the part to pause fast start-up.

The recommended minimum required SET capacitance value to prevent overcharging the reference voltage during start-up is given in Equation 12.

$$\text{Minimum } C_{SET} = 27 \cdot \frac{C_{COMP}}{V_{SET}} \quad (12)$$

If programmable power good and fast start-up capabilities are not required, the PGFB pin must be connected to 0.5V.

Programmable Power Good

As illustrated in the *Block Diagram*, the power good threshold is user programmable using the ratio of two external resistors, $R_{PGFB(BOT)}$ and $R_{PGFB(TOP)}$ (see Equation 13).

$$V_{OUT(PG_THRESHOLD)} = 0.5V \cdot \left(1 + \frac{R_{PGFB(TOP)}}{R_{PGFB(BOT)}}\right) + I_{PGFB} \cdot R_{PGFB(TOP)} \quad (13)$$

If the PGFB pin increases above 537.5mV or decreases below 462.5mV, the open-drain PG pin asserts and becomes low impedance, indicating power is bad. The power good comparator has hysteresis of 10mV. The PGFB pin current (I_{PGFB}) from the Electrical Characteristics table must be considered when determining the resistor divider network. Note that the programmable power good and fast startup capabilities are disabled when PGFB is tied to 0.5V or when the device is in shutdown.

The PGFB pin current (I_{PGFB}) can be ignored if $R_{PGFB(BOT)}$ is less than 50k Ω . [Table 8](#) suggests some 1% PGFB resistor divider values for common V_{OUT} configurations.

Table 8. Suggested PGFB Resistor Divider Values

V_{OUT} (V)	$R_{PGFB(TOP)}$ (k Ω)	$R_{PGFB(BOT)}$ (k Ω)
0.8	29.4	48.7
0.9	39.2	48.7
1	49.9	49.9
1.2	69.8	49.9
1.8	130	49.9
3.3	280	49.9
5	453	49.9

Multiphase Operation

For output loads that demand more current, multiple LT8622S/LT8624S can be connected in parallel to the same output. To do this, the V_C and O_{UTS} pins are connected together, and each LT8622S/LT8624S's SW node is connected to the common output through its own inductor. The CLKOUT signal can be connected to the SYNC/MODE pin of the following LT8622S/LT8624S to line up both the frequency and the phase of the entire system. Tying the PHMODE pin to GND, INT V_{CC} , or floating the pin generates a phase difference between the LT8622S/LT8624S's internal clock and CLKOUT of 180°, 90°, or 120°, respectively, which corresponds to 2-phase, 4-phase, or 3-phase operation. A total of 12 phases can be paralleled to run simultaneously out-of-phase with respect to each other by programming the PHMODE pin of each LT8622S/LT8624S to different voltage levels. During FCM and synchronization modes, all devices operate at the same frequency. [Figure 62](#) shows a 2-phase application in which two LT8624S are paralleled to produce a single output capable of up to 8A.

Due to the current reference architecture of the LT8622S/LT8624S, the SET pins can also be tied together for better noise performance in the low frequency range, reduced component count, and superior current sharing between the phases due to the use of a common reference.

If two SET pins are connected together, as in [Figure 62](#), the total current running through R_{SET} will be 200 μ A. The R_{SET} value should be sized accordingly; in this case, for 1 V_{OUT} , an R_{SET} value of 5k Ω is required.

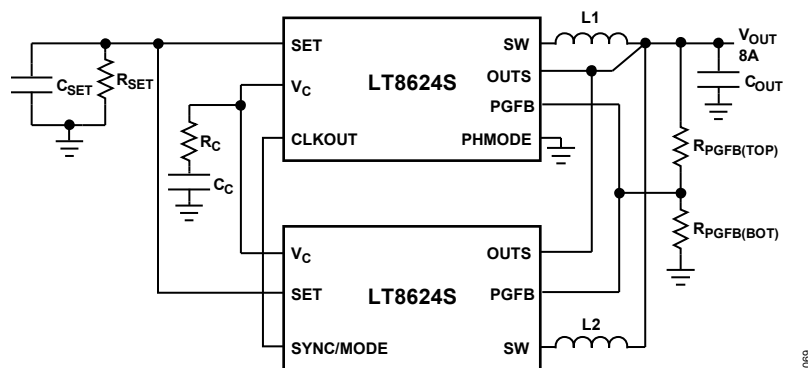

Figure 62. Paralleling Two LT8624S Devices

Shorted and Reversed Input Protection

The LT8622S/LT8624S will tolerate a shorted output. The bottom switch current is monitored such that if the inductor current is beyond safe levels, switching on of the top switch will be delayed until the inductor current falls to safe levels.

There is another situation to consider in systems where the output is held high when the input to the LT8622S/LT8624S is absent. This occurs in battery charging applications or in battery backup systems where a battery or some other supply is diode ORed with the LT8622S/LT8624S's output. If the PV_{IN} pin is allowed to float and the EN/UVLO pin is held high, then the LT8622S/LT8624S's internal circuitry will pull its quiescent current through its SW pin. This is acceptable if the system can tolerate current draw in this state. If the EN/UVLO pin is grounded, the SW pin current drops to ~50 μ A.

However, if the PV_{IN} pin is grounded while the output is held high, regardless of EN/UVLO, parasitic body diodes inside the LT8622S/LT8624S can pull current from the output through the SW pin and the PV_{IN} pin.

Figure 63 shows a connection of the PV_{IN} and EN/UVLO pins which allows the LT8622S/LT8624S to run only when the input voltage is present and protects against a shorted or reversed input.

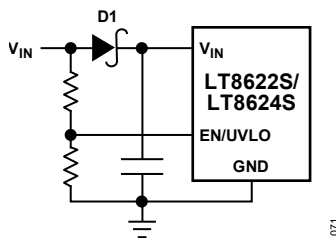

Figure 63. Reverse V_{IN} Protection

Thermal Considerations

For higher ambient temperatures, care should be taken in the layout of the PCB to ensure good heat sinking of the LT8622S/LT8624S. The exposed pad on the bottom of the package should be soldered to a ground plane. This ground should be connected to large copper layers below with thermal vias; these layers will spread heat dissipated by the LT8622S/LT8624S. Placing additional vias can reduce thermal resistance further. The maximum load current should be derated as the ambient temperature approaches the maximum junction rating. Power dissipation within the LT8622S/LT8624S can be estimated by calculating the total power loss from an efficiency measurement and subtracting the inductor loss. The die temperature is calculated by multiplying the LT8622S/LT8624S power dissipation by the thermal resistance from junction to ambient.

The internal overtemperature protection monitors the junction temperature of the LT8622S/LT8624S. If the junction temperature reaches approximately 165 °C, the LT8622S/LT8624S stops switching and indicates a fault condition until the temperature drops about 5 °C cooler.

Temperature rise of the LT8622S/LT8624S is worst when operating at high load, high PV_{IN} , and high switching frequency. If the case temperature is too high for a given application, then either PV_{IN} , switching frequency, or load current can be decreased to reduce the temperature to an appropriate level. Figure 64 shows examples of how case temperature rise can be managed by reducing load.

The LT8622S/LT8624S's top switch current limit decreases with higher duty cycle operation for slope compensation. This also limits the output current the LT8622S/LT8624S can deliver for a given application. See curve in [Typical Performance Characteristics](#).

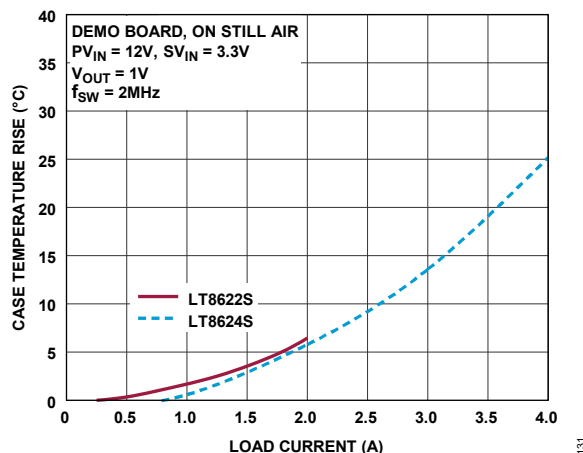

Figure 64. LT8622S/LT8624S Case Temperature Rise

TYPICAL APPLICATIONS

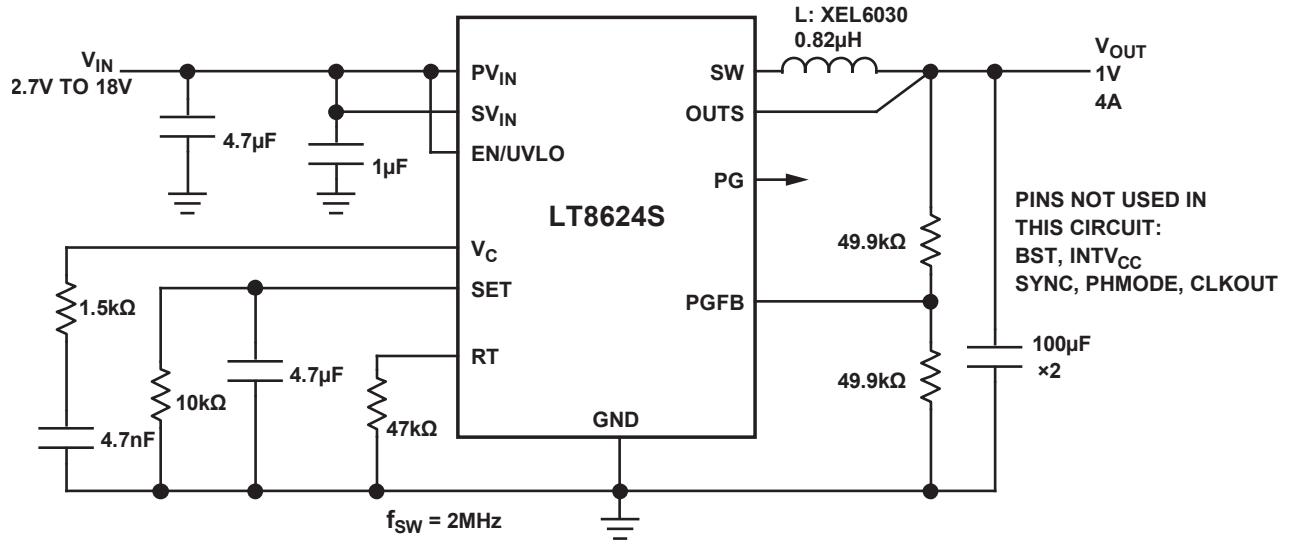
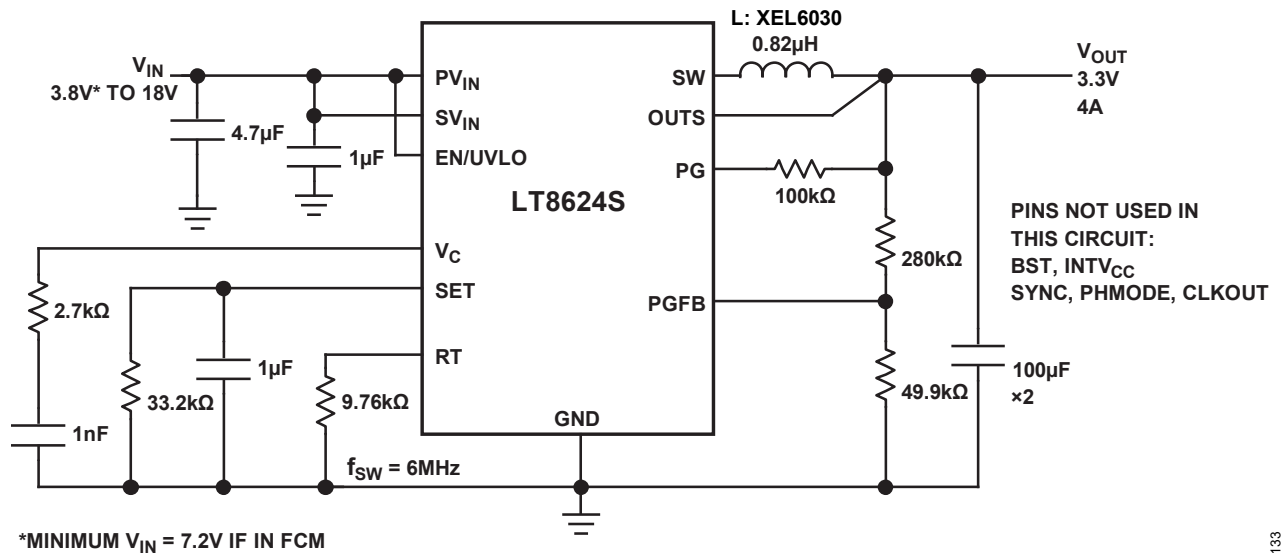

Figure 65. 1V 4A 2MHz Step-Down Converter with Soft-Start, Fast Start-Up and Power Good

165



*MINIMUM $V_{IN} = 7.2V$ IF IN FCM

Figure 66. 3.3V 4A 6MHz Step-Down Converter with Soft-Start, Fast Start-Up and Power Good

133

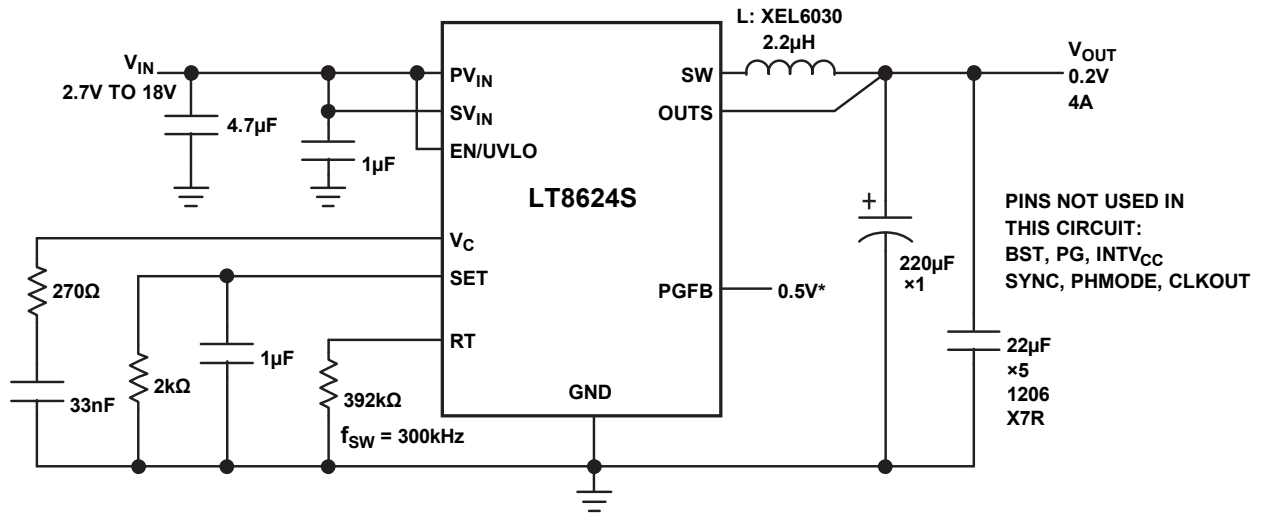

*NOTE THAT APPLICATIONS WITH V_{OUT} BELOW 0.5V WILL NOT BE ABLE TO USE THE POWER GOOD AND FAST-STARTUP FUNCTIONALITIES AND MUST TIE PGFB TO 0.5V TO DISABLE THESE FUNCTIONS CORRECTLY.

Figure 67. 0.2V 4A 300kHz Step-Down Converter with Soft-Start

134

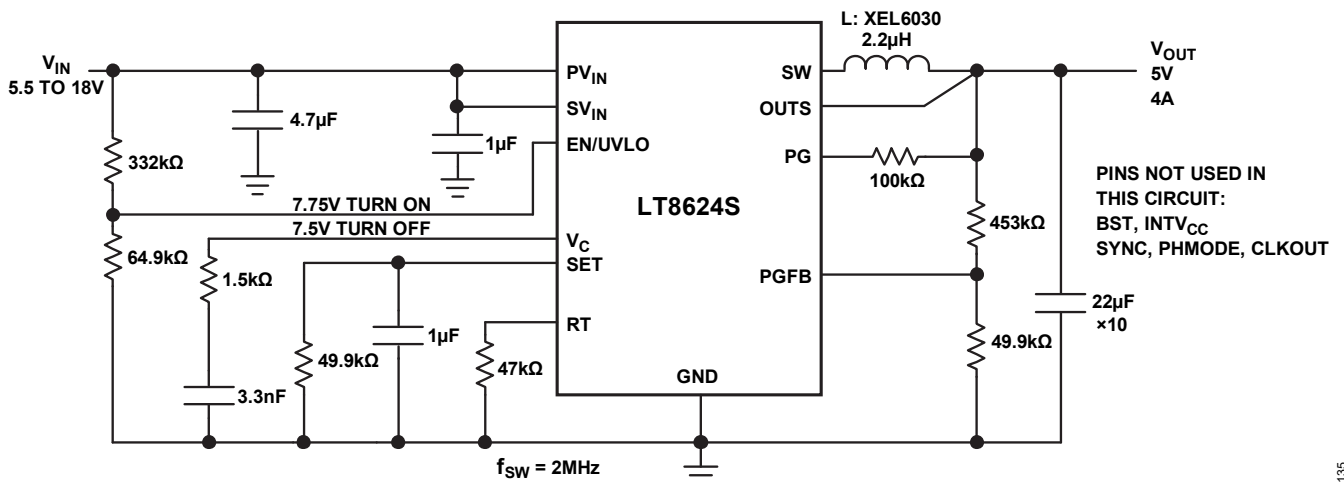

Figure 68. 5V 4A 2MHz Step-Down Converter with Soft-Start, Fast Start-Up, Power Good and UVLO

135

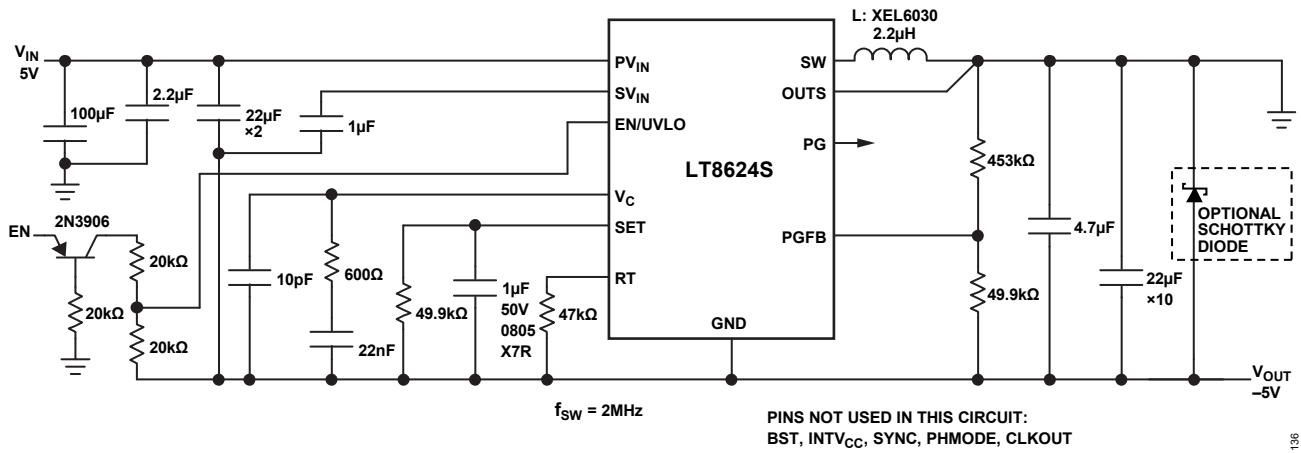
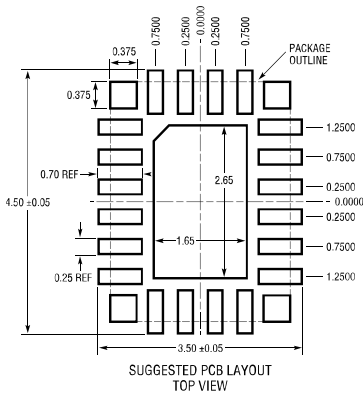
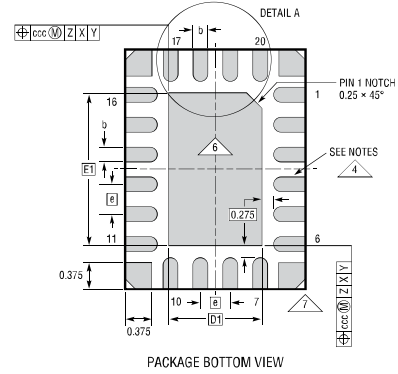
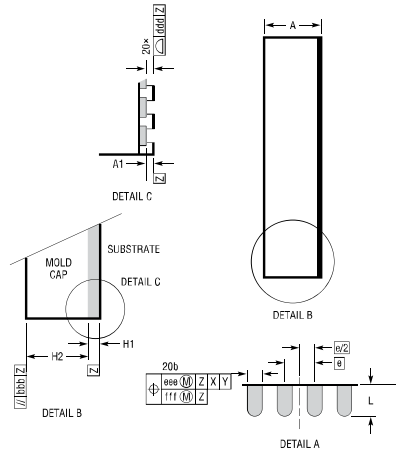
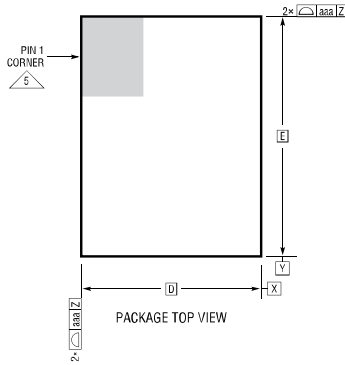

Figure 69. Negative 5V 4A 2MHz Step-Down Converter with Soft-Start, Fast Start-Up and Power Good

OUTLINE DIMENSIONS

LQFN Package
20-Lead (3mm × 4mm × 0.95mm)
 (Reference LTC DWG # 05-08-1689 Rev 0)



DIMENSIONS				
SYMBOL	MIN	NOM	MAX	NOTES
A	0.85	0.95	1.05	
A1	0.01	0.02	0.03	
L	0.30	0.40	0.50	
b	0.22	0.25	0.28	
D		3.00		
E		4.00		
D1		1.65		
E1		2.65		
e		0.50		
H1		0.25 REF		SUBSTRATE THK
H2		0.70 REF		MOLD CAP HT
aaa			0.10	
bbb			0.10	
ccc			0.10	
ddd			0.10	
eee			0.15	
fff			0.08	

- NOTES:
1. DIMENSIONING AND TOLERANCING PER ASME Y14.5M-1994
 2. ALL DIMENSIONS ARE IN MILLIMETERS
 3. PRIMARY DATUM -Z- IS SEATING PLANE
 4. METAL FEATURES UNDER THE SOLDER MASK OPENING NOT SHOWN SO AS NOT TO OBSCURE THESE TERMINALS AND HEAT FEATURES
 5. DETAILS OF PIN 1 IDENTIFIER ARE OPTIONAL, BUT MUST BE LOCATED WITHIN THE ZONE INDICATED. THE PIN 1 IDENTIFIER MAY BE EITHER A MOLD OR MARKED FEATURE
 6. THE EXPOSED HEAT FEATURE MAY HAVE OPTIONAL CORNER RADII
 7. CORNER SUPPORT PAD CHAMFER IS OPTIONAL

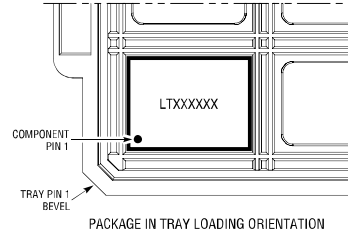

LQFN 20 0519 REV 0

ORDERING GUIDE

Table 9. Ordering Guide

PART NUMBER	TAPE AND REEL	PAD OR BALL FINISH	PART MARKING*		PACKAGE TYPE**	MSL RATING	TEMPERATURE RANGE ⁽²⁾
			DEVICE	FINISH CODE			
LT8622SAV#PBF	LT8622SAV#TRPBF	Au (RoHS)	8622S	e4	LQFN (Laminate Package with QFN Footprint)	3	-40°C to 125°C
LT8624SAV#PBF	LT8624SAV#TRPBF		8624S				

- ▶ Contact the factory for parts specified with wider operating temperature ranges. *Pad or ball finish code is per IPC/JEDEC J-STD-609.
- ▶ *The temperature grade is identified by a label on the shipping container.
- ▶ [Recommended LGA and BGA PCB Assembly and Manufacturing Procedures](#)
- ▶ [LGA and BGA Package and Tray Drawings](#)

Tape and reel specifications. Some packages are available in 500 unit reels through designated sales channels with #TRMPBF suffix.

Parts ending with PBF are RoHS and WEEE compliant. **The LT8622S/LT8624S package has the same dimensions as a standard 4mm × 3mm QFN package.

RELATED PARTS

PART	DESCRIPTION	COMMENTS
LT8625S	18V, 8A Synchronous Step-Down Silent Switcher 3 with Ultralow Noise Reference	4μVRMS Noise, V_{IN} = 2.7V to 18V, $V_{OUT(MIN)}$ = 0V, I_Q = 2.8mA, 4mm x 3mm LQFN-20
LT8625SP/ LT8625SP-1	18V, 8A Synchronous Step-Down Silent Switcher 3 with Ultralow Noise Reference	4μVRMS Noise, V_{IN} = 2.7V to 18V, $V_{OUT(MIN)}$ = 0V, I_Q = 2.8mA, 4mm x 3mm LQFN-20 or 4mm x 4mm LQFN-24
LT8627SP	18V, 16A Synchronous Step-Down Silent Switcher 3 with Ultralow Noise Reference	4μVRMS Noise, V_{IN} = 2.8V to 18V, $V_{OUT(MIN)}$ = 0V, I_Q = 3.2mA, 4mm × 4mm LQFN-24
LT8642S	18V, 10A Synchronous Step-Down Silent Switcher 2 Regulator	96% Efficiency, V_{IN} : 2.8V to 18V, $V_{OUT(MIN)}$ = 0.6V, I_Q = 240μA, I_{SD} < 1μA, 4mm × 4mm LQFN-24
LTC7151S	20V, 15A Synchronous Step-Down Silent Switcher 2 Regulator	92.5% Efficiency, V_{IN} : 3.1V to 20V, $V_{OUT(MIN)}$ = 0.5V, I_Q = 2mA, I_{SD} < 20μA, 4mm × 5mm LQFN-28
LTC7150S	20V, 20A Synchronous Step-Down Silent Switcher 2 Regulator	92% Efficiency, V_{IN} : 3.1V to 20V, $V_{OUT(MIN)}$ = 0.6V, I_Q = 2mA, I_{SD} ≤ 40μA, Differential Remote Sense, 6mm × 5mm BGA
LT3042	20V, 200mA, Ultralow Noise Ultrahigh PSRR Linear Regulator	0.8μVRMS Noise and 79dB PSRR at 1MHz, V_{IN} = 1.8V to 20V, 350mV Dropout Voltage, Programmable Current Limit and PowerGood, 3mm × 3mm DFN and MSOP Packages
LT3045	20V, 500mA, Ultralow Noise Ultrahigh PSRR Linear Regulator	0.8μVRMS Noise and 75dB PSRR at 1MHz, V_{IN} = 1.8V to 20V, 260mV Dropout Voltage, 3mm × 3mm DFN and MSOP Packages
LT8652S	18V, Dual 8.5A, 94% Efficiency, 2.2MHz Synchronous Silent Switcher 2 Step-Down DC/DC Converter with I_Q = 16μA	V_{IN} = 3V to 18V, $V_{OUT(MIN)}$ = 0.6V, I_Q = 16μA, I_{SD} = 6μA, 4mm × 7mm LQFN-36 Package
LTC3636	20V, Dual 6A Synchronous Step-Down Regulator	95% Efficiency, V_{IN} : 3.1V to 17V, $V_{OUT(MIN)}$ = 0.6V, I_Q < 8μA (Both Channels Enabled), I_{SD} < 1μA, 3mm × 5mm QFN-24 Package

LT8640S/ LT8643S	42V, 6A Synchronous Step-Down Silent Switcher 2 with $I_Q = 2.5\mu\text{A}$	$V_{IN(MIN)} = 3.4\text{V}$, $V_{IN(MAX)} = 42\text{V}$, $V_{OUT(MIN)} = 0.97\text{V}$, $I_Q = 2.5\mu\text{A}$, $I_{SD} < 1\mu\text{A}$, 4mm × 4mm LQFN-24
LT8645S/ LT8646S	65V, 8A, Synchronous Step-Down Silent Switcher 2 with $I_Q = 2.5\mu\text{A}$	$V_{IN(MIN)} = 3.4\text{V}$, $V_{IN(MAX)} = 65\text{V}$, $V_{OUT(MIN)} = 0.97\text{V}$, $I_Q = 2.5\mu\text{A}$, $I_{SD} < 1\mu\text{A}$, 6mm × 4mm LQFN-32
LT8609/ LT8609A	42V, 2A, 94% Efficiency, 2.2MHz Synchronous MicroPower Step-Down DC/DC Converter with $I_Q = 2.5\mu\text{A}$	$V_{IN(MIN)} = 3\text{V}$, $V_{IN(MAX)} = 42\text{V}$, $V_{OUT(MIN)} = 0.8\text{V}$, $I_Q = 2.5\mu\text{A}$, $I_{SD} < 1\mu\text{A}$, MSOP-10E

ALL INFORMATION CONTAINED HEREIN IS PROVIDED "AS IS" WITHOUT REPRESENTATION OR WARRANTY. NO RESPONSIBILITY IS ASSUMED BY ANALOG DEVICES FOR ITS USE, NOR FOR ANY INFRINGEMENTS OF PATENTS OR OTHER RIGHTS OF THIRD PARTIES THAT MAY RESULT FROM ITS USE. SPECIFICATIONS ARE SUBJECT TO CHANGE WITHOUT NOTICE. NO LICENCE, EITHER EXPRESSED OR IMPLIED, IS GRANTED UNDER ANY ADI PATENT RIGHT, COPYRIGHT, MASK WORK RIGHT, OR ANY OTHER ADI INTELLECTUAL PROPERTY RIGHT RELATING TO ANY COMBINATION, MACHINE, OR PROCESS, IN WHICH ADI PRODUCTS OR SERVICES ARE USED. TRADEMARKS AND REGISTERED TRADEMARKS ARE THE PROPERTY OF THEIR RESPECTIVE OWNERS. ALL ANALOG DEVICES PRODUCTS CONTAINED HEREIN ARE SUBJECT TO RELEASE AND AVAILABILITY.