

Signal and Power Isolated CAN Transceiver with Integrated Isolated DC-to-DC Converter

FEATURES

- ▶ 2.5 kV rms signal and power isolated CAN transceiver
- ▶ isoPower integrated isolated dc-to-dc converter
- ▶ 5 V operation on V_{CC}
- ▶ 5 V or 3.3 V operation on V_{IO}
- ▶ Complies with ISO 11898 standard
- ▶ High speed data rates of up to 1 Mbps
- ▶ Unpowered nodes do not disturb the bus
- ▶ Connect 110 or more nodes on the bus
- ▶ Slope control for reduced EMI
- ▶ Thermal shutdown protection
- ▶ High common-mode transient immunity: >25 kV/ μ s
- ▶ Safety and regulatory approvals
 - ▶ UL 1577
 - ▶ $V_{ISO} = 2500 V_{rms}$ for 1 minute
 - ▶ IEC/EN/CSA 62368-1
 - ▶ IEC/CSA 61010-1
 - ▶ CQC GB4943.1
 - ▶ DIN EN IEC 60747-17 (VDE 0884-17) (pending)
 - ▶ $V_{IORM} = 560 V_{peak}$
- ▶ Industrial operating temperature range ($-40^{\circ}C$ to $+85^{\circ}C$)
- ▶ Available in wide-body, 20-lead SOIC package

APPLICATIONS

- ▶ CAN data buses
- ▶ Industrial field networks

GENERAL DESCRIPTION

The ADM3053 is an isolated controller area network (CAN) physical layer transceiver with an integrated isolated dc-to-dc converter. The ADM3053 complies with the ISO 11898 standard.

The device employs Analog Devices, Inc., iCoupler® technology to combine a 2-channel isolator, a CAN transceiver, and Analog Devices isoPower® dc-to-dc converter into a single SOIC surface mount package. An on-chip oscillator outputs a pair of square waveforms that drive an internal transformer to provide isolated power. The device is powered by a single 5 V supply realizing a fully isolated CAN solution.

The ADM3053 creates a fully isolated interface between the CAN protocol controller and the physical layer bus. It is capable of running at data rates of up to 1 Mbps.

The device has current limiting and thermal shutdown features to protect against output short circuits. The part is fully specified over the industrial temperature range and is available in a [20-lead, wide-body SOIC package](#).

The ADM3053 contains isoPower technology that uses high-frequency switching elements to transfer power through the transformer. Special care must be taken during printed circuit board (PCB) layout to meet emissions standards. Refer to the [AN-0971 Application Note, Recommendations for Control of Radiated Emissions with isoPower Devices](#), for details on board layout considerations.

FUNCTIONAL BLOCK DIAGRAM

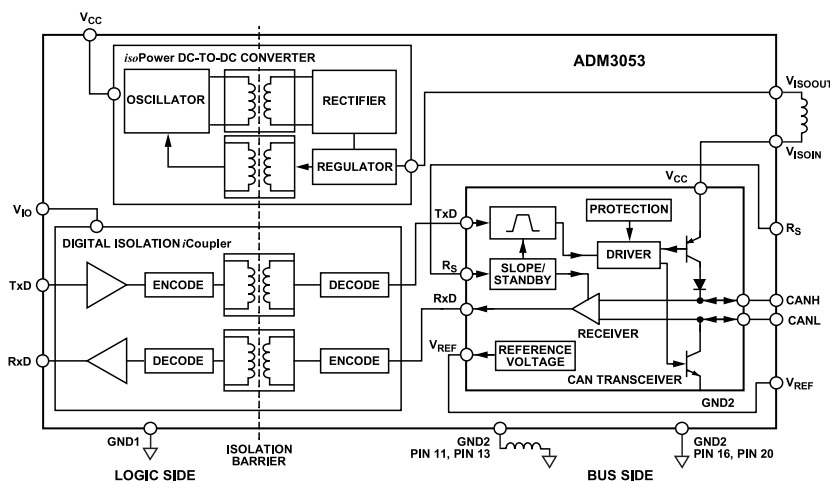

Figure 1.

TABLE OF CONTENTS

Features.....	1	CAN Transceiver Operation.....	13
Applications.....	1	Signal Isolation.....	13
General Description.....	1	Power Isolation.....	13
Functional Block Diagram.....	1	Truth Tables.....	13
Specifications.....	3	Thermal Shutdown.....	13
Timing Specifications.....	4	DC Correctness and Magnetic Field	
Switching Characteristics.....	4	Immunity.....	14
Regulatory Information.....	5	Applications Information.....	15
Insulation and Safety-Related Specifications.....	5	PCB Layout.....	15
DIN EN IEC 60747-17 (VDE 0884-17)		EMI Considerations.....	15
Insulation Characteristics.....	6	R _S Pin.....	15
Absolute Maximum Ratings.....	7	Insulation Lifetime.....	16
ESD Caution.....	7	Typical Applications.....	17
Pin Configuration and Function Descriptions.....	8	Outline Dimensions.....	18
Typical Performance Characteristics.....	9	Ordering Guide.....	18
Test Circuits.....	12	Evaluation Boards.....	18
Circuit Description.....	13		

REVISION HISTORY**10/2024—Rev. E to Rev. F**

Changes to Features Section.....	1
Changes to Regulatory Information Section and Table 3.....	5
Changes to Table 4.....	5
Changed VDE 0884 Insulation Characteristics Section to DIN EN IEC 60747-17 (VDE 0884-17)	
Insulation Characteristics Section.....	6
Changes to Table 5.....	6
Deleted Table 7; Renumbered Sequentially.....	7
Changes to Evaluation Boards.....	18

SPECIFICATIONS

All voltages are relative to their respective grounds; $4.5\text{ V} \leq V_{CC} \leq 5.5\text{ V}$; $3.0\text{ V} \leq V_{IO} \leq 5.5\text{ V}$. All minimum/maximum specifications apply over the entire recommended operation range, unless otherwise noted. All typical specifications are at $T_A = 25^\circ\text{C}$, $V_{CC} = 5\text{ V}$, and $V_{IO} = 5\text{ V}$ unless otherwise noted.

Table 1.

Parameter	Symbol	Min	Typ	Max	Unit	Test Conditions/Comments
SUPPLY CURRENT						
Logic Side isoPower Current						
Recessive State	I_{CC}		29	36	mA	$R_L = 60\ \Omega$, $R_S = \text{low}$, see Figure 25
Dominant State	I_{CC}		195	260	mA	$R_L = 60\ \Omega$, $R_S = \text{low}$, see Figure 25
TxD/RxD Data Rate 1 Mbps	I_{CC}		139	200	mA	$R_L = 60\ \Omega$, $R_S = \text{low}$, see Figure 25
Logic Side iCoupler Current						
TxD/RxD Data Rate 1 Mbps	I_{IO}		1.6	2.5	mA	
DRIVER						
Logic Inputs						
Input Voltage High	V_{IH}	$0.7 V_{IO}$			V	Output recessive
Input Voltage Low	V_{IL}			$0.25 V_{IO}$	V	Output dominant
CMOS Logic Input Currents	I_{IH} , I_{IL}			500	μA	TxD
Differential Outputs						
Recessive Bus Voltage	V_{CANL} , V_{CANH}	2.0		3.0	V	TxD = high, $R_L = \infty$, see Figure 22
CANH Output Voltage	V_{CANH}	2.75		4.5	V	TxD = low, see Figure 22
CANL Output Voltage	V_{CANL}	0.5		2.0	V	TxD = low, see Figure 22
Differential Output Voltage	V_{OD}	1.5		3.0	V	TxD = low, $R_L = 45\ \Omega$, see Figure 22
Short-Circuit Current, CANH	I_{SCCANH}			-200	mA	$V_{CANH} = -5\text{ V}$
Short-Circuit Current, CANL	I_{SCCANL}		-100	200	mA	$V_{CANH} = -36\text{ V}$ $V_{CANL} = 36\text{ V}$
RECEIVER						
Differential Inputs						
Differential Input Voltage Recessive	V_{IDR}	-1.0		+0.5	V	$-7\text{ V} < V_{CANL}$, $V_{CANH} < +12\text{ V}$, see Figure 23, $C_L = 15\text{ pF}$
Differential Input Voltage Dominant	V_{IDD}	0.9		5.0	V	$-7\text{ V} < V_{CANL}$, $V_{CANH} < +12\text{ V}$, see Figure 23, $C_L = 15\text{ pF}$
Input Voltage Hysteresis	V_{HYS}		150		mV	See Figure 3
CANH, CANL Input Resistance	R_{IN}	5		25	k Ω	
Differential Input Resistance	R_{DIFF}	20		100	k Ω	
Logic Outputs						
Output Low Voltage	V_{OL}		0.2	0.4	V	$I_{OUT} = 1.5\text{ mA}$
Output High Voltage	V_{OH}	$V_{IO} - 0.3$	$V_{IO} - 0.2$		V	$I_{OUT} = -1.5\text{ mA}$
Short Circuit Current	I_{OS}	7		85	mA	$V_{OUT} = \text{GND1 or } V_{IO}$
VOLTAGE REFERENCE						
Reference Output Voltage	V_{REF}	2.025		3.025	V	$ I_{REF} = 50\ \mu\text{A}$
COMMON-MODE TRANSIENT IMMUNITY¹						
		25			kV/ μs	$V_{CM} = 1\text{ kV}$, transient magnitude = 800 V
SLOPE CONTROL						
Current for Slope Control Mode	I_{SLOPE}	-10		-200	μA	
Slope Control Mode Voltage	V_{SLOPE}	1.8		3.3	V	

¹ CM is the maximum common-mode voltage slew rate that can be sustained while maintaining specification compliant operation. VCM is the common-mode potential difference between the logic and bus sides. The transient magnitude is the range over which the common mode is slewed. The common-mode voltage slew rates apply to both rising and falling common-mode voltage edges.

SPECIFICATIONS

TIMING SPECIFICATIONS

All voltages are relative to their respective ground; $3.0\text{ V} \leq V_{IO} \leq 5.5\text{ V}$; $4.5\text{ V} \leq V_{CC} \leq 5.5\text{ V}$. $T_A = -40^\circ\text{C}$ to $+85^\circ\text{C}$, unless otherwise noted.

Table 2.

Parameter	Symbol	Min	Typ	Max	Unit	Test Conditions/Comments
DRIVER						
Maximum Data Rate		1			Mbps	
Propagation Delay from TxD On to Bus Active	t_{onTxD}			90	ns	$R_S = 0\ \Omega$; see Figure 2 and Figure 24 $R_L = 60\ \Omega$, $C_L = 100\text{ pF}$
Propagation Delay from TxD Off to Bus Inactive	t_{offTxD}			120	ns	$R_S = 0\ \Omega$; see Figure 2 and Figure 24 $R_L = 60\ \Omega$, $C_L = 100\text{ pF}$
RECEIVER						
Propagation Delay from TxD On to Receiver Active	t_{onRxD}			200	ns	$R_S = 0\ \Omega$; see Figure 2
Propagation Delay from TxD Off to Receiver Inactive ¹	t_{offRxD}			630	ns	$R_S = 47\text{ k}\Omega$; see Figure 2
				250	ns	$R_S = 0\ \Omega$; see Figure 2
				480	ns	$R_S = 47\text{ k}\Omega$; see Figure 2
CANH, CANL SLEW RATE	$ SR $		7		V/ μs	$R_S = 47\text{ k}\Omega$

¹ Guaranteed by design and characterization.

SWITCHING CHARACTERISTICS

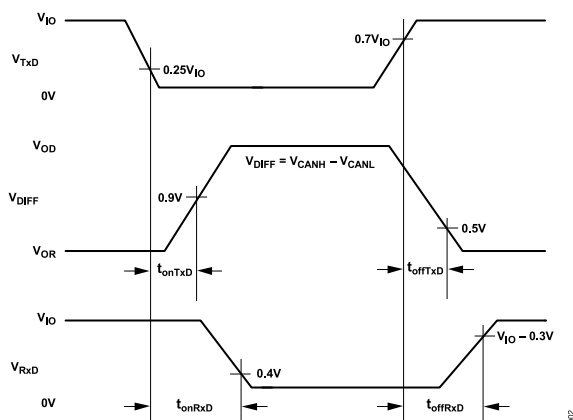

Figure 2. Driver Propagation Delay, Rise/Fall Timing

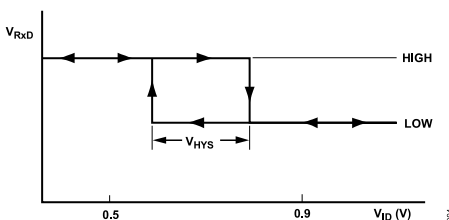

Figure 3. Receiver Input Hysteresis

SPECIFICATIONS

REGULATORY INFORMATION

The ADM3053 certification approvals are listed in [Table 6](#).

Table 3. ADM3053 Approvals

Organization	Approval Type	File
UL	UL 1577 Single protection, 2500 V _{rms} ¹	E214100
VDE (Pending)	DIN EN IEC 60747-17 (VDE 0884-17) Reinforced insulation, 560 V _{peak} ²	Certificate No. (pending)
CSA	IEC / EN / CSA 62368-1 Basic insulation, 600 V _{rms} Reinforced insulation, 300 V _{rms}	Certificate No. 205078
CQC	IEC/CSA 61010-1 Basic insulation, 600 V _{rms} Reinforced insulation, 300 V _{rms} CQC GB4943.1 Basic insulation, 760 V _{rms} Reinforced insulation, 380 V _{rms}	Certificate No. CQC17001164239

¹ In accordance with UL 1577, each ADM3053 is proof tested by applying an insulation voltage ≥ 3000 V_{rms} for 1 sec.

² In accordance with DIN EN IEC 60747-17 (VDE 0884-17), each ADM3053 is proof tested by applying an insulation test voltage ≥ 1050 V_{peak} for 1 sec (partial discharge detection limit = 5 pC).

INSULATION AND SAFETY-RELATED SPECIFICATIONS

Table 4.

Parameter	Symbol	Value	Unit	Test Conditions/Comments
Rated Dielectric Insulation Voltage		2500	V _{rms}	1-minute duration
Minimum External Air Gap (Clearance) ^{1,2}	L(I01)	6.4	mm	Measured from input terminals to output terminals, shortest distance through air
Minimum External Tracking (Creepage) ¹	L(I02)	6.4	mm	Measured from input terminals to output terminals, shortest distance along body
Minimum Internal Gap (Internal Clearance)		17	μm	Insulation distance through insulation
Tracking Resistance (Comparative Tracking Index) ³	CTI	>400	V	DIN IEC 112/VDE 0303-1
Isolation Group		II		Material group (DIN VDE 0110: 1989-01, Table 1)

¹ In accordance with IEC 62368-1 guidelines for the measurement of creepage and clearance distances for a pollution degree of 2 and altitudes ≤ 2000 m.

² Consideration must be given to pad layout to ensure the minimum required distance for clearance is maintained.

³ CTI rating for the ADM3053 is >400 V and a Material Group II isolation group.

SPECIFICATIONS

DIN EN IEC 60747-17 (VDE 0884-17) INSULATION CHARACTERISTICS

This isolator is suitable for basic electrical isolation only within the safety limit data. Maintenance of the safety data must be ensured by means of protective circuits.

Table 5.

Description	Test Conditions/Comments	Symbol	Characteristic	Unit
CLASSIFICATIONS				
Overvoltage Category per IEC 60664-1			I to IV	
$\leq 150 V_{rms}$			I to III	
$\leq 300 V_{rms}$			I to II	
$\leq 400 V_{rms}$			40/85/21	
Climatic Classification			2	
Pollution Degree	DIN VDE 0110, see Table 3			
VOLTAGE				
Maximum Repetitive Isolation Voltage		V_{IORM}	560	V_{PEAK}
Maximum Working Insulation Voltage		V_{IOWM}	396	V_{rms}
Input-to-Output Test Voltage		V_{IORM}		
Method b1	$V_{IORM} \times 1.875 = V_{PR}$, 100% production tested, $t_m = 1$ sec, partial discharge < 5 pC		1050	V_{PEAK}
Method a	$V_{IORM} \times 1.6$		896	V_{PEAK}
Method a	$V_{IORM} \times 1.2$		672	V_{PEAK}
Maximum Transient Isolation Voltage	(Transient overvoltage, $t_{TR} = 10$ sec)	V_{IOTM}	4000	V_{PEAK}
Maximum Impulse Voltage	Tested in air, 1.2 μ s/50 μ s waveform per IEC 61000-4-5	V_{IMP}	4000	V_{PEAK}
Maximum Surge Isolation Voltage	Tested in oil, 1.2 μ s/50 μ s waveform per IEC 61000-4-5 $V_{TEST} = V_{IOSM} \times 1.3$ OR ≥ 10 kV	V_{IOSM}	10000	V_{PEAK}
SAFETY-LIMITING VALUES				
Case Temperature	Maximum value allowed in the event of a failure	T_S	150	$^{\circ}C$
Input Current		$I_{S, INPUT}$	265	mA
Output Current		$I_{S, OUTPUT}$	335	mA
Insulation Resistance at T_S	$V_{IO} = 500$ V	R_S	$>10^9$	Ω

ABSOLUTE MAXIMUM RATINGS

$T_A = 25^\circ\text{C}$, unless otherwise noted. All voltages are relative to their respective ground.

Table 6.

Parameter	Rating
V_{CC}	-0.5 V to +6 V
V_{IO}	-0.5 V to +6 V
Digital Input Voltage, TxD	-0.5 V to $V_{IO} + 0.5$ V
Digital Output Voltage, RxD	-0.5 V to $V_{IO} + 0.5$ V
CANH, CANL	-36 V to +36 V
V_{REF}	-0.5 V to +6 V
R_S	-0.5 V to +6 V
Operating Temperature Range	-40°C to $+85^\circ\text{C}$
Storage Temperature Range	-55°C to $+150^\circ\text{C}$
ESD (Human Body Model)	3 kV
Lead Temperature	
Soldering (10 sec)	300°C
Vapor Phase (60 sec)	215°C
Infrared (15 sec)	220°C
θ_{JA} Thermal Impedance	53°C/W
T_J Junction Temperature	150°C

Stresses at or above those listed under Absolute Maximum Ratings may cause permanent damage to the product. This is a stress rating only; functional operation of the product at these or any other conditions above those indicated in the operational section of this specification is not implied. Operation beyond the maximum operating conditions for extended periods may affect product reliability.

ESD CAUTION

ESD (electrostatic discharge) sensitive device. Charged devices and circuit boards can discharge without detection. Although this product features patented or proprietary protection circuitry, damage may occur on devices subjected to high energy ESD. Therefore, proper ESD precautions should be taken to avoid performance degradation or loss of functionality.

PIN CONFIGURATION AND FUNCTION DESCRIPTIONS

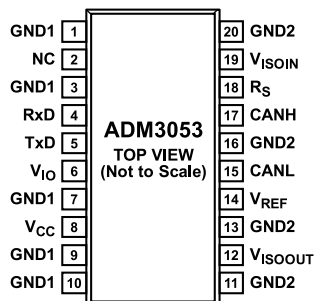

NOTES

1. NC = NO CONNECT. DO NOT CONNECT TO THIS PIN.
2. PIN 12 AND PIN 19 MUST BE CONNECTED EXTERNALLY.

005

Figure 4. Pin Configuration

Table 7. Pin Function Descriptions

Pin No.	Mnemonic	Description
1, 3, 7, 9, 10	GND1	Ground, Logic Side.
2	NC	No Connect. Do not connect to this pin.
4	RxD	Receiver Output Data.
5	TxD	Driver Input Data.
6	V _{IO}	iCoupler Power Supply. It is recommended that a 0.1 μ F and a 0.01 μ F decoupling capacitor be fitted between Pin 6 and GND1. See Figure 28 for layout recommendations.
8	V _{CC}	isoPower Power Supply. It is recommended that a 0.1 μ F and a 10 μ F decoupling capacitor be fitted between Pin 8 and Pin 9.
11, 13	GND2	Ground for Isolated DC-to-DC Converter. It is recommended to connect Pin 11 and Pin 13 together through one ferrite bead to the PCB ground.
12	V _{ISOOUT}	Isolated Power Supply Output. This pin must be connected externally to V _{ISOIN} . It is recommended that a ferrite bead reservoir capacitor of 10 μ F and a decoupling capacitor of 0.1 μ F be fitted between Pin 12 and Pin 11.
14	V _{REF}	Reference Voltage Output. It is recommended not to connect to this pin.
15	CANL	Low-Level CAN Voltage Input/Output.
16, 20	GND2	Ground, Bus Side.
17	CANH	High-Level CAN Voltage Input/Output.
18	R _S	Slope Control Pin. Short this pin to GND2 (Pin 16 or Pin 20) for full speed operation. Use a weak pull-down for slope control. An input high places the transceiver in standby. This pin must not be left floating.
19	V _{ISOIN}	Isolated Power Supply Input. This pin must be connected externally to V _{ISOOUT} . It is recommended this pin have a 0.1 μ F capacitor to GND2 (Pin 13 or Pin 11). Connect this pin through a ferrite bead and short trace length to V _{ISOIN} for operation.

TYPICAL PERFORMANCE CHARACTERISTICS

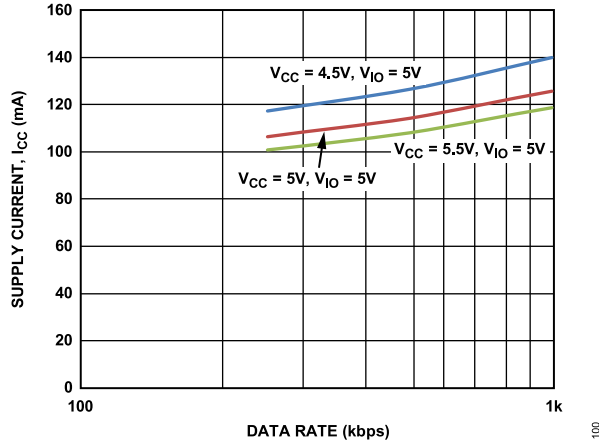

Figure 5. Supply Current, I_{CC} vs. Data Rate

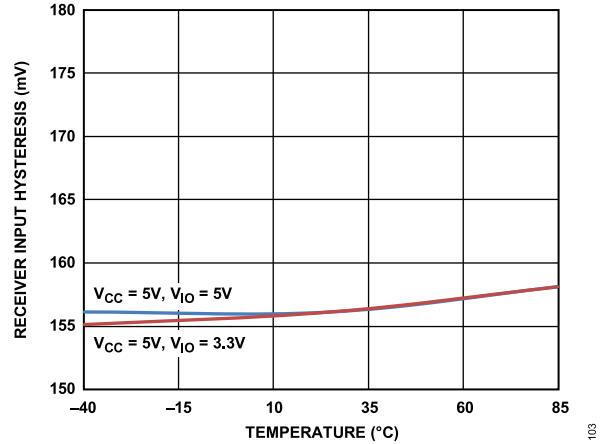

Figure 8. Receiver Input Hysteresis vs. Temperature

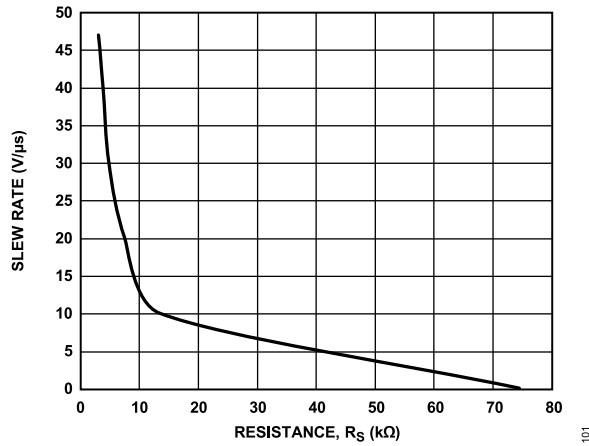

Figure 6. Driver Slew Rate vs. Resistance, R_S

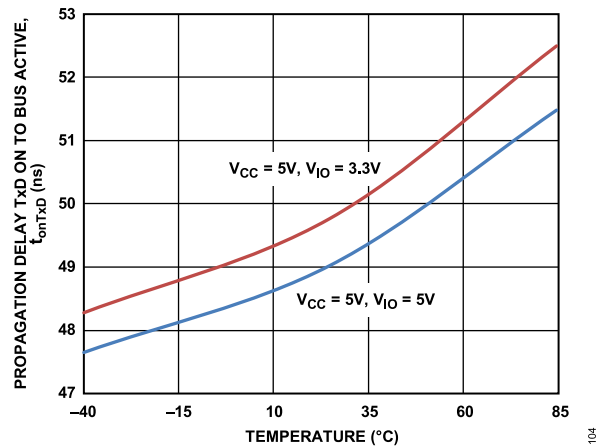

Figure 9. Propagation Delay from TxD On to Bus Active vs. Temperature

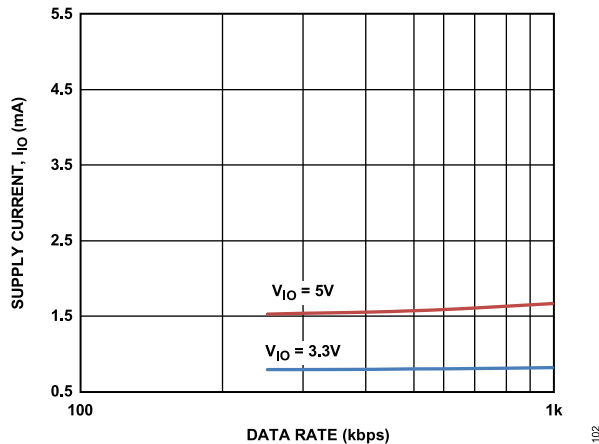

Figure 7. Supply Current, I_{IO} vs. Data Rate

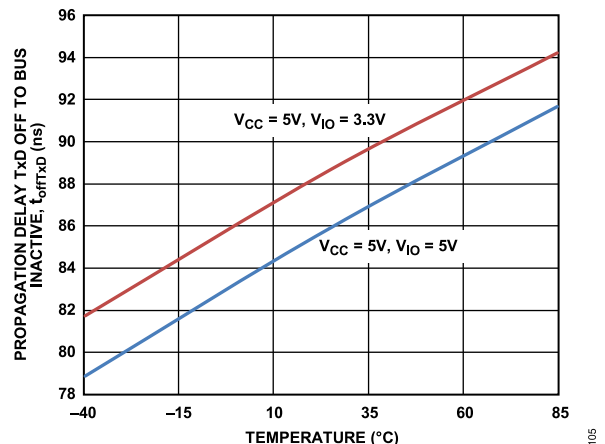

Figure 10. Propagation Delay from TxD Off to Bus Inactive vs. Temperature

TYPICAL PERFORMANCE CHARACTERISTICS

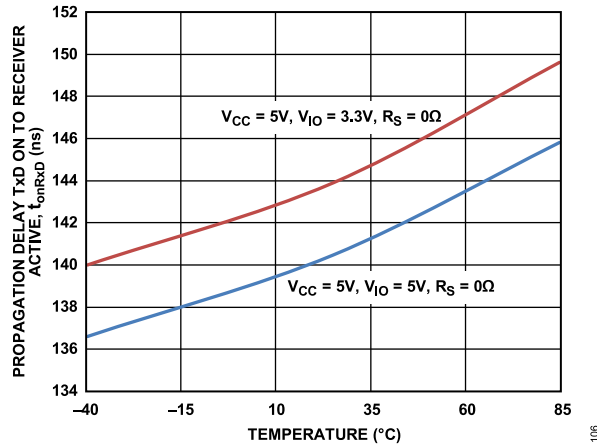

Figure 11. Propagation Delay from TxD On to Receiver Active vs. Temperature

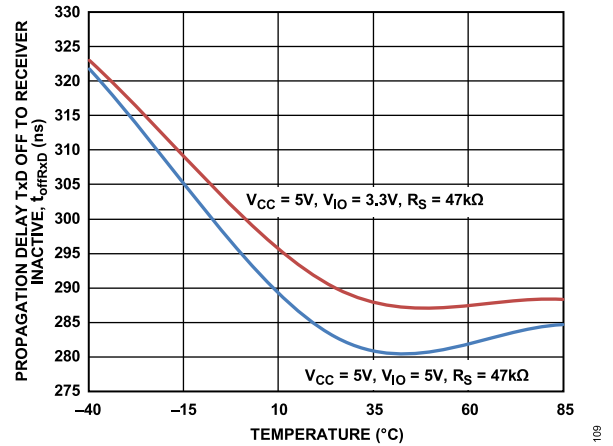

Figure 14. Propagation Delay from TxD Off to Receiver Inactive vs. Temperature

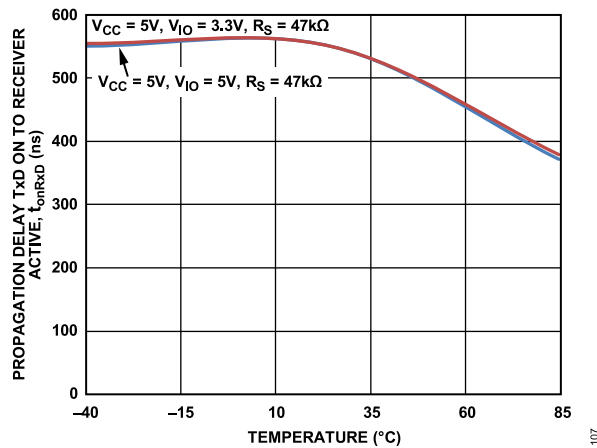

Figure 12. Propagation Delay from TxD On to Receiver Active vs. Temperature

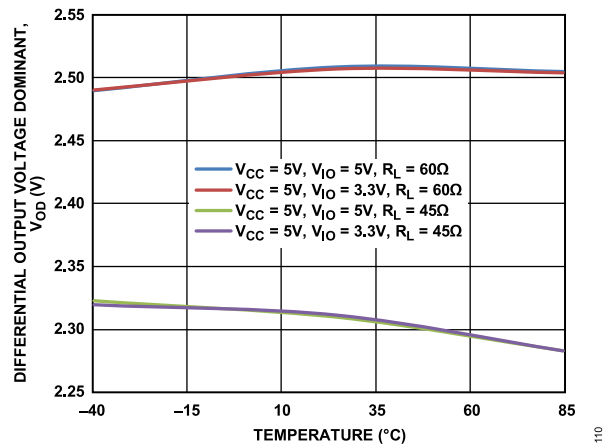

Figure 15. Differential Output Voltage Dominant vs. Temperature

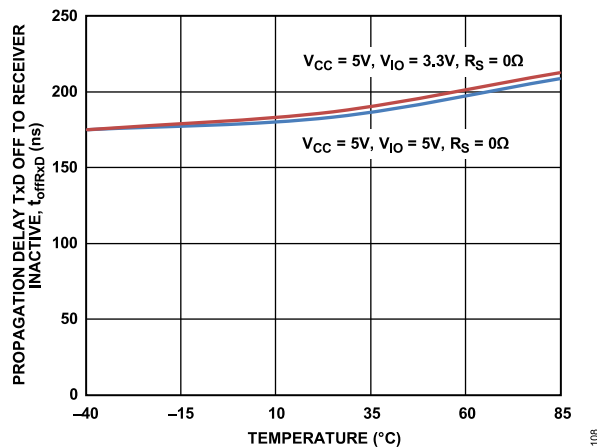

Figure 13. Propagation Delay from TxD Off to Receiver Inactive vs. Temperature

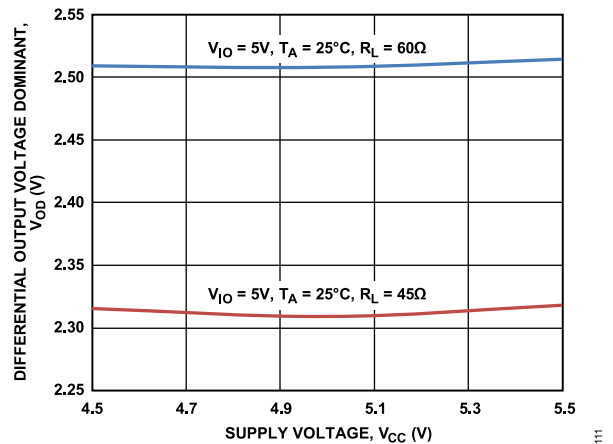

Figure 16. Differential Output Voltage Dominant vs. Supply Voltage, VCC

TYPICAL PERFORMANCE CHARACTERISTICS

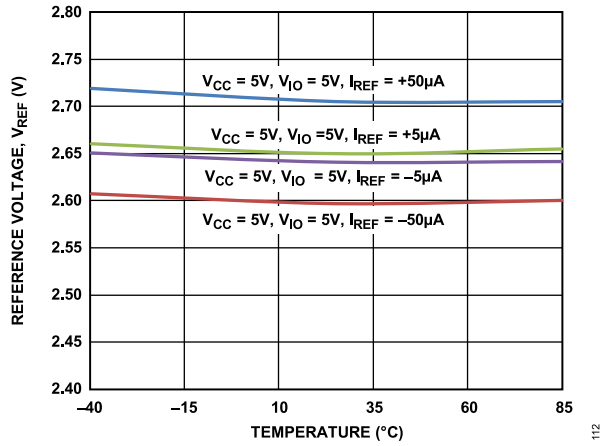

Figure 17. Reference Voltage vs. Temperature

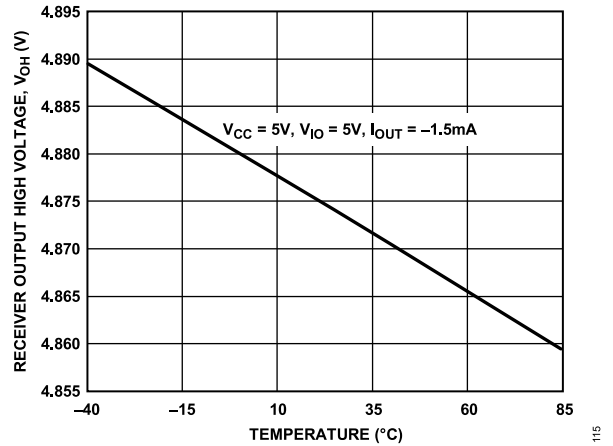

Figure 20. Receiver Output High Voltage vs. Temperature

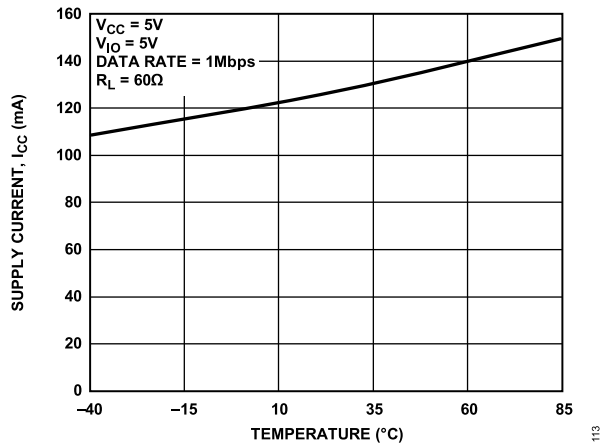

Figure 18. Supply Current I_{CC} vs. Temperature

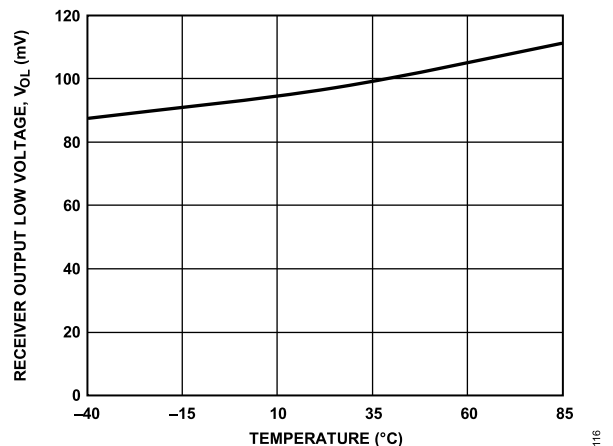

Figure 21. Receiver Output Low Voltage vs. Temperature

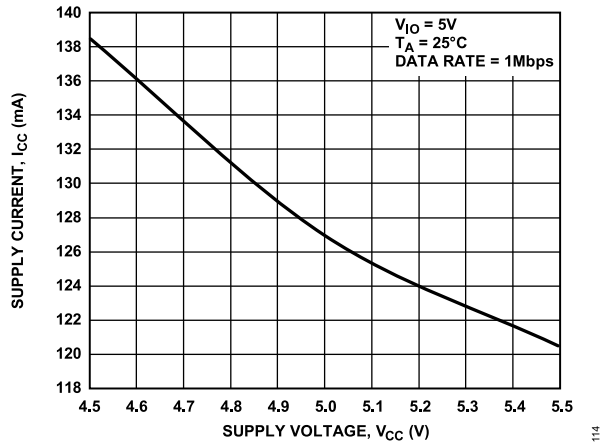

Figure 19. Supply Current, I_{CC} vs. Supply Voltage V_{CC}

TEST CIRCUITS

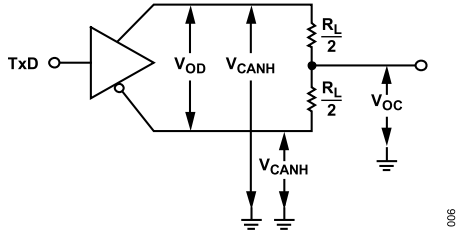

Figure 22. Driver Voltage Measurement

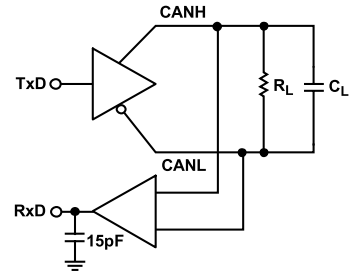

Figure 24. Switching Characteristics Measurements

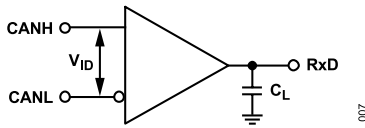

Figure 23. Receiver Voltage Measurements

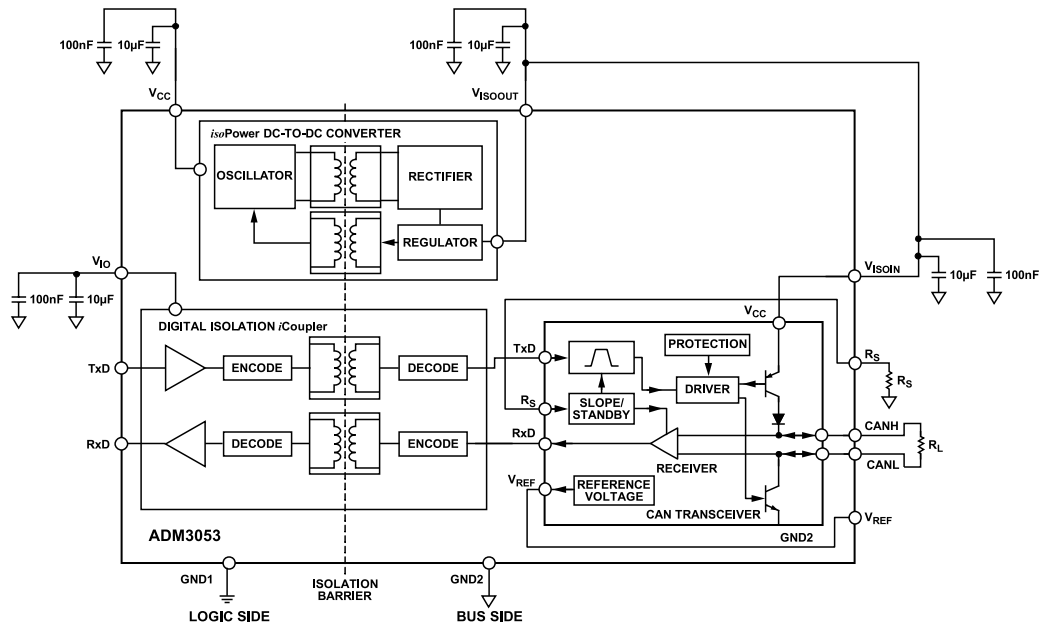

Figure 25. Supply Current Measurement Test Circuit

CIRCUIT DESCRIPTION

CAN TRANSCEIVER OPERATION

A CAN bus has two states called dominant and recessive. A dominant state is present on the bus when the differential voltage between CANH and CANL is greater than 0.9 V. A recessive state is present on the bus when the differential voltage between CANH and CANL is less than 0.5 V. During a dominant bus state, the CANH pin is high, and the CANL pin is low. During a recessive bus state, both the CANH and CANL pins are in the high impedance state.

Pin 18 (R_S) allows two different modes of operation to be selected: high-speed and slope control. For high-speed operation, the transmitter output transistors are simply switched on and off as fast as possible. In this mode, no measures are taken to limit the rise and fall slopes. A shielded cable is recommended to avoid electromagnetic interference (EMI) problems. High-speed mode is selected by connecting Pin 18 to ground.

Slope control mode allows the use of an unshielded twisted pair or a parallel pair of wires as bus lines. To reduce EMI, the rise and fall slopes must be limited. The rise and fall slopes can be programmed with a resistor connected from Pin 18 to ground. The slope is proportional to the current output at Pin 18.

SIGNAL ISOLATION

The ADM3053 signal isolation is implemented on the logic side of the interface. The part achieves signal isolation by having a digital isolation section and a transceiver section (see Figure 1). Data applied to the TxD pin referenced to logic ground (GND1) are coupled across an isolation barrier to appear at the transceiver section referenced to isolated ground (GND2). Similarly, the single-ended receiver output signal, referenced to isolated ground in the transceiver section, is coupled across the isolation barrier to appear at the RxD pin referenced to logic ground (GND1). The signal isolation is powered by the V_{IO} pin and allows the digital interface to 3.3 V or 5 V logic.

POWER ISOLATION

The ADM3053 power isolation is implemented using an *isoPower* integrated isolated dc-to-dc converter. The dc-to-dc converter section of the ADM3053 works on principles that are common to most modern power supplies. It is a secondary side controller architecture with isolated pulse-width modulation (PWM) feedback. V_{CC} power is supplied to an oscillating circuit that switches current into a chip-scale air core transformer. Power transferred to the secondary side is rectified and regulated to 5 V. The secondary (V_{ISO}) side controller regulates the output by creating a PWM control signal that is sent to the primary (V_{CC}) side by a dedicated *iCoupler* data channel. The PWM modulates the oscillator circuit to control the power being sent to the secondary side. Feedback allows for significantly higher power and efficiency.

The ADM3053 integrated dc-to-dc converter is designed as a self contained solution and must not drive an external load. To meet

additional isolated power needs, *isoPower* isolated dc-to-dc converters are available in a variety of power or power plus standard data channel options.

TRUTH TABLES

The truth tables in this section use the abbreviations found in Table 8.

Table 8. Truth Table Abbreviations

Letter	Description
H	High level
L	Low level
X	Don't care
Z	High impedance (off)
I	Indeterminate
NC	Not connected

Table 9. Transmitting

Supply Status		Input	Outputs		
V_{IO}	V_{CC}	TxD	Bus State	CANH	CANL
On	On	L	Dominant	H	L
On	On	H	Recessive	Z	Z
On	On	Floating	Recessive	Z	Z
Off	On	X	Recessive	Z	Z
On	Off	L	Indeterminate	I	I

Table 10. Receiving

Supply Status		Inputs	Output	
V_{IO}	V_{CC}	$V_{ID} = \text{CANH} - \text{CANL}$	Bus State	RxD
On	On	$\geq 0.9 \text{ V}$	Dominant	L
On	On	$\leq 0.5 \text{ V}$	Recessive	H
On	On	$0.5 \text{ V} < V_{ID} < 0.9 \text{ V}$	X ¹	I
On	On	Inputs open	Recessive	H
Off	On	X ¹	X ¹	I
On	Off	X ¹	X ¹	H

¹ X means don't care.

THERMAL SHUTDOWN

The ADM3053 contains thermal shutdown circuitry that protects the part from excessive power dissipation during fault conditions. Shorting the driver outputs to a low impedance source can result in high driver currents. The thermal sensing circuitry detects the increase in die temperature under this condition and disables the driver outputs. This circuitry is designed to disable the driver outputs when a die temperature of 150°C is reached. As the device cools, the drivers are reenabled at a temperature of 140°C.

CIRCUIT DESCRIPTION

DC CORRECTNESS AND MAGNETIC FIELD IMMUNITY

The digital signals transmit across the isolation barrier using iCoupler technology. This technique uses chip-scale transformer windings to couple the digital signals magnetically from one side of the barrier to the other.

Digital inputs are encoded into waveforms that are capable of exciting the primary transformer winding. At the secondary winding, the induced waveforms are decoded into the binary value that was originally transmitted.

Positive and negative logic transitions at the isolator input cause narrow (~1 ns) pulses to be sent to the decoder via the transformer. The decoder is bistable and is, therefore, either set or reset by the pulses, indicating input logic transitions. In the absence of logic transitions at the input for more than 1 μs, periodic sets of refresh pulses indicative of the correct input state are sent to ensure dc correctness at the output. If the decoder receives no internal pulses of more than approximately 5 μs, the input side is assumed to be unpowered or nonfunctional, in which case, the isolator output is forced to a default state by the watchdog timer circuit.

This situation must occur in the ADM3053 devices only during power-up and power-down operations. The limitation on the ADM3053 magnetic field immunity is set by the condition in which induced voltage in the transformer receiving coil is sufficiently large to either falsely set or reset the decoder. The following analysis defines the conditions under which this can occur.

The 3.3 V operating condition of the ADM3053 is examined because it represents the most susceptible mode of operation. The pulses at the transformer output have an amplitude of >1.0 V. The decoder has a sensing threshold of about 0.5 V, thus establishing a 0.5 V margin in which induced voltages can be tolerated. The voltage induced across the receiving coil is given by

$$V = (-d\beta / dt) \sum \pi r_n^2; n = 1, 2, \dots, N \tag{1}$$

where:

β is magnetic flux density (gauss).

N is the number of turns in the receiving coil.

r_n is the radius of the n^{th} turn in the receiving coil (cm).

Given the geometry of the receiving coil in the ADM3053 and an imposed requirement that the induced voltage be, at most, 50% of the 0.5 V margin at the decoder, a maximum allowable magnetic field is calculated as shown in Figure 26.

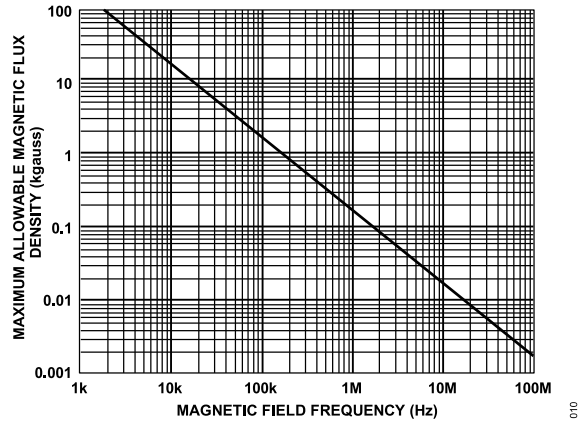

Figure 26. Maximum Allowable External Magnetic Flux Density

For example, at a magnetic field frequency of 1 MHz, the maximum allowable magnetic field of 0.2 kgauss induces a voltage of 0.25 V at the receiving coil. This is about 50% of the sensing threshold and does not cause a faulty output transition. Similarly, if such an event occurs during a transmitted pulse (and is of the worst-case polarity), it reduces the received pulse from >1.0 V to 0.75 V, which is still well above the 0.5 V sensing threshold of the decoder.

The preceding magnetic flux density values correspond to specific current magnitudes at given distances from the ADM3053 transformers. Figure 27 expresses these allowable current magnitudes as a function of frequency for selected distances. As shown in Figure 27, the ADM3053 is extremely immune and can be affected only by extremely large currents operated at high frequency very close to the component. For the 1 MHz example, a 0.5 kA current must be placed 5 mm away from the ADM3053 to affect component operation.

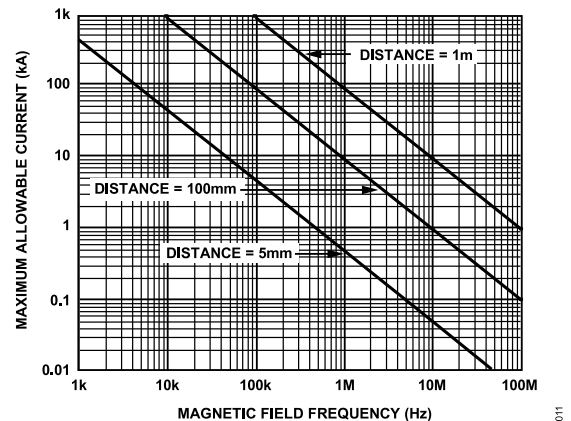

Figure 27. Maximum Allowable Current for Various Current-to-ADM3053 Spacings

Note that in combinations of strong magnetic field and high frequency, any loops formed by the printed circuit board (PCB) traces can induce error voltages sufficiently large to trigger the thresholds of succeeding circuitry. Proceed with caution in the layout of such traces to prevent this from occurring.

APPLICATIONS INFORMATION

PCB LAYOUT

The ADM3053 signal and power isolated CAN transceiver contains an *isoPower* integrated dc-to-dc converter, requiring no external interface circuitry for the logic interfaces. Power supply bypassing is required at the input and output supply pins (see [Figure 28](#)). The power supply section of the ADM3053 uses a 180 MHz oscillator frequency to pass power efficiently through its chip-scale transformers. In addition, the normal operation of the data section of the *iCoupler* introduces switching transients on the power supply pins.

Bypass capacitors are required for several operating frequencies. Noise suppression requires a low inductance, high frequency capacitor, whereas ripple suppression and proper regulation require a large value capacitor. These capacitors are connected between GND1 and Pin 6 (V_{IO}) for V_{IO} . It is recommended that a combination of 100 nF and 10 nF be placed as shown in [Figure 28](#) (C6 and C4). It is recommended that a combination of two capacitors, with values of 100 nF and 10 μ F, are placed between Pin 8 (V_{CC}) and Pin 9 (GND1) for V_{CC} as shown in [Figure 28](#) (C2 and C1). The V_{ISOIN} and V_{ISOOUT} capacitors are connected between Pin 11 (GND2) and Pin 12 (V_{ISOOUT}) with recommended values of 100 nF and 10 μ F as shown in [Figure 28](#) (C5 and C8). Two capacitors are recommended to be fitted Pin 19 (V_{ISOIN}) and Pin 20 (GND2) with values of 100nF and 10nF as shown in [Figure 28](#) (C9 and C7). The best practice recommended is to use a very low inductance ceramic capacitor, or its equivalent, for the smaller value. The total lead length between both ends of the capacitor and the input power supply pin must not exceed 10 mm.

The ADM3053 features an internal split paddle, lead frame on the bus side. For the best noise suppression, filter both the GND2 pins (Pin 11 and Pin13) and V_{ISOOUT} signals of the integrated dc-to-dc converter for high frequency currents. Use surface-mount ferrite beads in series with the signals before routing back to the device. See [Figure 28](#) for the recommended PCB layout.

The impedance of the ferrite bead is chosen to be about 2 k Ω between the 100 MHz and 1 GHz frequency range, to reduce the emissions at the 180 MHz primary switching frequency and the 360 MHz secondary side rectifying frequency and harmonics.

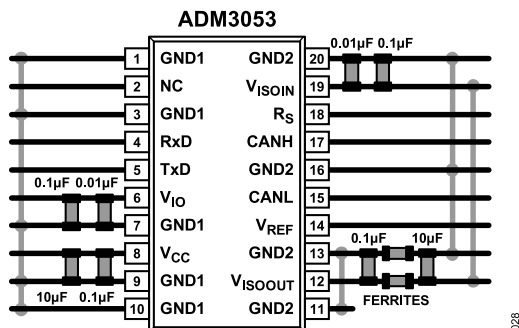

Figure 28. Recommended PCB Layout

In applications involving high common-mode transients, ensure that board coupling across the isolation barrier is minimized. Further-

more, design the board layout such that any coupling that does occur equally affects all pins on a given component side.

Failure to ensure this can cause voltage differentials between pins exceeding the absolute maximum ratings for the device, thereby leading to latch-up and/or permanent damage.

The ADM3053 dissipates approximately 650 mW of power when fully loaded. Because it is not possible to apply a heat sink to an isolation device, the devices primarily depend on heat dissipation into the PCB through the GND pins. If the devices are used at high ambient temperatures, provide a thermal path from the GND pins to the PCB ground plane. The board layout in [Figure 28](#) shows enlarged pads for Pin 1, Pin 3, Pin 9, Pin 10, Pin 11, Pin 14, Pin 16, and Pin 20. Implement multiple vias from the pad to the ground plane to reduce the temperature inside the chip significantly. The dimensions of the expanded pads are at the discretion of the designer and dependent on the available board space.

EMI CONSIDERATIONS

The dc-to-dc converter section of the ADM3053 must, of necessity, operate at very high frequency to allow efficient power transfer through the small transformers. This creates high frequency currents that can propagate in circuit board ground and power planes, causing edge and dipole radiation. Grounded enclosures are recommended for applications that use these devices. If grounded enclosures are not possible, good RF design practices must be followed in the layout of the PCB. See the [AN-0971 Application Note, Recommendations for Control of Radiated Emissions with *isoPower* Devices](#), for more information.

 R_S PIN

For high speed mode, the R_S pin is connected directly to GND2 (Pin 16 or Pin 20). The transition time of the CAN bus signals are short as possible, allowing higher speed signaling. A shielded cable is recommended to avoid EMI problems in high speed mode.

Slope control mode allows the use of unshielded twisted pair wires or parallel pair wires as bus lines. The signal rise and fall transition times are slowed to reduce EMI and ringing. The rise and fall slopes are adjusted with the resistor (R_{SLOPE}) connected from R_S to GND2. See [Figure 6](#) for details.

The R_S pin cannot be left floating.

APPLICATIONS INFORMATION

INSULATION LIFETIME

All insulation structures eventually break down when subjected to voltage stress over a sufficiently long period. The rate of insulation degradation is dependent on the characteristics of the voltage waveform applied across the insulation. Analog Devices conducts an extensive set of evaluations to determine the lifetime of the insulation structure within the ADM3053.

Accelerated life testing is performed using voltage levels higher than the rated continuous working voltage. Acceleration factors for several operating conditions are determined, allowing calculation of the time to failure at the working voltage of interest. The values shown in [Table 5](#) summarize the peak voltages for 50 years of service life in several operating conditions. In many cases, the working voltage approved by agency testing is higher than the 50 year service life voltage. Operation at working voltages higher than the service life voltage listed leads to premature insulation failure.

The insulation lifetime of the ADM3053 depends on the voltage waveform type imposed across the isolation barrier. The *iCoupler* insulation structure degrades at different rates, depending on whether the waveform is bipolar ac, unipolar ac, or dc. [Figure 29](#), [Figure 30](#), and [Figure 31](#) illustrate these different isolation voltage waveforms.

Bipolar ac voltage is the most stringent environment. A 50 year operating lifetime under the bipolar ac condition determines the Analog Devices recommended maximum working voltage.

In the case of unipolar ac or dc voltage, the stress on the insulation is significantly lower. This allows operation at higher working

voltages while still achieving a 50 year service life. The working voltages listed in [Table 5](#) can be applied while maintaining the 50 year minimum lifetime, provided the voltage conforms to either the unipolar ac or dc voltage cases. Any cross insulation voltage waveform that does not conform to [Figure 30](#) or [Figure 31](#) must be treated as a bipolar ac waveform, and its peak voltage must be limited to the 50-year lifetime voltage value listed in [Table 5](#).

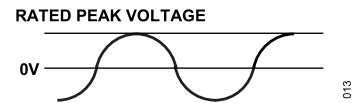

Figure 29. Bipolar AC Waveform

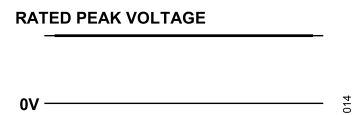
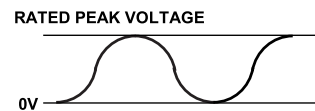

Figure 30. DC Waveform



NOTES

1. THE VOLTAGE IS SHOWN AS SINUSOIDAL FOR ILLUSTRATION PURPOSES ONLY. IT IS MEANT TO REPRESENT ANY VOLTAGE WAVEFORM VARYING BETWEEN 0 AND SOME LIMITING VALUE. THE LIMITING VALUE CAN BE POSITIVE OR NEGATIVE, BUT THE VOLTAGE CANNOT CROSS 0V.

Figure 31. Unipolar AC Waveform

TYPICAL APPLICATIONS

Figure 32 is an example circuit diagram using the ADM3053.

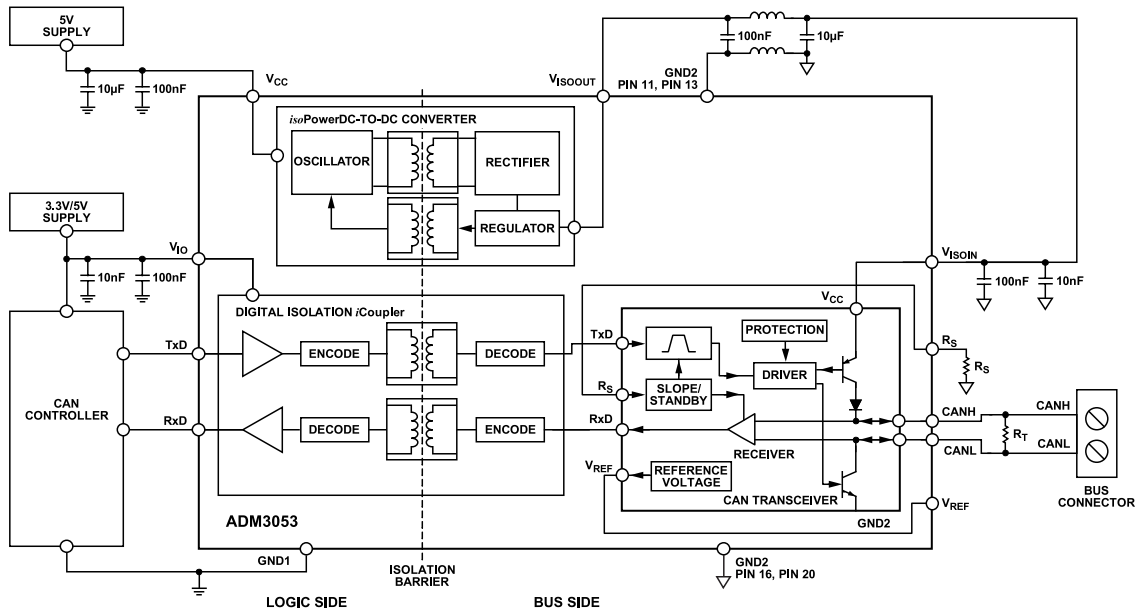

Figure 32. Example Circuit Diagram Using the ADM3053

OUTLINE DIMENSIONS

Package Drawing (Option)	Package Type	Package Description
RW-20	SOIC_W	20-Lead Standard Small Outline Package

For the latest package outline information and land patterns (footprints), go to [Package Index](#).

ORDERING GUIDE

Model ¹	Temperature Range	Package Description	Packing Quantity	Package Option
ADM3053BRWZ	-40°C to +85°C	20-Lead Standard Small Outline Package [SOIC_W]	Tube, 37	RW-20
ADM3053BRWZ-REEL7	-40°C to +85°C	20-Lead Standard Small Outline Package [SOIC_W]	Reel, 400	RW-20

¹ Z = RoHS Compliant Part.

EVALUATION BOARDS

Model ¹	Description
EVAL-ADM3053EBZ	Evaluation Board
ADZS-CM403F-EZLITE	Evaluation Board
EVAL-2LCANRS485EBZ	Evaluation Board
EZLINX-IIIDE-EBZ	iCoupler Isolated Interface Development Environment Evaluation Board

¹ Z = RoHS Compliant Part.