

### FEATURES

- 4-wire touch screen interface
- LCD noise reduction feature (STOPACQ pin)
- Automatic conversion sequencer and timer
- User-programmable conversion parameters
- On-chip temperature sensor:  $-40^{\circ}\text{C}$  to  $+85^{\circ}\text{C}$
- On-chip 2.5 V reference
- On-chip 8-bit DAC
- 3 auxiliary analog inputs
- 1 dedicated and 3 optional GPIOs
- 2 direct battery measurement channels (0.5 V to 5 V)
- 3 interrupt outputs
- Touch-pressure measurement
- Wake up on touch function
- Specified throughput rate of 125 kSPS
- Single supply,  $V_{\text{CC}}$  of 2.7 V to 5.25 V
- Separate  $V_{\text{DRIVE}}$  level for serial interface
- Shutdown mode: 1  $\mu\text{A}$  maximum
- 32-lead, LFCSP, 5 mm  $\times$  5 mm package
- 25-ball, WLCSP, 2.5 mm  $\times$  2.8 mm package

### APPLICATIONS

- Personal digital assistants
- Smart hand-held devices
- Touch screen monitors
- Point-of-sale terminals
- Medical devices
- Cell phones
- Pagers

### GENERAL DESCRIPTION

The AD7877 is a 12-bit, successive approximation ADC with a synchronous serial interface and low on resistance switches for driving touch screens. The AD7877 operates from a single 2.7 V to 5.25 V power supply (functional operation to 2.2 V), and features throughput rates of 125 kSPS. The AD7877 features direct battery measurement on two inputs, temperature and touch-pressure measurement.

The AD7877 also has an on-board reference of 2.5 V. When not in use, it can be shut down to conserve power. An external reference can also be applied and varied from 1 V to  $+V_{\text{CC}}$ , with an analog input range of 0 V to  $V_{\text{REF}}$ . The device includes a shutdown mode that reduces its current consumption to less than 1  $\mu\text{A}$ .

Rev. C

Information furnished by Analog Devices is believed to be accurate and reliable. However, no responsibility is assumed by Analog Devices for its use, nor for any infringements of patents or other rights of third parties that may result from its use. Specifications subject to change without notice. No license is granted by implication or otherwise under any patent or patent rights of Analog Devices. Trademarks and registered trademarks are the property of their respective owners.

### FUNCTIONAL BLOCK DIAGRAM

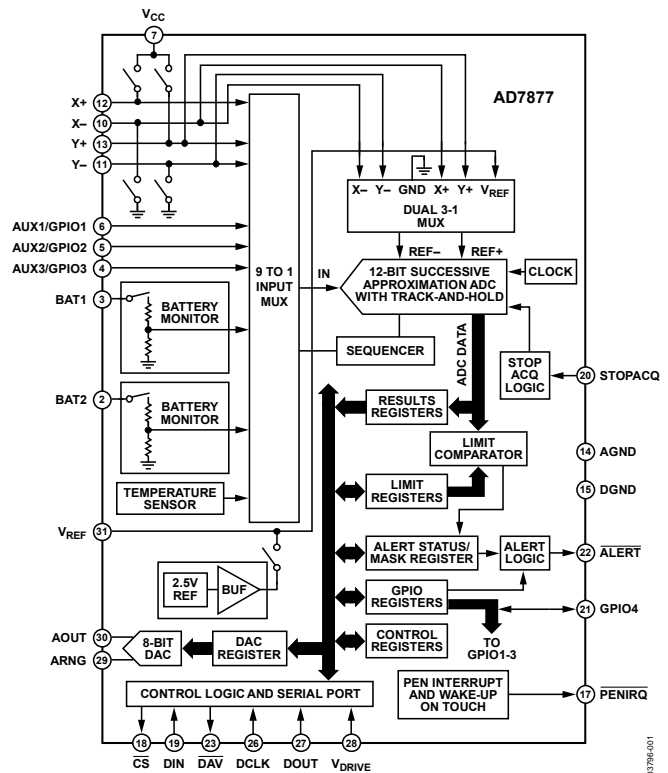

Figure 1.

To reduce the effects of noise from LCDs, the acquisition phase of the on-board ADC is controlled via the STOPACQ pin. User-programmable conversion controls include variable acquisition time and first conversion delay. Up to 16 averages can be taken per conversion. There is also an on-board DAC for LCD backlight or contrast control. The AD7877 runs in either slave or master mode using a conversion sequencer and timer. It is ideal for battery-powered systems such as personal digital assistants with resistive touch screens and other portable equipment.

The part is available in a 32-lead lead frame chip scale package (LFCSP), and a 25-ball wafer level chip scale package (WLCSP).











## PIN CONFIGURATIONS AND FUNCTION DESCRIPTIONS

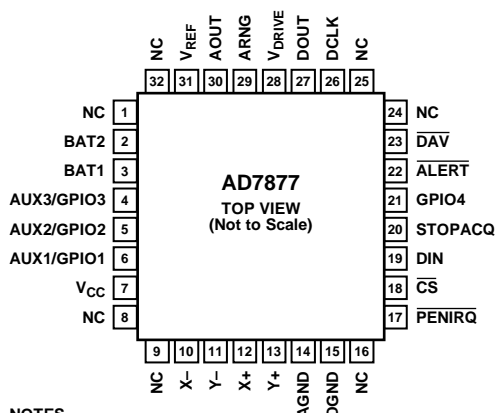

## NOTES

1. NC = NO CONNECT
2. THE EXPOSED PAD IS NOT CONNECTED INTERNALLY. FOR INCREASED RELIABILITY OF THE SOLDER JOINTS AND MAXIMUM THERMAL CAPABILITY, IT IS RECOMMENDED THAT THE PAD BE SOLDERED TO GROUND PLANE.

Figure 4. LFCSP Pin Configuration

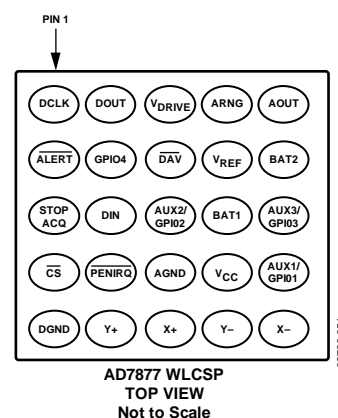

Figure 5. WLCSP Pin Configuration

Table 4. Pin Function Descriptions

Pin No.	Mnemonic	Description
1, 8, 9, 16, 24, 25, 32	NC	No Connect.
2	BAT2	Battery Monitor Input. ADC Input Channel 7.
3	BAT1	Battery Monitor Input. ADC Input Channel 6.
4	AUX3/GPIO3	Auxiliary Analog Input. ADC Input Channel 5. Can be reconfigured as GPIO pin.
5	AUX2/GPIO2	Auxiliary Analog Input. ADC Input Channel 4. Can be reconfigured as GPIO pin.
6	AUX1/GPIO1	Auxiliary Analog Input. ADC Input Channel 3. Can be reconfigured as GPIO pin.
7	V <sub>CC</sub>	Power Supply Input. The V <sub>CC</sub> range for the AD7877 is from 2.2 V to 5.25 V.
10	X-	Touch Screen Position Input.
11	Y-	Touch Screen Position Input. ADC Input Channel 2.
12	X+	Touch Screen Position Input. ADC Input Channel 0.
13	Y+	Touch Screen Position Input. ADC Input Channel 1.
14	AGND	Analog Ground. Ground reference point for all analog circuitry on the AD7877. All analog input signals and any external reference signal should be referred to this voltage.
15	DGND	Digital Ground. Ground reference for all digital circuitry on the AD7877. Refer all digital input signals to this voltage.
17	PENIRQ	Pen Interrupt. Digital active low output (has a 50 k $\Omega$ internal pull-up resistor).
18	$\overline{CS}$	Chip Select Input. Active low logic input. This input provides the dual function of initiating conversions on the AD7877 and enabling the serial input/output register.
19	DIN	SPI <sup>®</sup> Serial Data Input. Data to be written to the AD7877 registers are provided on this input and clocked into the register on the rising edge of DCLK.
20	STOPACQ	Stop Acquisition Pin. A signal applied to this pin can be monitored by the AD7877, so that acquisition of new data by the ADC is halted while the signal is active. Used to reduce the effect of noise from an LCD screen on the touch screen measurements.
21	GPIO4	Dedicated General-Purpose Logic Input/Output Pin.
22	$\overline{ALERT}$	Digital Active Low Output. Interrupt output that goes low if a GPIO data bit is set, or if the AUX1, TEMP1, BAT1, or BAT2 measurements are out of range.
23	$\overline{DAV}$	Data Available Output. Active low logic output. Asserts low when new data is available in the AD7877 results registers.
26	DCLK	External Clock Input. Logic input. DCLK provides the serial clock for accessing data from the part.
27	DOUT	Serial Data Output. Logic output. The conversion result from the AD7877 is provided on this output as a serial data stream. The bits are clocked out on the falling edge of the DCLK input. This output is high impedance when $\overline{CS}$ is high.



# TYPICAL PERFORMANCE CHARACTERISTICS

$T_A = 25^\circ\text{C}$ ,  $V_{CC} = 2.7\text{ V}$ ,  $V_{REF} = 2.5\text{ V}$ ,  $f_{SAMPLE} = 125\text{ kHz}$ ,  $f_{DCLK} = 16 \times f_{SAMPLE} = 2\text{ MHz}$ , unless otherwise noted.

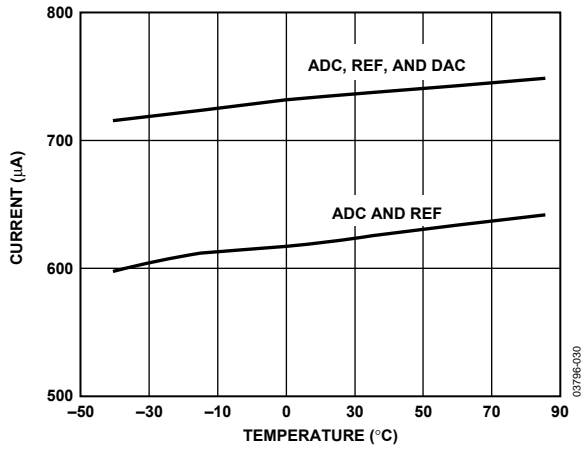

Figure 6. Supply Current vs. Temperature

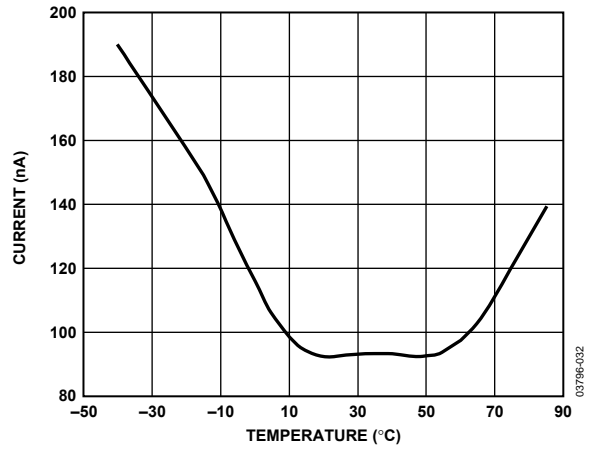

Figure 9. Full Power-Down  $I_{DD}$  vs. Temperature

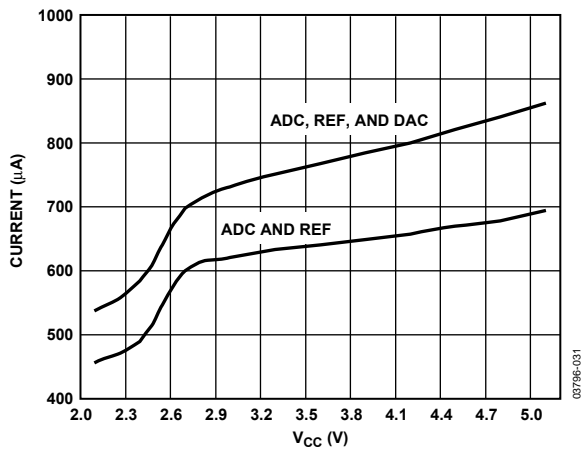

Figure 7. Supply Current vs.  $V_{CC}$

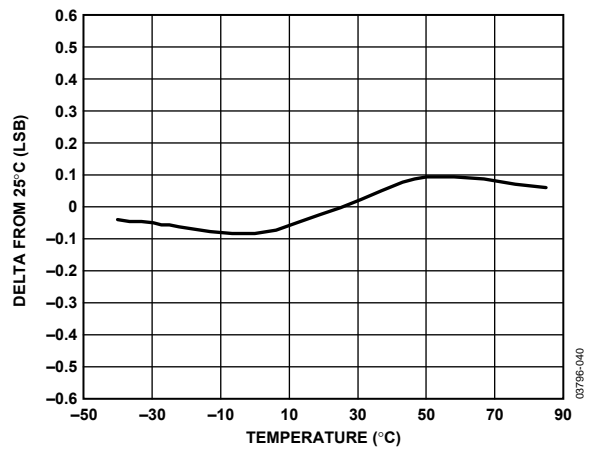

Figure 10. Change in ADC Offset vs. Temperature

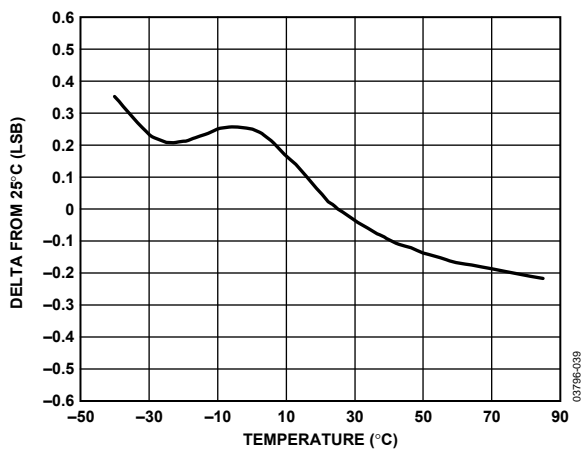

Figure 8. Change in ADC Gain vs. Temperature

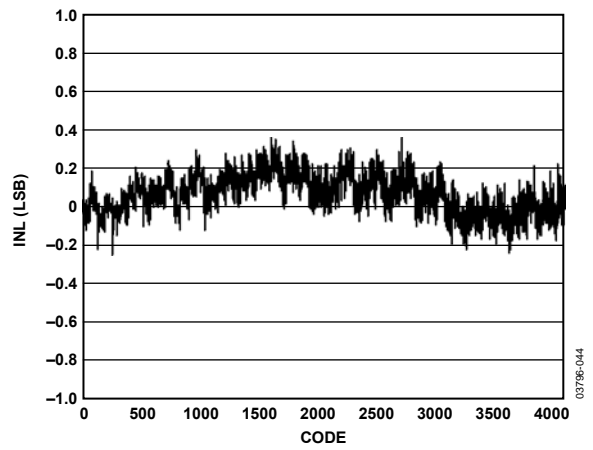

Figure 11. ACD INL Plot

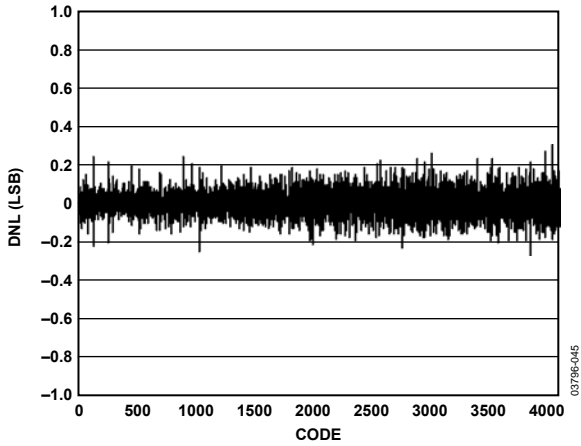

Figure 12. ADC DNL Plot

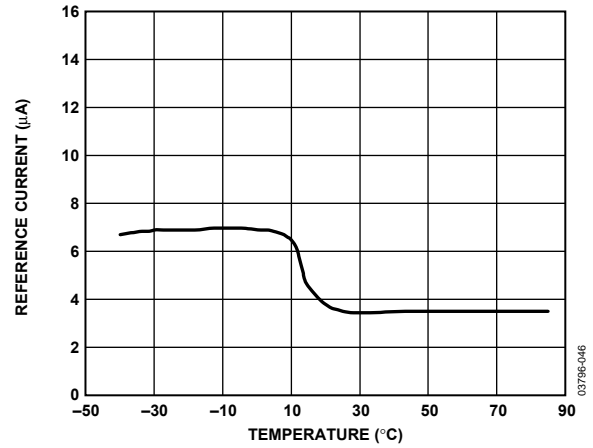

Figure 15. External Reference Current vs. Temperature

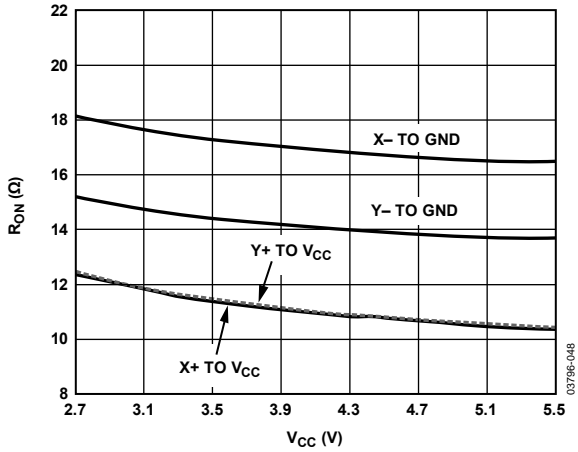

Figure 13. Switch On Resistance vs.  $V_{CC}$   
(X+, Y+:  $V_{CC}$  to Pin; X-, Y-: Pin to GND)

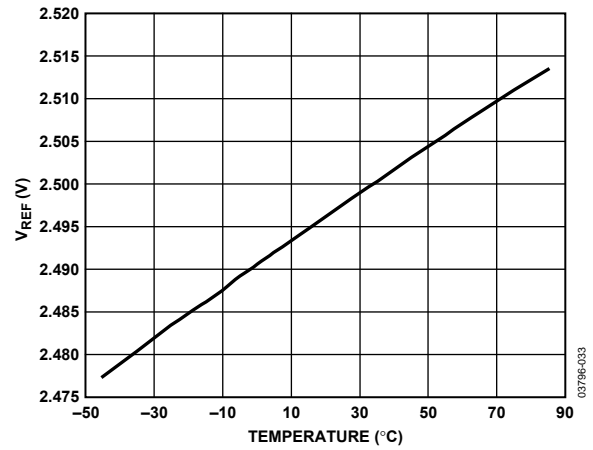

Figure 16. Internal  $V_{REF}$  vs. Temperature

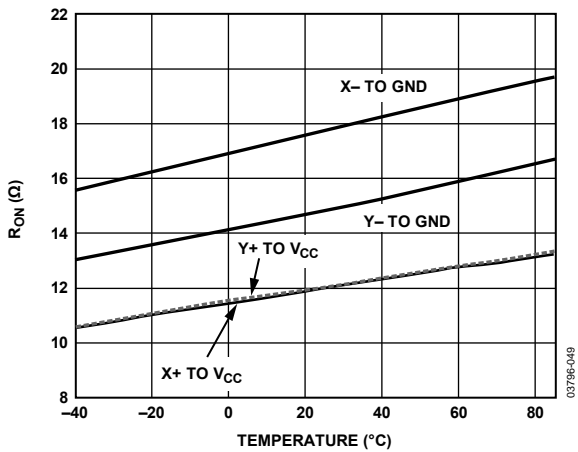

Figure 14. Switch On Resistance vs. Temperature  
(X+, Y+:  $V_{CC}$  to Pin; X-, Y-: Pin to GND)

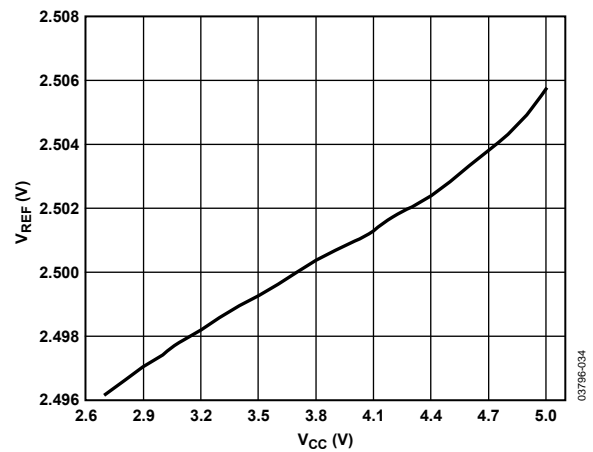

Figure 17. Internal  $V_{REF}$  vs.  $V_{CC}$

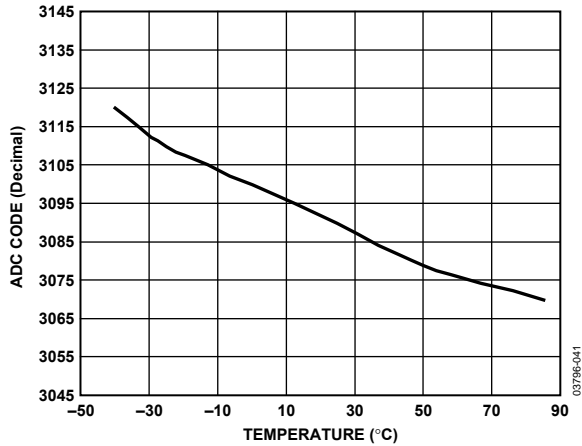

Figure 18. ADC Code vs. Temperature (2.7 V Supply)

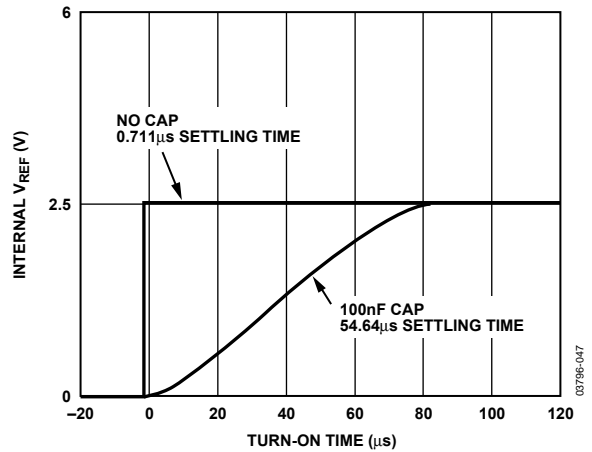

Figure 21. Internal  $V_{REF}$  vs. Turn-On Time

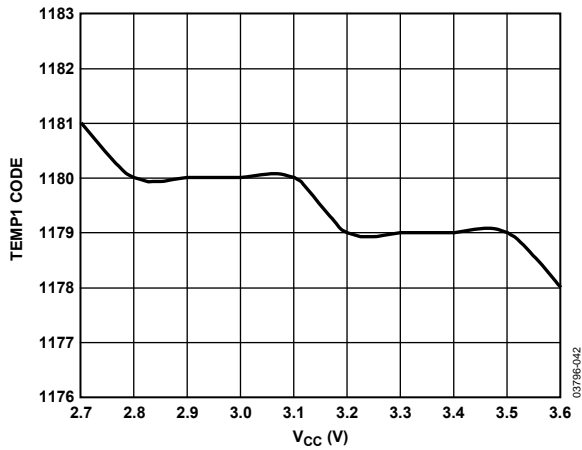

Figure 19. Temp1 vs.  $V_{CC}$

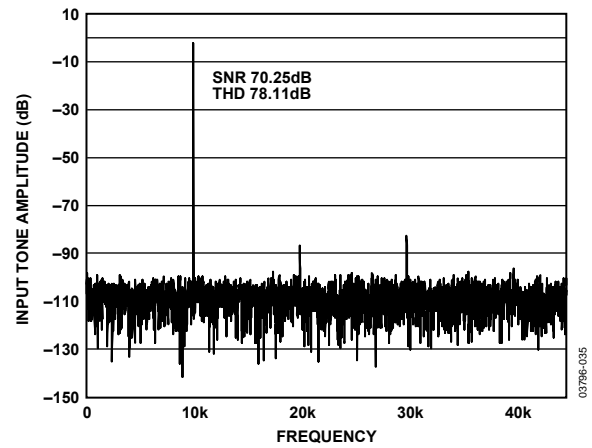

Figure 22. Typical FFT Plot for the Auxiliary Channels of the AD7877 at 90 kHz Sample Rate and 10 kHz Input Frequency

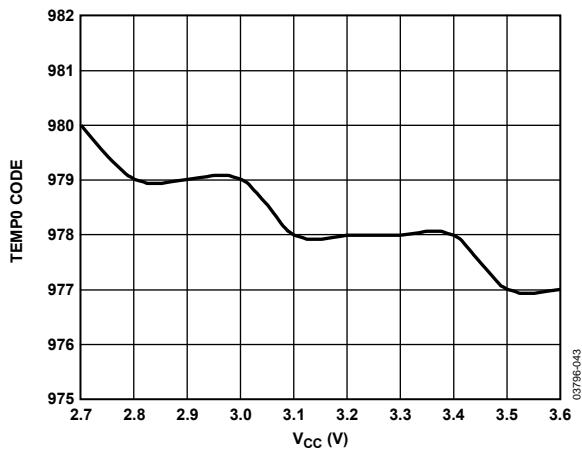

Figure 20. Temp0 vs.  $V_{CC}$

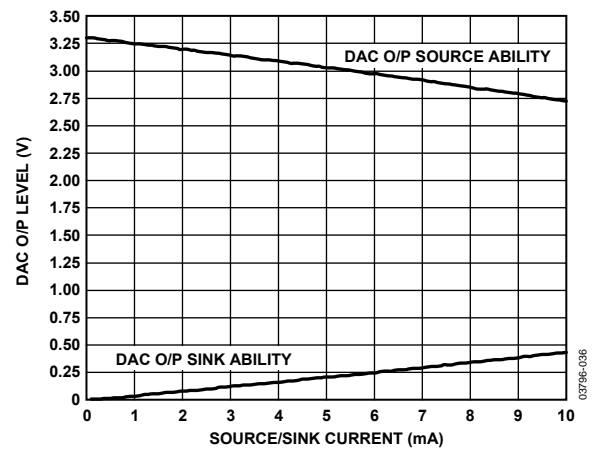

Figure 23. DAC Source and Sink Current Capability

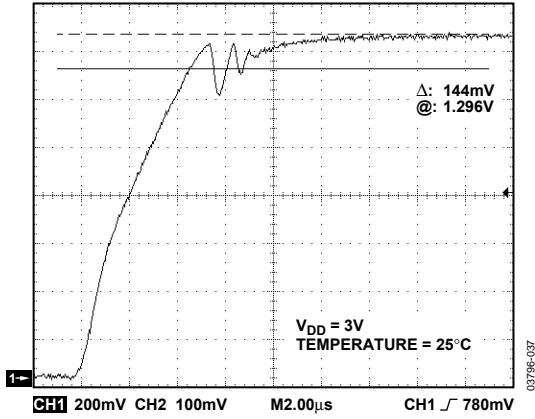

Figure 24. DAC Output Settling Time (Zero Scale to Half Scale)

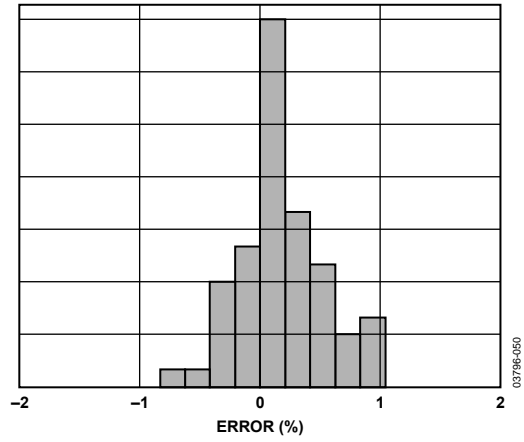

Figure 26. Typical Accuracy for Battery Channel (25°C)

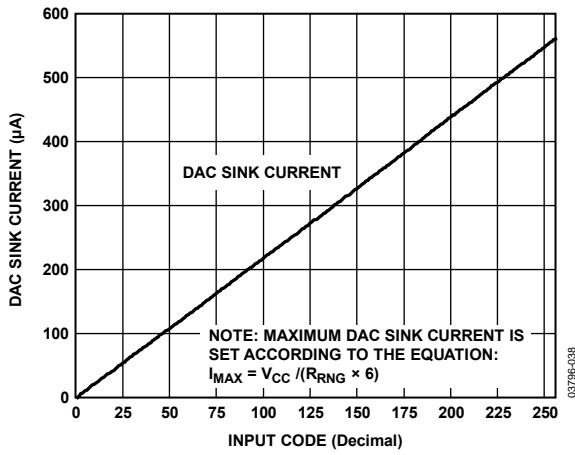

Figure 25. DAC Sink Current vs. Input Code with  $R_{RING} = 1k$

## TERMINOLOGY

### **Integral Nonlinearity (INL)**

The maximum deviation from a straight line passing through the endpoints of the ADC transfer function. The endpoints of the transfer function are zero scale at 1 LSB below the first code transition, and full scale at 1 LSB above the last code transition.

### **Differential Nonlinearity (DNL)**

The difference between the measured and the ideal 1 LSB change between any two adjacent codes in the ADC.

### **Offset Error**

The deviation of the first code transition (00...000) to (00...001) from the ideal ( $AGND + 1 \text{ LSB}$ ).

### **Gain Error**

The deviation of the last code transition (111...110) to (111...111) from the ideal ( $V_{REF} - 1 \text{ LSB}$ ) after the offset error has been adjusted out.

### **On Resistance**

A measure of the ohmic resistance between the drain and the source of the switch drivers.

## CIRCUIT INFORMATION

The AD7877 is a complete, 12-bit data acquisition system for digitizing positional inputs from a touch screen in PDAs and other devices. In addition, it can monitor two battery voltages, ambient temperature, and three auxiliary analog voltages, with high and low limit comparisons on three of the inputs, and has up to four general-purpose logic I/O pins.

The core of the AD7877 is a high speed, low power, 12-bit analog-to-digital converter (ADC) with input multiplexer, on-chip track-and-hold, and on-chip clock. The results of conversions are stored in 11 results registers, and the results from one auxiliary input and two battery inputs can be compared with high and low limits stored in limit registers to generate an out-of-limit ALERT. The AD7877 also contains low resistance analog switches to switch the X and Y excitation voltages to the touch screen, a STOPACQ pin to control the ADC acquisition period, 2.5 V reference, on-chip temperature sensor, and 8-bit DAC to control LCD contrast. The high speed SPI serial bus provides control of, and communication with, the device.

Operating from a single supply from 2.2 V to 5 V, the AD7877 offers throughput rates of up to 125 kHz. The device is available in a 5 mm × 5 mm, 32-lead, lead frame chip scale package (LFCSP), and in a 2.5 mm × 2.8 mm, wafer level chip scale package (WLCSP), with a 5 × 5 ball grid array.

The data acquisition system of the AD7877 has a number of advanced features:

- Input channel sequenced automatically or selected by the host.
- STOPACQ feature to reduce noise from LCD.
- Averaging of from 1 to 16 conversions for noise reduction.
- Programmable acquisition time.
- Power management.
- Programmable ADC power-up delay before first conversion.
- Choice of internal or external reference.
- Conversion at preprogrammed intervals.

### TOUCH SCREEN PRINCIPLES

A 4-wire touch screen consists of two flexible, transparent, resistive-coated layers that are normally separated by a small air gap. The X layer has conductive electrodes running down the left and right edges, allowing the application of an excitation voltage across the X layer from left to right.

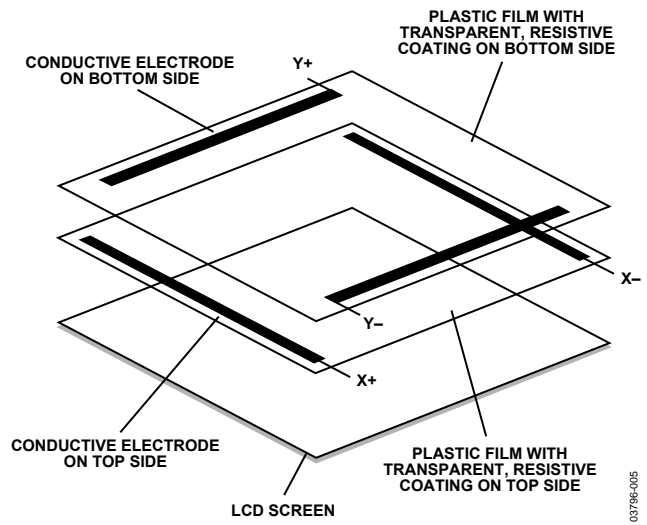

Figure 27. Basic Construction of a Touch Screen

The Y layer has conductive electrodes running along the top and bottom edges, allowing the application of an excitation voltage down the Y layer from top to bottom.

Provided that the layers are of uniform resistivity, the voltage at any point between the two electrodes is proportional to the horizontal position for the X layer and the vertical position for the Y layer.

When the screen is touched, the two layers make contact. If only the X layer is excited, the voltage at the point of contact, and therefore the horizontal position, can be sensed at one of the Y layer electrodes. Similarly, if only the Y layer is excited, the voltage, and therefore the vertical position, can be sensed at one of the X layer electrodes. By switching alternately between X and Y excitation and measuring the voltages, the X and Y coordinates of the contact point can be found.

In addition to measuring the X and Y coordinates, it is also possible to estimate the touch pressure by measuring the contact resistance between the X and Y layers. The AD7877 is designed to facilitate this measurement.

Figure 28 shows an equivalent circuit of the analog input structure of the AD7877, showing the touch screen switches, the main analog multiplexer, the ADC with analog and differential reference inputs, and the dual 3-to-1 multiplexer that selects the reference source for the ADC.



For greater accuracy, the ratiometric method has two significant advantages:

- The reference to the ADC is provided from the actual voltage across the screen; therefore, when the voltage drops across the switches, it has no effect.
- Because the measurement is ratiometric, it does not matter if the voltage across the screen varies in the long term. However, it must not change after the signal has been acquired.

The disadvantage of the ratiometric method is that the screen must be powered up at all times because it provides the reference voltage for the ADC.

## TOUCH-PRESSURE MEASUREMENT

The pressure applied to the touch screen via a pen or finger can also be measured with the AD7877 using some simple calculations. The contact resistance between the X and Y plates is measured providing a good indication of the size of the depressed area and, therefore, the applied pressure. The area of the spot that is touched is proportional to the size of the object touching it. The size of this resistance ( $R_{TOUCH}$ ) can be calculated using two different methods.

### First Method

The first method requires the user to know the total resistance of the X-plate tablet ( $R_X$ ). Three touch screen conversions are required:

- Measurement of the X position,  $X_{POSITION}$  ( $Y+$  input).
- Measurement of the  $Y-$  input with the excitation voltage applied to  $Y+$  and  $X-$  ( $Z1$  measurement).
- Measurement of the  $X+$  input with the excitation voltage applied to  $Y+$  and  $X-$  ( $Z2$  measurement).

These three measurements are illustrated in Figure 31.

The AD7877 has two special ADC channel settings that configure the X and Y switches for  $Z1$  and  $Z2$  measurement and store the results in the  $Z1$  and  $Z2$  results registers. The  $Z1$  measurement is ADC Channel 1010b, and the result is stored in the register with Read Address 11010b. The  $Z2$  measurement is ADC Channel 0010b, and the result is stored in the register with Read Address 10010b.

The touch resistance can then be calculated using the following equation:

$$R_{TOUCH} = (R_{XPlate}) \times (X_{POSITION}/4096 \times [Z2/Z1] - 1) \quad (2)$$

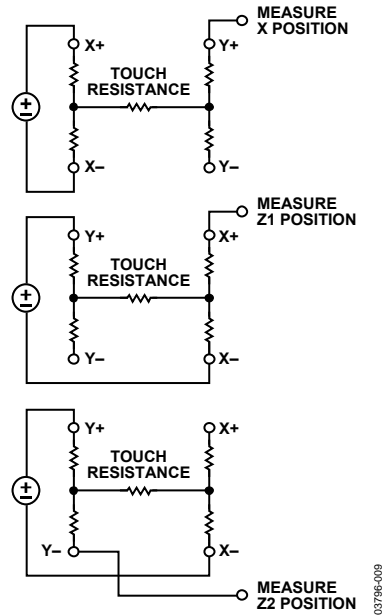

Figure 31. Three Measurements Required for Touch Pressure

### Second Method

The second method requires the user to know the resistance of the X-plate and Y-plate tablets. Three touch screen conversions are required, a measurement of the X position ( $X_{POSITION}$ ), Y position ( $Y_{POSITION}$ ), and  $Z1$  position.

The following equation also calculates the touch resistance:

$$R_{TOUCH} = R_{XPlate} \times (X_{POSITION}/4096) \times [(4096/Z1) - 1] - R_{YPlate} \times [1 - (Y_{POSITION}/4096)] \quad (3)$$

### STOPACQ PIN

As previously explained in the Touch Screen Principles section, touch screens are composed of two resistive layers, normally placed over an LCD screen. Because these layers are in close proximity to the LCD screen, noise can be coupled from the screen onto these resistive layers, causing errors in the touch screen positional measurements.

For example, a jitter might be noticeable in the cursor on-screen. In most LCD touch screen systems, a signal, such as an LCD invert signal or other control signal, is present, and noise is usually coupled onto the touch screen during the active period of this signal (see Figure 32).

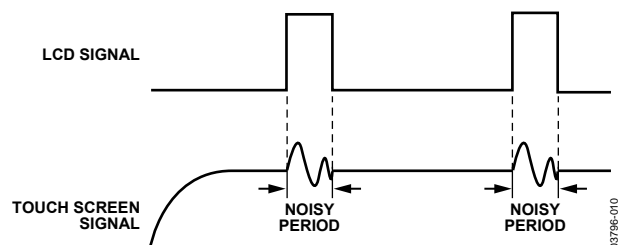

Figure 32. Effect of LCD Noise on Touch Screen Measurements

It is only during the sample or acquisition phase of the ADC operation of the AD7877 that noise from the LCD screen has an effect on the ADC measurements. During the hold or conversion phase, the noise has no effect, because the voltage at the input of the ADC has already been acquired. Therefore, to minimize the effect of noise on the touch screen measurements, the ADC acquisition phase should be halted.

The LCD control signal should be applied to the STOPACQ pin. To ensure that acquisition never occurs during the noisy period when the LCD signal is active, the AD7877 monitors this signal. No acquisitions take place when the control signal is active. Any acquisition that is in progress when the signal becomes active is aborted and restarts when the signal becomes inactive again.

To accommodate signals of different polarities on the STOPACQ pin, a user-programmable register bit is used to indicate whether the signal is active high or low. The POL bit is Bit 3 in Control Register 2, Address 0x02. Setting POL to 1 indicates that the signal on STOPACQ is active high; setting POL to 0 indicates that it is active low. POL defaults to 0 on power-up. To disable monitoring of STOPACQ, the pin should be tied low if POL = 1, or tied high if POL = 0. Under no circumstances should the pin be left floating.

The signal on STOPACQ has no effect while the ADC is in conversion mode, or during the first conversion delay time. (See the Control Registers section for details on the first conversion delay.)

When enabled, the STOPACQ monitoring function is implemented on all input channels to the ADC: AUX1, AUX2, BAT1, BAT2, TEMP1, and TEMP2, as well as on the touch screen input channels.

## TEMPERATURE MEASUREMENT

Two temperature measurement options are available on the AD7877: the single conversion method and the differential conversion method. The single conversion method requires only a single measurement on ADC Channel 1000b. Whereas differential conversion requires two measurements, one on ADC Channel 1000b and a second on ADC Channel 1001b. The results are stored in the results registers with Address 11000b (TEMP1) and Address 11001b (TEMP2). The AD7877 does not provide an explicit output of the temperature reading; the system must perform some external calculations. Both methods are based on an on-chip diode measurement.

### Single Conversion Method

The single conversion method makes use of the fact that the temperature coefficient of a silicon diode is approximately  $-2.1 \text{ mV}/^\circ\text{C}$ . However, this small change is superimposed on the diode forward voltage, which can have a wide tolerance. It is, therefore, necessary to calibrate by measuring the diode voltage at a known temperature to provide a baseline from which the change in forward voltage with temperature can be

measured. This method provides a resolution of approximately  $0.3^\circ\text{C}$  and a predicted accuracy of  $\pm 2.5^\circ\text{C}$ .

The temperature limit comparison is performed on the result in the TEMP1 results register, which is simply the measurement of the diode forward voltage. The values programmed into the high and low limits should be referenced to the calibrated diode forward voltage to make accurate limit comparisons. An example is shown in the Limit Comparison section.

### Differential Conversion Method

The differential conversion method is a 2-point measurement. The first measurement is performed with a fixed bias current into a diode (when the TEMP1 channel is selected), and the second measurement is performed with a fixed multiple of the bias current into the same diode (when the TEMP2 channel is selected). The voltage difference in the diode readings is proportional to absolute temperature and is given by the following formula:

$$V_{BE} = (kT/q) \times (\ln N) \quad (4)$$

where:

$V_{BE}$  represents the diode voltage.

$N$  is the bias current multiple (typical value for AD7877 = 120).

$k$  is Boltzmann's constant.

$q$  is the electron charge.

This method provides a resolution of approximately  $1.6^\circ\text{C}$ , and a guaranteed accuracy of  $\pm 4^\circ\text{C}$  without calibration. Determination of the  $N$  value on a part-by-part basis improves accuracy.

Assuming a current multiple of 120, which is a typical value for the AD7877, taking Boltzmann's constant,  $k = 1.38054 \times 10^{-23}$  electrons  $\text{V}/^\circ\text{K}$ , the electron charge  $q = 1.602189 \times 10^{-19}$ , then  $T$ , the ambient temperature in Kelvin, would be calculated as follows:

$$\begin{aligned} V_{BE} &= (kT/q) \times (\ln N) \\ T^\circ\text{K} &= (V_{BE} \times q) / (k \times \ln N) \\ &= (V_{BE} \times 1.602189 \times 10^{-19}) / (1.38054 \times 10^{-23} \times 4.65) \\ T^\circ\text{C} &= 2.49 \times 120 \times V_{BE} - 273 \end{aligned}$$

$V_{BE}$  is calculated from the difference in readings from the first conversion to the second conversion. The user must perform the calculations to get  $V_{BE}$ , and then calculate the temperature value in degrees. Figure 33 shows a block diagram of the temperature measurement circuit.

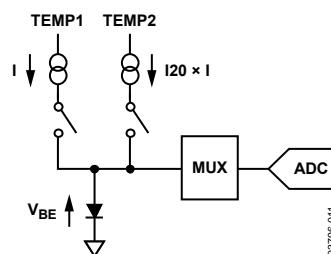

Figure 33. Block Diagram of Temperature Measurement Circuit



## AUXILIARY INPUTS

The AD7877 has three auxiliary analog inputs, AUX1 to AUX3. These channels have a full-scale input range from 0 V to  $V_{REF}$ . The ADC channel addresses for AUX1 to AUX3 are 0011b, 0100b, and 0101b, and the results are stored in Register 10011b, Register 10100b, and Register 10101b. These pins can also be reconfigured as general-purpose logic inputs/outputs, as described in the GPIO Configuration section.

## LIMIT COMPARISON

The AUX1 measurement, the two battery measurements, and the TEMP1 measurement can all be compared with high and low limits, and an out-of-limit result that generates an alarm output at the  $\overline{ALERT}$  pin. The limits are stored in registers with addresses from 00100b to 01011b. After a measurement from any one of the four channels is converted, it is compared with the corresponding high and low limits. An out-of-limit result sets one of the status bits in the alert status/enable register. For details on these and other registers, see the Register Maps and Detailed Register Descriptions sections. For details on writing and reading data, see the Serial Interface section.

As described in the Single Conversion Method section, the temperature comparison is made using the result of the TEMP1 measurement, that is, the diode forward voltage. Because the temperature coefficient of the diode is known but the actual forward voltage can have a wide tolerance, it is not possible to program the high and low limit registers with predetermined values.

Instead, it is necessary to calibrate the temperature measurement, calculate the TEMP1 readings at the high and low limit temperatures, and then program those values into the limit registers, as follows:

1. Calculate  

$$LSB \text{ per degree} = -2.1 \text{ mV} / (V_{REF} / 4096).$$
2. Save the calibration reading  $D_{CAL}$  at the calibration temperature,  $T_{CAL}$ .
3. Subtract  $T_{CAL}$  from limit temperatures  $T_{HIGH}$  and  $T_{LOW}$  to get the difference in degrees between the limit temperatures and the calibration temperature.
4. Multiply this value by LSB per degree to obtain the value in LSBs.
5. Add these values to the digital value at the calibration temperature to get the digital high and low limit values.

Example:

The internal 2.5 V reference is used.

1.  $T_{HIGH} = +65^{\circ}\text{C}$  and  $T_{LOW} = -10^{\circ}\text{C}$ .
2.  $LSB \text{ per degree} = -2.1 \times 10^{-3} / (2.5 / 4096) = -3.44.$
3.  $D_{CAL} = 983$  decimal at  $25^{\circ}\text{C}$ .
4.  $D_{HIGH} = (65 - 25) \times -3.44 + 983 = 845.$
5.  $D_{LOW} = (-10 - 25) \times -3.44 + 983 = 1103.$

## CONTROL REGISTERS

Control Register 1 contains the ADC channel address, the  $\overline{\text{SER/DFR}}$  bit (to choose single or differential methods of touch screen measurement), the register read address, and the ADC mode bits. Control Register 1 should always be the last register to be programmed prior to starting conversions. Its power-on default value is 0x00. To change any parameter after conversion has begun, the part should first be put into Mode 00, the changes made, and then Control Register 1 reprogrammed, ensuring that it is always the last register to be programmed before conversions begin.

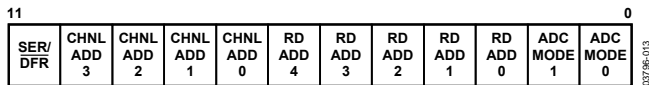

Figure 35. Control Register 1

Control Register 2 sets the timer, reference, polarity, first conversion delay, averaging, and acquisition time. Its power-on default value is 0x00. See the Detailed Register Descriptions section for more information on the control registers.

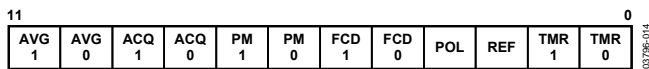

Figure 36. Control Register 2

### CONTROL REGISTER 1

#### ADC Mode (Control Register 1, Bits[1:0])

These bits select the operating mode of the ADC. The AD7877 has three operating modes. These are selected by writing to the mode bits in Control Register 1. If the mode bits are 00, no conversion is performed.

Table 5. Control Register 1 Mode Selection

MODE1	MODE0	Function
0	0	Do not convert (default)
0	1	Single-channel conversion, AD7877 in slave mode
1	0	Sequence 0, AD7877 in slave mode
1	1	Sequence 1, AD7877 in master mode

If the mode bits are 01, a single conversion is performed on the channel selected by writing to the channel bits of Control Register 1 (Bit 7 to Bit 10). At the end of the conversion, if the TMR bits in Control Register 2 are set to 00, the mode bits revert to 00 and the ADC returns to no convert mode until a new conversion is initiated by the host. Setting the TMR bits to a value other than 00 causes the conversion to be repeated, as described in the Timer (Control Register 2, Bits[1:0]) section. The flowchart in Figure 38 shows how the AD7877 operates in Mode 01.

The AD7877 can also be programmed to convert a sequence of selected channels automatically. The two modes for this type of conversion are slave mode and master mode.

For slave mode operation, the channels to be digitized are selected by setting the corresponding bits in Sequencer Register 0. Conversion is initiated by writing 10b to the mode bits of Control Register 1. The ADC then digitizes the selected channels and stores the results in the corresponding results registers. At the end of the conversion, if the TMR bits in Control Register 2 are set to 00, the mode bits revert to 00 and the ADC returns to no convert mode until a new conversion is initiated by the host. Setting the TMR bits to a code other than 00 causes the conversion sequence to be repeated. The flowchart in Figure 39 shows how the AD7877 operates in Mode 10.

For master mode operation, the channels to be digitized are written to Sequencer Register 1. Master mode is then selected by writing 11 to the mode bits in Control Register 1. In this mode, the wake-up on touch feature is active, so conversion does not begin immediately. The AD7877 waits until the screen is touched before beginning the sequence of conversions. The ADC then digitizes the selected channels, and the results are written to the results registers. The AD7877 waits for the screen to be touched again, or for a timer event if the screen remains touched, before beginning another sequence of conversions. The flowchart in Figure 40 shows how the AD7877 operates in Mode 11.

#### ADC Channel (Control Register 1, Bits[10:7])

The ADC channel is selected by Bits [10:7] of Control Register 1 (CHADD3 to CHADD0). In addition, the  $\overline{\text{SER/DFR}}$  bit, Bit 11, selects between single-ended and differential conversion. A complete list of channel addresses is given in Table 6.

For Mode 0 (single-channel) conversion, the channel is selected by writing the appropriate CHADD3 to CHADD0 code to Control Register 1.

For sequential channel conversion, channels to be converted are selected by setting bits corresponding to the channel number in Sequencer Register 1 for slave mode sequencing or Sequencer Register 2 for master mode sequencing.

For both single-channel and sequential conversion, normal (single-ended) conversion is selected by clearing the  $\overline{\text{SER/DFR}}$  bit in Control Register 1. Ratiometric (differential) conversion is selected by setting the  $\overline{\text{SER/DFR}}$  bit.

**Table 6. Codes for Selecting Input Channel and Normal or Ratiometric Conversion**

Channel	SER/DFR	CHADD(3:0)	Analog Input	X Switches	Y Switches	+REF	-REF
0	0	0000	X+ (Y position)	Off	On	Y+	Y-
1	0	0001	Y+ (X position)	On	Off	X+	X-
2	0	0010	Y- (Z2)	X+ off, X- on	Y+ on, Y- off	Y+	X-
3	0	0011	AUX1	Off	Off	V <sub>REF</sub>	GND
4	0	0100	AUX2	Off	Off	V <sub>REF</sub>	GND
5	0	0101	AUX3	Off	Off	V <sub>REF</sub>	GND
6	0	0110	BAT1	Off	Off	V <sub>REF</sub>	GND
7	0	0111	BAT2	Off	Off	V <sub>REF</sub>	GND
8	0	1000	TEMP1	Off	Off	V <sub>REF</sub>	GND
9	0	1001	TEMP2	Off	Off	V <sub>REF</sub>	GND
10	0	1010	X+ (Z1)	X+ OFF, X- ON	Y+ on Y- off	Y+	X-
-	0	1011		Invalid address			
-	0	1100		Invalid address			
-	0	1101		Invalid address			
-	0	1110		Invalid address			
-	0	1111		Invalid address			
0	1	0000	X+ (Y position)	Off	On	V <sub>REF</sub>	GND
1	1	0001	Y+ (X position)	On	Off	V <sub>REF</sub>	GND
2	1	0010	Y- (Z2)	X+ off, X- on	Y+ on, Y- off	V <sub>REF</sub>	GND
3	1	0011	AUX1	Off	Off	V <sub>REF</sub>	GND
4	1	0100	AUX2	Off	Off	V <sub>REF</sub>	GND
5	1	0101	AUX3	Off	Off	V <sub>REF</sub>	GND
6	1	0110	BAT1	Off	Off	V <sub>REF</sub>	GND
7	1	0111	BAT2	Off	Off	V <sub>REF</sub>	GND
8	1	1000	TEMP1	Off	Off	V <sub>REF</sub>	GND
9	1	1001	TEMP2	Off	Off	V <sub>REF</sub>	GND
10	1	1010	X+ (Z1)	X+ off, X- on	Y+ on, Y- off	V <sub>REF</sub>	GND
-	1	1011		Invalid address			
-	1	1100		Invalid address			
-	1	1101		Invalid address			
-	1	1110		Invalid address			
-	1	1111		Invalid address			

**CONTROL REGISTER 2****Timer (Control Register 2, Bits[1:0])**

The TMR bits in Control Register 2 enable the ADC to repeatedly perform a conversion or conversion sequence either once only or at intervals of 512  $\mu$ s, 1.024 ms, or 8.19 ms. In slave mode, the timer starts as soon as the conversion sequence is finished. In master mode, the timer starts at the end of a conversion sequence only if the screen remains touched. If the touch is released at any stage, then the timer stops and, the next time the screen is touched, a conversion sequence begins immediately.

**Table 7. Control Register 2 Timer Selection**

TMR1	TMRO	Function
0	0	Convert only once (default)
0	1	Every 1024 clocks (512 $\mu$ s)
1	0	Every 2048 clocks (1.024 ms)
1	1	Every 16,384 clocks (8.19 ms)

**Int/Ext Reference (Control Register 2, Bit[2])**

If the REF bit in Control Register 2 is 0 (default value), the internal reference is selected. Buffer any connection made to V<sub>REF</sub> while the internal reference is selected (for example, to supply a reference to other circuits). An external power supply should not be connected to this pin while REF is equal to 0, because it might overdrive the internal reference. Because the internal reference is 2.5 V, it operates only with supply voltages down to 2.7 V. Below this value, use an external reference.

If the REF bit is 1, the V<sub>REF</sub> pin becomes an input and the internal reference is powered down. This overrides any setting of the PM bits with regard to the reference. An external reference can then be applied to the REF pin.

**STOPACQ Polarity (Control Register 2, Bit[3])**

This bit should be set according to the polarity of the signal applied to the STOPACQ pin. If that signal is active high, that is, no acquisitions should occur during the high period of the signal, then the POL bit should be set to 1. If the signal is active low, then the POL bit should be 0. The default value for POL is 0.

**First Conversion Delay (Control Register 2, Bits[5:4])**

The first conversion delay (FCD) bits in Control Register 2 program a delay of 500 ns (default), 128  $\mu$ s, 1.024 ms, or 8.19 ms before the first conversion, to allow the ADC time to power up. This delay also occurs before conversion of the X and Y coordinate channels, to allow extra time for screen settling, and after the last conversion in a sequence, to precharge  $\overline{\text{PENIRQ}}$ . If the signal on the STOPACQ pin is being monitored and goes active during the FCD, it is ignored until after the FCD period.

**Table 8. First Conversion Delay Selection**

FCD1	FCD	Function
0	0	1 clock delay (500 ns)
0	1	256 clock delays (128 $\mu$ s)
1	0	2048 clock delays (1.024 ms)
1	1	16,384 clock delays (8.19 ms)

**Power Management (Control Register 2, Bits[7:6])**

The power management (PM) bits in Control Register 2 allow the power management features of the ADC to be programmed. If the PM bits are 00, the ADC is powered down permanently. This overrides any setting of the mode bits in Control Register 1. If the PM bits are 01, the ADC and the reference both power down when the ADC is not converting. If the PM bits are 10, the ADC and reference are powered up continuously. If the PM bits are 11, the ADC, but not the reference, powers down when the ADC is not converting. If the AD7879 is in full power mode (PM=10), the master sequencer should not be used. PM bits must be set to 01 or 11 when using the master sequencer.

**Table 9. Power Management Selection**

PM1	PM0	Function
0	0	Power down continuously (default)
0	1	Power down ADC and reference when ADC is not converting (powers up with FCD at start of a conversion)
1	0	Powered up continuously
1	1	Power down ADC when ADC is not converting (powers up with FCD at start of conversion)

**Acquisition Time (Control Register 2, Bits[9:8])**

The ACQ bits in Control Register 2 allow the selection of acquisition times for the ADC of 2  $\mu$ s (default), 4  $\mu$ s, 8  $\mu$ s, or 16  $\mu$ s. The user can program the ADC with an acquisition time suitable for the type of signal being sampled. For example, signals with large RC time constants can require longer acquisition times.

**Table 10. Acquisition Time Selection**

ACQ1	ACQ0	Function
0	0	4 clock periods (2 $\mu$ s)
0	1	8 clock periods (4 $\mu$ s)
1	0	16 clock periods (8 $\mu$ s)
1	1	32 clock periods (16 $\mu$ s)

**Averaging (Control Register 2, Bits[11:10])**

Signals from touch screens can be extremely noisy. The AVG bits in Control Register 2 allow multiple conversions to be performed on each input channel and averaged to reduce noise. A single conversion can be selected (no averaging), which is the default, or 4, 8, or 16 conversions can be averaged. Only the final averaged result is written into the results register.

**Table 11. Averaging Selection**

AVG1	AVG0	Function
0	0	ADC performs 1 average per channel
0	1	ADC performs 4 averages per channel
1	0	ADC performs 8 averages per channel
1	1	ADC performs 16 averages per channel

**SEQUENCER REGISTERS**

There are two sequencer registers on the AD7877. Sequencer Register 0 controls the measurements performed during a slave mode sequence. Sequencer Register 1 controls the measurements performed during a master mode sequence.

To include a measurement in a slave mode or master mode sequence, the relevant bit must be set in Sequencer Register 0 or Sequencer Register 1. Setting Bit 11 includes a measurement on ADC Channel 0 in the sequence, which is the Y positional measurement. Setting Bit 10 includes a measurement on ADC Channel 1 (X+ measurement), and so on, through Bit 1 for Channel 10. Figure 37 illustrates the correspondence between the bits in the sequencer registers and the various measurements. Bit 0 in both sequencer registers is not used. See also the Detailed Register Descriptions section.

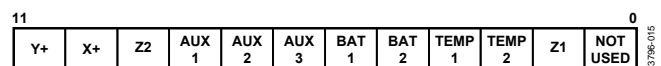
*Figure 37. Sequencer Register*

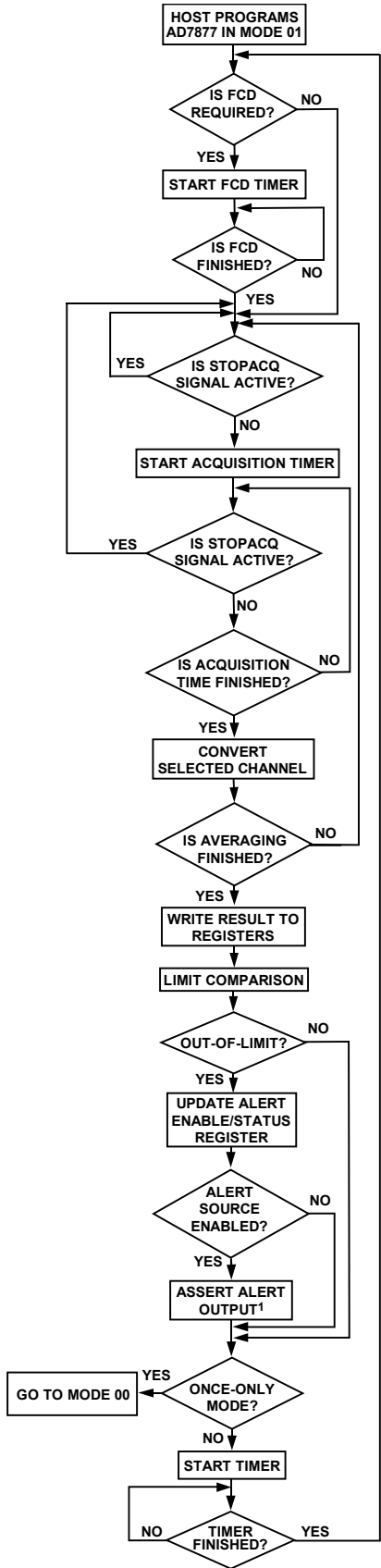

¹SEE SEQUENCER REGISTERS SECTION.

Figure 38. Single Channel Operation

03796-016

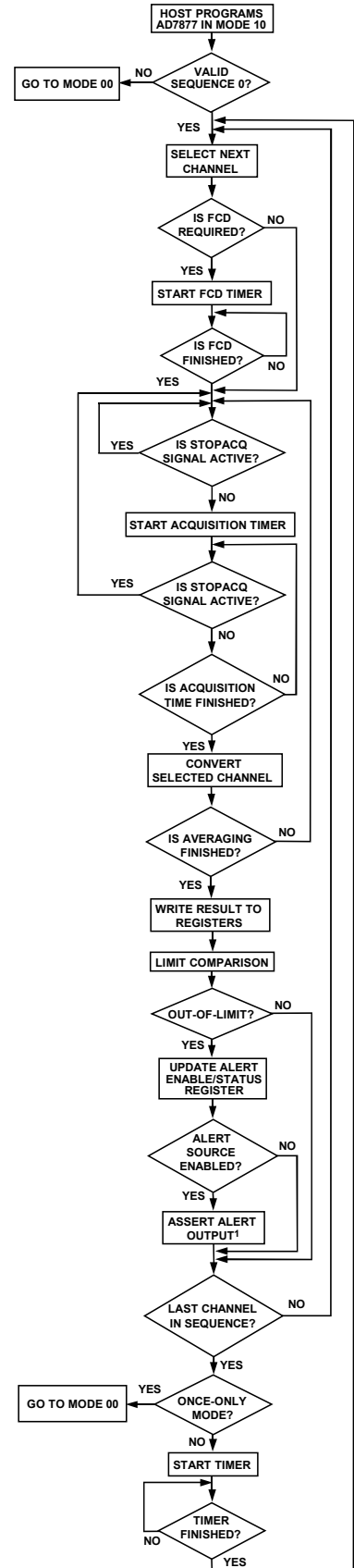

¹SEE SEQUENCER REGISTERS SECTION.

Figure 39. Slave Mode Sequencer Operation

03796-017

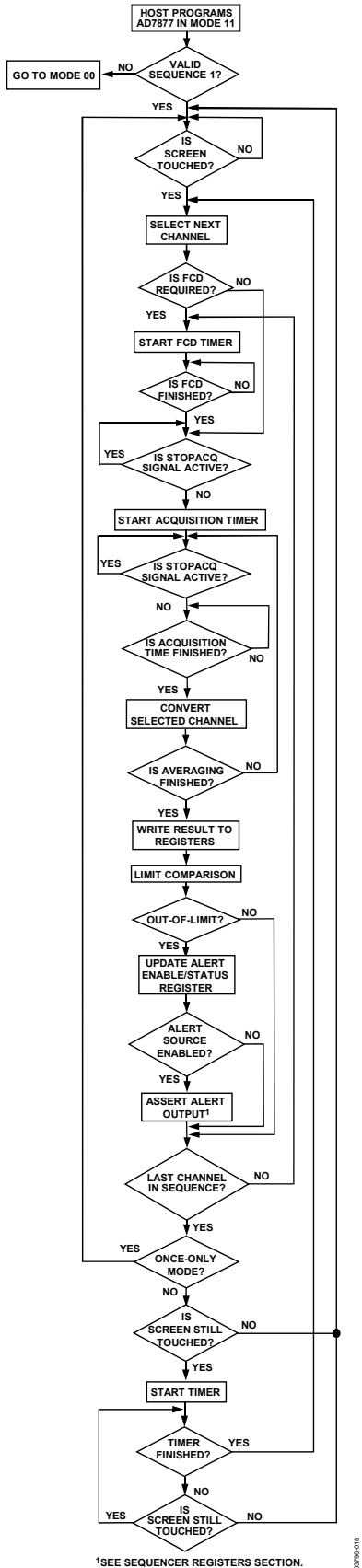

Figure 40. Master Mode Sequencer Operation

INTERRUPTS

Data Available Output ( $\overline{DAV}$ )

The data available output ( $\overline{DAV}$ ) indicates that new ADC data is available in the results registers. While the ADC is idle or is converting,  $\overline{DAV}$  is high. Once the ADC has finished converting and new data has been written to the results registers,  $\overline{DAV}$  goes low. Taking  $\overline{DAV}$  low to read the registers resets  $\overline{DAV}$  to a high condition.  $\overline{DAV}$  is also reset, if a new conversion is started by the AD7877 because the timer expired. The host should attempt to read the results registers only when  $\overline{DAV}$  is low.

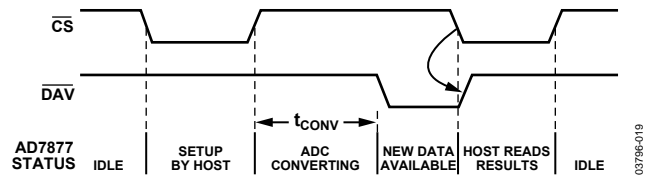

Figure 41. Operation of  $\overline{DAV}$  Output

$\overline{DAV}$  is useful as a host interrupt in master mode. In this mode, the host can program the AD7877 to automatically perform a sequence of conversions, and can be interrupted by  $\overline{DAV}$  at the end of each conversion sequence.

When the on-board timer is programmed to perform automatic conversions, a limited time is available to the host to read the results registers before another sequence of conversions begins. The  $\overline{DAV}$  signal is reset high when the timer expires, and the host should not access the results registers while  $\overline{DAV}$  is high.

Figure 42 shows the worst-case timings for reading the results registers after  $\overline{DAV}$  has gone low. The timer is set at a minimum, and the conversion sequence includes all 11 possible ADC channels.  $t_1$  is the time taken for acquisition and conversion on one ADC channel.  $t_2$  shows the minimum timer delay, that is, 1024 clock periods.  $t_3$  is the time taken to read all 11 result registers. If the host wants to read all 11 registers, then it must do so before the timer expires.  $t_4$  is the maximum time allowable between  $\overline{DAV}$  going low and the host beginning to read the results registers. If  $t_4$  is exceeded, then all registers cannot be read before the start of a new conversion, and incorrect data could be read by the host.

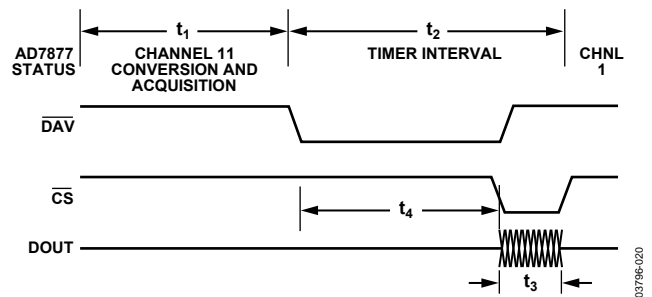

Figure 42. Timing for Reads after  $\overline{DAV}$  Goes Low

If  $f_{DCLK} = 20 \text{ MHz}$  (maximum), then  $t_{DCLK} = 50 \text{ ns}$ .

$$t_2 = 512 \mu\text{s} \text{ with timer set to } 1024 \text{ (TMR bits} = 01\text{b)}$$

$$t_{WRITE} = t_{READ} = 16 \text{ CLK period} \times t_{DCLK} = 800 \text{ ns}$$

$t_3 =$  maximum time taken to write read address and read 11 registers =  $800 \text{ ns (write)} + [800 \text{ ns (read)} \times 11] = 9.6 \mu\text{s}$ .

$$t_{MAX} = t_2 - t_3 = 512 \mu\text{s} - 9.6 \mu\text{s} = 502.4 \mu\text{s}$$

### Pen Interrupt ( $\overline{\text{PENIRQ}}$ )

The pen interrupt request output ( $\overline{\text{PENIRQ}}$ ) goes low whenever the screen is touched. The pen interrupt equivalent output circuitry is outlined in Figure 43. This is a digital logic output with an internal pull-up resistor of  $50 \text{ k}\Omega$ , which means it does not need an external pull-up. The  $\overline{\text{PENIRQ}}$  output idles high. The  $\overline{\text{PENIRQ}}$  circuitry is always enabled, except during conversions.

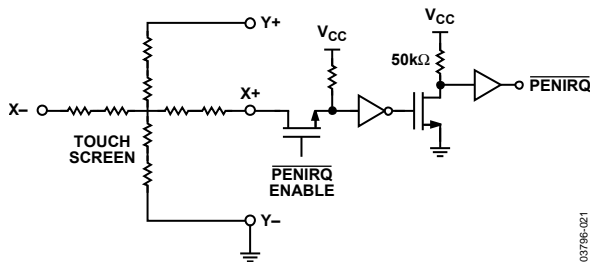

Figure 43.  $\overline{\text{PENIRQ}}$  Output Equivalent Circuit

When the screen is touched,  $\overline{\text{PENIRQ}}$  goes low. This generates an interrupt request to the host. When the screen touch ends, and if the ADC is idle,  $\overline{\text{PENIRQ}}$  immediately goes high. If the ADC is converting,  $\overline{\text{PENIRQ}}$  goes high once the ADC becomes idle. The  $\overline{\text{PENIRQ}}$  operation for these two conditions is shown in Figure 44.

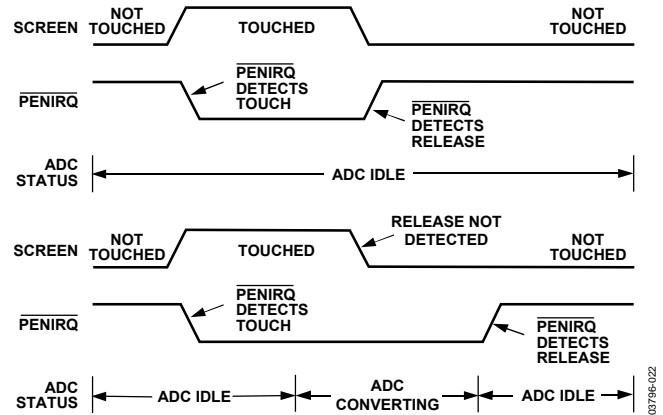

Figure 44.  $\overline{\text{PENIRQ}}$  Operation for ADC Idle and ADC Converting

### SYNCHRONIZING THE AD7877 TO THE HOST CPU

The two suggested methods for synchronizing the AD7877 to its host CPU are slave mode, in which the mode bits can be either 01b or 10b, and master mode, in which the mode bits are 11b.

In slave mode,  $\overline{\text{PENIRQ}}$  can be used as an interrupt to the host. When  $\overline{\text{PENIRQ}}$  goes low to indicate that the screen has been touched, the host is awakened. The host can then program the AD7877 to begin converting in either Mode 01b or Mode 10b, and can read the result registers after the conversions are completed.

In master mode,  $\overline{\text{DAV}}$  can also be used as an interrupt to the host. However, the host should first initialize the AD7877 in Mode 11b. The host can then go into sleep mode to conserve power. The wake-up on touch feature of the AD7877 is active in this mode, therefore, when the screen is touched, the programmed sequence of conversions begins automatically. When the  $\overline{\text{DAV}}$  signal asserts, the host reads the new data available in the AD7877 results registers and returns to sleep mode. This method can significantly reduce the load on the host.

## 8-BIT DAC

The AD7877 features an on-chip 8-bit DAC for LCD contrast control. The DAC can be configured for voltage output by clearing Bit 2 of the DAC register (Address 1110b), or for current output by setting this bit.

The output voltage range can be set to 0 to  $V_{CC}/2$  by clearing Bit 0 of the DAC register, or to 0 to  $V_{CC}$  by setting this bit. In current mode, the output range is selectable by an external resistor,  $R_{RNG}$ , connected between the ARNG pin and GND. This sets the full-scale output current according to the following equations:

$$I_{FS} = V_{CC}/(R_{RNG} \times 6)$$

therefore,

$$R_{RNG} = V_{CC}/(I_{FS} \times 6) \quad (5)$$

In current mode, the DAC sinks current, that is, positive current flows into ground. The maximum output current is 1000  $\mu\text{A}$ . The DAC is updated by writing to Address 1110b of the DAC register. The 8 MSBs of the data-word are used for DAC data.

The most effective way to control LCD contrast with the DAC is to use it to control the feedback loop of the dc-to-dc converter that supplies the LCD bias voltage, as shown in Figure 45. The bias voltage for graphic LCDs is typically in the range of 20 V to 25 V, and the dc-to-dc converter usually has a feedback loop that attenuates the output voltage and compares it with an internal reference voltage.

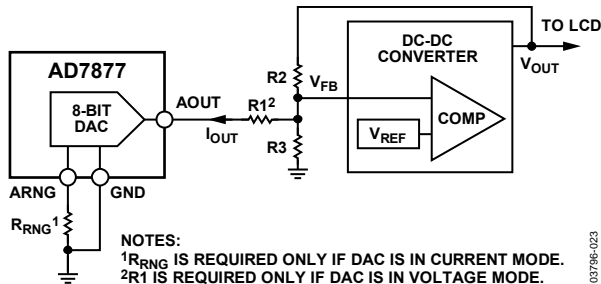

Figure 45. Using the DAC to Adjust LCD Contrast

The circuit operates as follows. If the DAC is in current mode when the DAC output is zero, it has no effect on the feedback loop. Regardless of what the DAC does, the feedback loop maintains the voltage across  $R_4$ ,  $V_{FB}$ , equal to  $V_{REF}$ , and the output voltage,  $V_{OUT}$ , is

$$V_{REF} \times (R_2 + R_3)/R_3$$

As the DAC output is increased, it increases the feedback current, so the voltage across  $R_2$  and, therefore, the output voltage also increase. Note that the voltage across  $R_3$  does not change. This is important for calculation of the adjustment range.

In current mode, it is quite easy to calculate the resistor values to give the required adjustment range in  $V_{OUT}$  using the following steps:

1. Find the required maximum and minimum values of  $V_{OUT}$  from the LCD manufacturer's data
2. Decide on the current around the feedback loop. For reasonable accuracy of the output voltage, this current should be at least 100 times the input bias current of the dc-to-dc converter's comparator

3. Calculate  $R_3$  using the following equation:

$$R_3 = V_{FB}/I_{FB} = V_{REF}/I_{FB}$$

4. Calculate  $R_2$  for the minimum value of  $V_{OUT}$ , when the DAC has no effect

$$R_2 = R_3(V_{OUT(MIN)} - V_{REF})/V_{REF}$$

5. Because the voltage across  $R_3$  does not change, subtract  $V_{REF}$  from  $V_{OUT(MAX)}$  and  $V_{OUT(MIN)}$  to get the maximum and minimum voltages across  $R_2$

6. Calculate the change in feedback current between minimum and maximum output voltages

$$I = V_{R_2(MAX)}/R_2 - V_{R_2(MIN)}/R_2$$

This is the required full-scale current of the DAC.

7. Calculate  $R_{RNG}$  from Equation 5

Example:

1.  $V_{CC} = 5 \text{ V}$   
 $V_{OUT(MIN)}$  is 20 V and  $V_{OUT(MAX)}$  is 25 V  
 $V_{REF}$  is 1.25 V
2. Allow 100  $\mu\text{A}$  around the feedback loop.
3.  $R_3 = 1.25 \text{ V}/100 \mu\text{A} = 12.5 \text{ k}$   
 Use the nearest preferred value of 12 k and recalculate the feedback current as

$$I_{FB} = 1.25 \text{ V}/12 \text{ k} = 104 \mu\text{A}$$

4.  $R_2 = (20 \text{ V} - 1.25 \text{ V})/104 \mu\text{A} = 180 \text{ k}$
5.  $I = 23.75 \text{ V}/180 \text{ k} - 18.75 \text{ V}/180 \text{ k} = 28 \mu\text{A}$
6.  $R_{RNG} = 5 \text{ V}/(6 \times 28 \mu\text{A}) = 30 \text{ k}$

In voltage mode, the circuit operation depends on whether the maximum output voltage of the DAC exceeds the dc to dc converter  $V_{REF}$ .

When the DAC output voltage is zero, it sinks the maximum current through R1. The feedback current and, therefore,  $V_{OUT}$  are at their maximum. As the DAC output voltage increases, the

sink current and, thus, the feedback current decrease, and  $V_{OUT}$  falls. If the DAC output exceeds  $V_{REF}$ , it starts to source current, and  $V_{OUT}$  has to further decrease to compensate. When the DAC output is at full scale,  $V_{OUT}$  is at its minimum.

Note that the effect of the DAC on  $V_{OUT}$  is opposite in voltage mode to that in current mode. In current mode, increasing DAC code increases the sink current, so  $V_{OUT}$  increases with increasing DAC code. In voltage mode, increasing DAC code increases the DAC output voltage, reducing the sink current.

Calculate the resistor values as follows:

1. Decide on the feedback current as before.
2. Calculate the parallel combination of R1 and R3 when the DAC output is zero

$$R_P = V_{REF}/I_{FB}$$

3. Calculate R2 as before, but use  $R_P$  and  $V_{OUT(MAX)}$

$$R_2 = R_P(V_{OUT(MAX)} - V_{REF})/V_{REF}$$

4. Calculate the change in feedback current between minimum and maximum output voltages as before using

$$I = V_{R2(MAX)}/R_2 - V_{R2(MIN)}/R_2$$

This is equal to the change in current through R1 between zero output and full scale, which is also given by

$$\begin{aligned} I &= \text{current at zero} - \text{current at full scale} \\ &= V/R_1 - (V_{REF} - V)/R_1 \\ &= V/R_1 \end{aligned}$$

$$5. \quad R_1 = V_{FS}/I$$

6. Calculate R3 from R1 and R using

$$R_3 = (R_1 \times R_P)/(R_1 - R_P)$$

Example:

1.  $V_{CC} = 5 \text{ V}$  and  $V_{FS} = V_{CC}$ .  $V_{OUT(MIN)}$  is 20 V and  $V_{OUT(MAX)}$  is 25 V.  $V_{REF}$  is 1.25 V. Allow 100  $\mu\text{A}$  around the feedback loop.

$$2. \quad R_P = 1.25 \text{ V}/100 \mu\text{A} = 12.5 \text{ k} \Omega$$

$$3. \quad R_2 = 12.5 \text{ k} \Omega \times (25 - 1.25) / 1.25 = 237 \text{ k} \Omega$$

Use the nearest preferred value of 240 k  $\Omega$ .

$$4. \quad I = 25 \text{ V}/240 \text{ k} \Omega - 20 \text{ V}/240 \text{ k} \Omega = 21 \mu\text{A}$$

$$5. \quad R_1 = 5 \text{ V}/21 \mu\text{A} = 238 \text{ k} \Omega$$

Use the nearest preferred value of 250 k  $\Omega$ .

$$6. \quad R_3 = (180 \text{ k} \Omega \times 12.5 \text{ k} \Omega) / (180 \text{ k} \Omega - 12.5 \text{ k} \Omega) = 13.4 \text{ k} \Omega$$

Use nearest preferred value of 13 k  $\Omega$ .

The actual adjustment range using these values is 21 V to 26 V.

## SERIAL INTERFACE

The AD7877 is controlled via a 3-wire serial peripheral interface (SPI). The SPI has a data input pin (DIN) for inputting data to the device, a data output pin (DOUT) for reading data back from the device, and a data clock pin (DCLK) for clocking data into and out of the device. A chip-select pin ( $\overline{CS}$ ) enables or disables the serial interface.

### WRITING DATA

Data is written to the AD7877 in 16-bit words. The first four bits of the word are the register address that directs the AD7877 to the register to write to. The next 12 bits are data. How the AD7877 handles the data bits depends on the register address.

Register Address 0000b is a dummy address, which does nothing. Register Addresses 0010b to Register Address 1110b are 12-bit registers that perform various functions as described in the register map.

Register Address 1111b is not a physical register, but enables an extended writing mode that allows writing to the GPIO configuration registers. When the register address is 1111b, the next four bits of the data-word are the address of a GPIO configuration register and the eight LSBs are the GPIO configuration data. For details on the configuration of the GPIO pins, see the General-Purpose I/O Pins section.

Register Address 0001b is a physical register, Control Register 1, but this is a special register. It contains data for setting up the ADC channel and operating mode, but Bit 20 to Bit 6 compose the register address for reading. These define the register that is read back during the next read operation. Control Register 1 should be the last register in the AD7877 to be programmed before starting a conversion. The three types of data-words used for writing are shown in Figure 46.

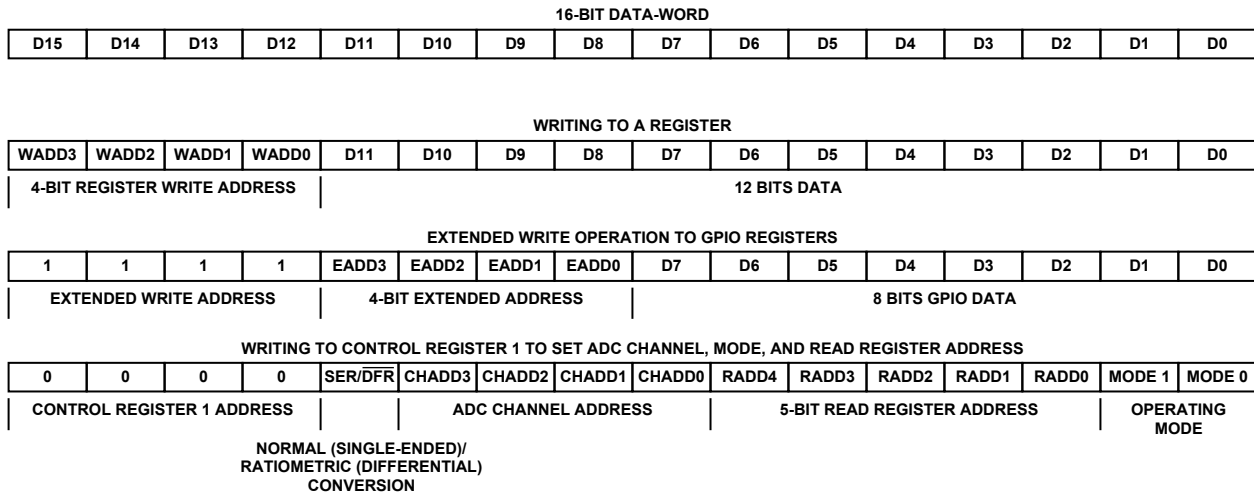
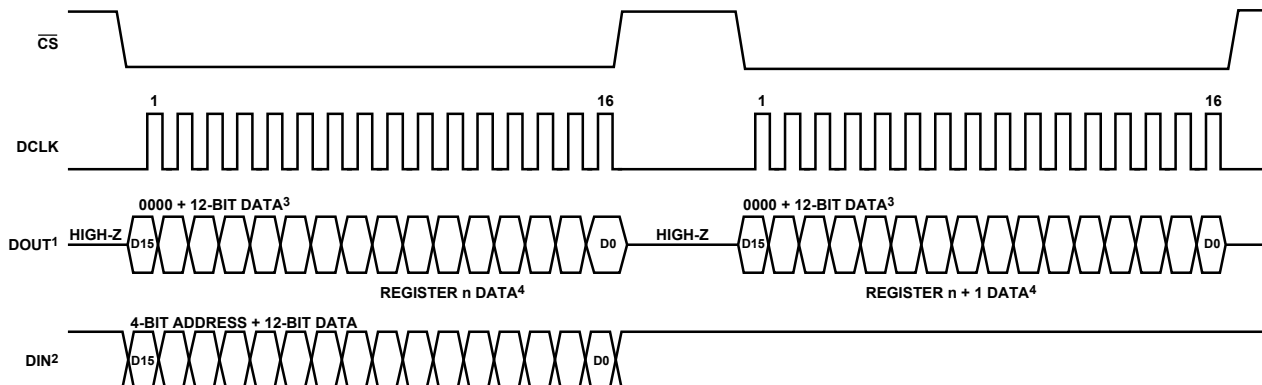

Figure 46. Designation of Data-Word Bits in AD7877 Write Operations



**NOTES:**

- <sup>1</sup>DATA IS CLOCKED OUT ON THE FALLING EDGE OF DCLK.
- <sup>2</sup>INPUT DATA IS SAMPLED ON THE RISING EDGE OF DCLK.
- <sup>3</sup>FOR 8-BIT REGISTERS, 8 LEADING ZEROS PRECEDE 8 BITS OF DATA.
- <sup>4</sup>REGISTER READ ADDRESS INCREMENTS AUTOMATICALLY, PROVIDED THAT A NEW ADDRESS IS NOT WRITTEN TO CONTROL REGISTER 1.

Figure 47. Overall Read/Write Timing

## WRITE TIMING

No serial interface operations can take place when  $\overline{CS}$  is high. To write to the AD7877,  $\overline{CS}$  must be taken low. To write to the device, a burst of 16 clock pulses is input to DCLK while the write data is input to DIN. Data is clocked in on the rising edge of DCLK. If multiple write operations are to be performed,  $\overline{CS}$  must be taken high after the end of each write operation before another write operation can be performed by taking  $\overline{CS}$  low again.

## READING DATA

Data is available on the DOUT pin following the falling edge of  $\overline{CS}$ , when the device is being clocked. The MSB is clocked out on the falling edge of  $\overline{CS}$ , with subsequent data bits clocked out on the falling edge of DCLK.

After  $\overline{CS}$  is taken low and the device is clocked, the AD7877 outputs data from the register whose read address is currently stored in Control Register 1. Once this data has been output, the address increments automatically.  $\overline{CS}$  must be taken high between reads. When  $\overline{CS}$  is taken low again, reading continues

from the register whose read address is in Control Register 1, provided that a write operation does not change the address. If the register read address reaches 11111b, it is then reset to zero. This feature allows all registers to be read out in sequence without having to explicitly write all their addresses to the device.

Note that because data-words are 16 bits long, but the data registers are only 12 bits long, or 8 bits in the case of GPIO registers, the first four bits of a readback data-word are zeros, or the first 8 bits in the case of a GPIO register.

## V<sub>DRIVE</sub> PIN

The supply voltage to all pins associated with the serial interface ( $\overline{DAV}$ , DIN, DOUT, DCLK,  $\overline{CS}$ ,  $\overline{PENIRQ}$ , and  $\overline{ALERT}$ ) is separate from the main  $V_{CC}$  supply and is connected to the  $V_{DRIVE}$  pin. This allows the AD7877 to be connected directly to processors whose supply voltage is less than the minimum operating voltage of the AD7877, in fact, as low as 1.7 V.

## GENERAL-PURPOSE I/O PINS

The AD7877 has one dedicated general-purpose logic input/output pin (GPIO4), and any or all of the three auxiliary analog inputs can also be reconfigured as GPIOs. Associated with the GPIOs are two 8-bit control registers and one 8-bit data register that are accessed using the extended write mode.

As described in the Reading Data section, GPIO registers are written to using the extended writing mode. The first four bits of the data-word must be 1111b to access the extended writing map, and the next four bits are the GPIO register address. This leaves 8 bits for the GPIO register data, because all GPIO registers are 8 bits.

The GPIO control registers are located at the 0000b and 0001b extended writing map addresses, and the GPIO data register is at Address 0010b. GPIO registers are read in the same way as other registers, by writing a 5-bit address to Control Register 1. The GPIO registers are located at Read Addresses 11011b to Read Address 11101b.

### GPIO CONFIGURATION

Each GPIO pin is configured by four bits in one of the GPIO control registers and has a data bit in the GPIO data register. The GPIO configuration bits are described in the following sections and in Table 12. Also see the Detailed Register Descriptions section.

#### Enable (EN)

These bits enable or disable the GPIO pins. When EN = 0, the corresponding GPIO pin is configured as the alternate function (AUX input). The other GPIO configuration bits have no effect, if the particular GPIO is not enabled. When EN = 1, the pin is configured as a GPIO pin. GPIO4, which does not have an alternate function, does not have an EN bit; it is always enabled.

#### Direction—DIR

These bits set the direction of the GPIO pins. When DIR = 0, the pin is an output. Setting or clearing the relevant bit in the GPIO data register outputs a value on the corresponding GPIO pin. The output value depends on the POL bit.

When DIR = 1, the pin is an input. An input value on the relevant GPIO pin sets or clears the corresponding bit in the GPIO data register, depending on the POL bit. A GPIO data register bit is read-only when DIR = 1 for that GPIO.

#### Polarity (POL)

When POL = 0, the GPIO pin is active low. When POL = 1, the GPIO pin is active high. How this bit affects the GPIO operation also depends on the DIR bit.

If POL = 1 and DIR = 1, a 1 at the input pin sets the corresponding GPIO data register bit to 1. A 0 at the input pin clears the corresponding GPIO data bit to 0.

If POL = 1 and DIR = 0, a 1 in the GPIO data register bit puts a 1 on the corresponding GPIO output pin. A 0 in the GPIO data register bit puts a 0 on the GPIO output pin.

If POL = 0 and DIR = 1, a 1 at the input pin sets the corresponding GPIO data bit to 0. A 0 at the input pin clears the corresponding GPIO data bit to 1.

If POL = 0 and DIR = 0, a 1 in the GPIO data register bit puts a 0 on the corresponding GPIO output pin. A 0 in the GPIO data register bit puts a 1 on the GPIO output pin.

#### $\overline{\text{ALERT}}$ Enable (ALEN)

GPIOs can operate as interrupt sources to trigger the  $\overline{\text{ALERT}}$  output. This is controlled by the  $\overline{\text{ALERT}}$  enable (ALEN) bits in the GPIO configuration registers. When ALEN = 1, the corresponding GPIO can trigger an  $\overline{\text{ALERT}}$ . When ALEN = 0, the corresponding GPIO cannot cause the  $\overline{\text{ALERT}}$  output to assert.

$\overline{\text{ALERT}}$  is asserted low if any GPIO data register bit is set when the GPIO is configured as an input. The GPIO data bit is set if a 1 appears on the GPIO input pin when POL = 1, or if a 0 appears on the GPIO input pin when POL = 0.  $\overline{\text{ALERT}}$  is triggered only when the GPIO is configured as an input, that is, when DIR = 1.  $\overline{\text{ALERT}}$  can never be triggered by a GPIO that is configured as an output, that is, DIR = 0.

#### $\overline{\text{ALERT}}$ Output

The  $\overline{\text{ALERT}}$  pin is an alarm or interrupt output that goes low if any one of a number of interrupt sources is asserted. The results of high and low limit comparisons on the AUX1, BAT1, BAT2, and TEMP1 channels are interrupt sources. An out-of-limit comparison sets a status bit in the alert status/mask register (Address 00011b). There are separate status bits for both the high and low limits on each channel to indicate which limit was exceeded. The interrupt sources can be masked out by clearing the corresponding enable bit in this register. There is one enable bit per channel.

$\overline{\text{ALERT}}$  is also asserted if an input on a GPIO pin sets a bit in the GPIO data register, as explained in the  $\overline{\text{ALERT}}$  Enable (ALEN) section. GPIO interrupts can be disabled by clearing the corresponding ALEN bit in the GPIO control registers.

The interrupt source can be identified by reading the GPIO data register and the alert status/enable register.  $\overline{\text{ALERT}}$  remains asserted until the source of the interrupt has been masked out or removed.



## GROUNDING AND LAYOUT

It is recommended that the ground pins, AGND and DGND, be shorted together as close as possible to the device itself on the user's PCB.

For more information on grounding and layout considerations for the AD7877, refer to the AN-577 Application Note, *Layout and Grounding Recommendations for Touch Screen Digitizers*.

### PCB DESIGN GUIDELINES FOR CHIP SCALE PACKAGES

The lands on the chip scale package (CP-32) are rectangular. The printed circuit board pad for these should be 0.1 mm longer than the package land length and 0.05 mm wider than the package land width. To ensure that the solder joint size is maximized, center the land on the pad.

The bottom of the chip scale package has a central thermal pad. The thermal pad on the printed circuit board should be at least as large as this exposed pad. On the printed circuit board, provide a clearance of at least 0.25 mm between the thermal pad and the inner edges of the pad pattern to ensure that shorting is avoided.

Using thermal vias on the printed circuit board thermal pad improves the thermal performance of the package. If vias are used, incorporate them in the thermal pad at a 1.2 mm pitch grid. Keep the via diameter between 0.3 mm and 0.33 mm. The via barrel should be plated with 1 oz. copper to plug the via.

The user should connect the printed circuit board thermal pad to AGND.

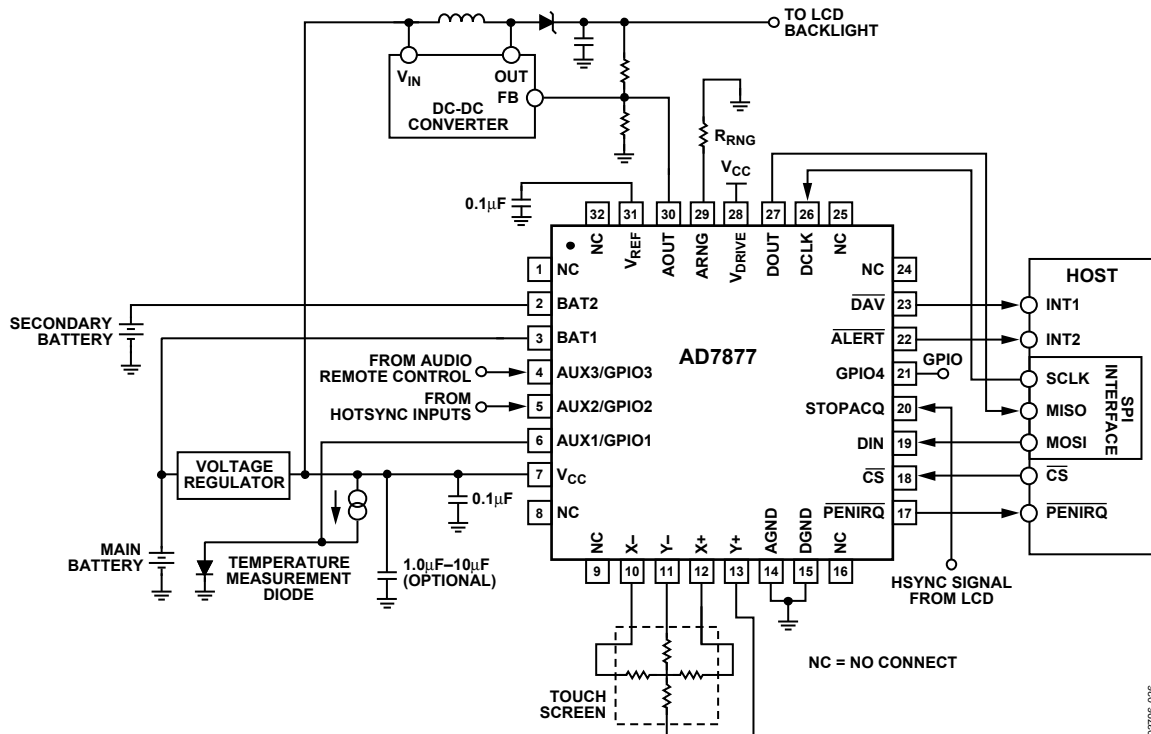

Figure 48. Typical Application Circuit

03796-026

## REGISTER MAPS

Table 13. Write Register Map

Register Address					Hex	Register Name	Description
Binary							
WADD3	WADD2	WADD1	WADD0				
0	0	0	0	0	None	Unused; writing to this address has no effect	
0	0	0	1	1	Control Register 1	Contains ADC channel address, register read address, and ADC mode	
0	0	1	0	2	Control Register 2	Contains ADC averaging, acquisition time, power management, first conversion delay, STOPACQ polarity, and reference and timer settings	
0	0	1	1	3	Alert status/enable register	Contains status of high/low limit comparisons for TEMP1, BAT1, BAT2, and AUX1, and enable bits to allow these channels to become interrupt sources	
0	1	0	0	4	AUX1 high limit	User-programmable AUX1 upper limit	
0	1	0	1	5	AUX1 low limit	User-programmable AUX1 lower limit	
0	1	1	0	6	BAT1 high limit	User-programmable BAT1 upper limit	
0	1	1	1	7	BAT1 low limit	User-programmable BAT1 lower limit	
1	0	0	0	8	BAT2 high limit	User-programmable BAT2 upper limit	
1	0	0	1	9	BAT2 low limit	User-programmable BAT2 lower limit	
1	0	1	0	A	TEMP1 low limit	User-programmable TEMP1 lower limit	
1	0	1	1	B	TEMP1 high limit	User-programmable TEMP1 upper limit	
1	1	0	0	C	Sequencer Register 0	Contains channel selection data for slave mode (software) sequencing	
1	1	0	1	D	Sequencer Register 1	Contains channel selection data for master mode (hardware) sequencing	
1	1	1	0	E	DAC register	Contains DAC data and setup information	
1	1	1	1	F	Extended write	Not a physical register; enables writing to extended writing map	

Table 14. Extended Writing Map

Register Address					Hex	Register Name	Description
Binary							
EADD3	EADD2	EADD1	EADD0				
0	0	0	0	0	GPIO Control Register 1	Contains polarity, direction, enabling, and interrupt enabling settings for GPIO1 and GPIO2	
0	0	0	1	1	GPIO Control Register 2	Contains polarity, direction, enabling, and interrupt enabling settings for GPIO3 and GPIO4	
0	0	1	0	2	GPIO data	Contains GPIO1 to GPIO4 data	

Table 15. Read Register Map

Register Address						Register Name	Description
Binary					Hex		
RADD4	RADD3	RADD2	RADD1	RADD0		Hex	Register Name
0	0	0	0	0	00	None	Reads back all zeros
0	0	0	0	1	01	Control Register 1	See Table 13
0	0	0	1	0	02	Control Register 2	See Table 13
0	0	0	1	1	03	Alert status/enable register	See Table 13
0	0	1	0	0	04	AUX1 high limit	See Table 13
0	0	1	0	1	05	AUX1 low limit	See Table 13
0	0	1	1	0	06	BAT1 high limit	See Table 13
0	0	1	1	1	07	BAT1 low limit	See Table 13
0	1	0	0	0	08	BAT2 high limit	See Table 13
0	1	0	0	1	09	BAT2 low limit	See Table 13
0	1	0	1	0	0A	TEMP1 low limit	See Table 13
0	1	0	1	1	0B	TEMP1 high limit	See Table 13
0	1	1	0	0	0C	Sequencer Register 0	See Table 13
0	1	1	0	1	0D	Sequencer Register 1	See Table 13
0	1	1	1	0	0E	DAC register	See Table 13
0	1	1	1	1	0F	None	Factory use only
1	0	0	0	0	10	X+	Measurement at X+ input for Y position
1	0	0	0	1	11	Y+	Measurement at Y+ input for X position
1	0	0	1	0	12	Y- (Z2)	Measurement at Y- input for touch-pressure calculation Z2
1	0	0	1	1	13	AUX1	Auxiliary Input 1 measurement
1	0	1	0	0	14	AUX2	Auxiliary Input 2 measurement
1	0	1	0	1	15	AUX3	Auxiliary Input 3 measurement
1	0	1	1	0	16	BAT1	Battery Input 1 measurement
1	0	1	1	1	17	BAT2	Battery Input 2 measurement
1	1	0	0	0	18	TEMP1	Single-ended temperature measurement
1	1	0	0	1	19	TEMP2	Differential temperature measurement
1	1	0	1	0	1A	X+ (Z1)	Measurement at X+ input for touch-pressure calculation Z1
1	1	0	1	1	1B	GPIO Control Register 1	See Table 14
1	1	1	0	0	1C	GPIO Control Register 2	See Table 14
1	1	1	0	1	1D	GPIO data	See Table 14
1	1	1	1	0	1E	None	Factory use only
1	1	1	1	1	1F	None	Factory use only

## DETAILED REGISTER DESCRIPTIONS

### Register Name: Control Register 1

Write Address: 0001

Read Address: 00001

Default Value: 0x000

Type: Read/write

**Table 16.**

Bit	Name	Read/Write	Description
0	MODE0	R/W	LSB of ADC mode code
1	MODE1	R/W	MSB of ADC mode code 00 = no conversion 01 = single conversion 10 = conversion sequence (slave mode) 11 = conversion sequence (master mode)
2	RD0	R/W	LSB of register read address; to read a register, its address must first be written to Control Register 1
3	RD1	R/W	Bit 1 of register read address; to read a register, its address must first be written to Control Register 1
4	RD2	R/W	Bit 2 of register read address; to read a register, its address must first be written to Control Register 1
5	RD3	R/W	Bit 3 of register read address; to read a register, its address must first be written to Control Register 1
6	RD4	R/W	MSB of register read address; to read a register, its address must first be written to Control Register 1
7	CHADD0	R/W	LSB of ADC channel address
8	CHADD1	R/W	Bit 1 of ADC channel address
9	CHADD2	R/W	Bit 2 of ADC channel address
10	CHADD3	R/W	MSB of ADC channel address 0000 = X+ input (Y position) 0001 = Y+ input (X position) 0010 = Y- (Z2) input (used for touch-pressure calculation) 0011 = Auxiliary Input 1 (AUX1) 0100 = Auxiliary Input 2 (AUX2) 0101 = Auxiliary Input 3 (AUX3) 0110 = Battery Monitor Input 1 (BAT1) 0111 = Battery Monitor Input 2 (BAT2) 1000 = Temperature Measurement 1 (used for single conversion) 1001 = Temperature Measurement 2 (used for differential measurement method) 1010 = X+ (Z1) input (used for touch-pressure calculation)
11	SER/DFR	R/W	Selects normal (single-ended) or ratiometric (differential) conversion 0 = ratiometric (differential) 1 = normal (single-ended)

# AD7877

## Register Name: Control Register 2

Write Address: 0010

Read Address: 00010

Default Value: 0x000

Type: Read/write

Table 17.

Bit	Name	Read/Write	Description
0	TMR0	R/W	LSB of conversion interval timer
1	TMR1	R/W	MSB of conversion interval timer 00 = convert only once 01 = every 1024 clock periods (512 $\mu$ s) 10 = every 2048 clock periods (1.024 ms) 11 = every 16,384 clock periods (8.19 ms)
2	REF	R/W	Selects internal or external reference 0 = internal reference 1 = external reference
3	POL	R/W	Indicates polarity of signal on STOPACQ pin 0 = active low 1 = active high
4	FCD0	R/W	LSB of first conversion delay
5	FCD1	R/W	MSB of first conversion delay This delay occurs before the first conversion after powering up the ADC, before converting the X and Y coordinate channels to allow settling, and after the last conversion to allow $\overline{\text{PENIRQ}}$ precharge 00 = 1 clock period delay (500 ns) 01 = 256 clock periods delay (128 $\mu$ s) 10 = 2048 clock periods delay (1.024 ms) 11 = 16,384 clock periods delay (8.19 ms)
6	PM0	R/W	LSB of ADC power management code
7	PM1	R/W	MSB of ADC power management code 00 = ADC and reference powered down continuously For the following codes, regardless of PM bits, the reference is always powered down if the REF bit is 1: 01 = ADC and reference powered down when not converting 10 = ADC and reference powered up continuously (master sequencer does not work if PM = 10) 11 = ADC powered down when not converting, reference powered up
8	ACQ0	R/W	LSB of ADC acquisition time
9	ACQ1	R/W	MSB of ADC acquisition time 00 = 4 clock periods (2 $\mu$ s) 01 = 8 clock periods (4 $\mu$ s) 10 = 16 clock periods (8 $\mu$ s) 11 = 32 clock periods (16 $\mu$ s)
10	AVG0	R/W	LSB of ADC averaging code
11	AVG1	R/W	MSB of ADC averaging code 00 = no averaging (1 conversion per channel) 01 = 4 measurements per channel averaged 10 = 8 measurements per channel averaged 11 = 16 measurements per channel averaged

**Register Name: Alert Status/Enable Register**

Write Address: 0011

Read Address: 00011

Default Value: 0x000

Type: Read/write

**Table 18.**

Bit	Name	Read/Write	Description
0	AUX1LO	R/W	When this bit is 1, the AUX1 channel is below its low limit
1	BAT1LO	R/W	When this bit is 1, the BAT1 channel is below its low limit
2	BAT2LO	R/W	When this bit is 1, the BAT2 channel is below its low limit
3	TEMP1LO	R/W	When this bit is 1, the TEMP1 channel is above its low limit
4	AUX1HI	R/W	When this bit is 1, the AUX1 channel is above its high limit
5	BAT1HI	R/W	When this bit is 1, the BAT1 channel is above its high limit
6	BAT2HI	R/W	When this bit is 1, the BAT2 channel is above its high limit
7	TEMP1HI	R/W	When this bit is 1, the TEMP1 channel is below its high limit
8	AUX1EN	R/W	Setting this bit enables AUX1 as an interrupt source to the $\overline{\text{ALERT}}$ output
9	BAT1EN	R/W	Setting this bit enables BAT1 as an interrupt source to the $\overline{\text{ALERT}}$ output
10	BAT2EN	R/W	Setting this bit enables BAT2 as an interrupt source to the $\overline{\text{ALERT}}$ output
11	TEMP1EN	R/W	Setting this bit enables TEMP1 as an interrupt source to the $\overline{\text{ALERT}}$ output

**Register Name: AUX1 High Limit**

Write Address: 0100

Read Address: 00100

Default Value: 0x000

Type: Read/write

This register contains the 12-bit high limit for Auxiliary Input 1.

**Register Name: AUX1 Low Limit**

Write Address: 0101

Read Address: 00101

Default Value: 0x000

Type: Read/write

This register contains the 12-bit low limit for Auxiliary Input 1.

**Register Name: BAT1 High Limit**

Write Address: 0110

Read Address: 00110

Default Value: 0x000

Type: Read/write

This register contains the 12-bit high limit for Battery Monitoring Input 1.

**Register Name: BAT1 Low Limit**

Write Address: 0111

Read Address: 00111

Default Value: 0x000

Type: Read/write

This register contains the 12-bit low limit for Battery Monitoring Input 1.

**Register Name: BAT2 High Limit**

Write Address: 1000

Read Address: 01000

Default Value: 0x000

Type: Read/write

This register contains the 12-bit high limit for Battery Monitoring Input 2.

# AD7877

**Register Name: BAT2 Low Limit**

Write Address: 1001

Read Address: 01001

Default Value: 0x000

Type: Read/write

This register contains the 12-bit low limit for Battery Monitoring Input 2.

**Register Name: TEMP1 Low Limit**

Write Address: 1010

Read Address: 01010

Default Value: 0x000

Type: Read/write

This register contains the 12-bit low limit for temperature measurement.

**Register Name: TEMP1 High Limit**

Write Address: 1011

Read Address: 01011

Default Value: 0x000

Type: Read/write

This register contains the 12-bit high limit for temperature measurement.

**Register Name: Sequencer Register 0**

Write Address: 1100

Read Address: 01100

Default Value: 0x000

Type: Read/write

**Table 19.**

Bit	Name	Read/Write	Description
0	Not Used	R/W	This bit is not used
1	Z1_SS	R/W	Setting this bit includes the Z1 touch-pressure measurement (X+ input) in a slave mode sequence
2	TEMP2_SS	R/W	Setting this bit includes a temperature measurement using differential conversion in a slave mode sequence
3	TEMP1_SS	R/W	Setting this bit includes a temperature measurement using single-ended conversion in a slave mode sequence
4	BAT2_SS	R/W	Setting this bit includes measurement of Battery Monitor Input 2 in a slave mode sequence
5	BAT1_SS	R/W	Setting this bit includes measurement of Battery Monitor Input 1 in a slave mode sequence
6	AUX3_SS	R/W	Setting this bit includes measurement of Auxiliary Input 3 in a slave mode sequence
7	AUX2_SS	R/W	Setting this bit includes measurement of Auxiliary Input 2 in a slave mode sequence
8	AUX1_SS	R/W	Setting this bit includes measurement of Auxiliary Input 1 in a slave mode sequence
9	Z2_SS	R/W	Setting this bit includes the Z2 touch-pressure measurement (Y- input) in a slave mode sequence
10	XPOS_SS	R/W	Setting this bit includes measurement of the X position (Y+ input) in a slave mode sequence
11	YPOS_SS	R/W	Setting this bit includes measurement of the Y position (X+ input) in a slave mode sequence

**Register Name: Sequencer Register 1**

Write Address: 1101

Read Address: 01101

Default Value: 0x000

Type: Read/write

**Table 20.**

Bit	Name	Read/Write	Description
0	Not Used	R/W	This bit is not used
1	Z1_MS	R/W	Setting this bit includes the Z1 touch-pressure measurement (X+ input) in a master mode sequence
2	TEMP2_MS	R/W	Setting this bit includes a temperature measurement using differential conversion in a master mode sequence
3	TEMP1_MS	R/W	Setting this bit includes a temperature measurement using single-ended conversion in a master mode sequence
4	BAT2_MS	R/W	Setting this bit includes measurement of Battery Monitor Input 2 in a master mode sequence
5	BAT1_MS	R/W	Setting this bit includes measurement of Battery Monitor Input 1 in a master mode sequence
6	AUX3_MS	R/W	Setting this bit includes measurement of Auxiliary Input 3 in a master mode sequence
7	AUX2_MS	R/W	Setting this bit includes measurement of Auxiliary Input 2 in a master mode sequence
8	AUX1_MS	R/W	Setting this bit includes measurement of Auxiliary Input 1 in a master mode sequence
9	Z2_MS	R/W	Setting this bit includes the Z2 touch-pressure measurement (Y- input) in a master mode sequence
10	XPOS_MS	R/W	Setting this bit includes measurement of the X position (Y+ input) in a master mode sequence
11	YPOS_MS	R/W	Setting this bit includes measurement of the Y position (X+ input) in a master mode sequence

# AD7877

## Register Name: DAC Register

Write Address: 1110

Read Address: 01110

Default Value: 0x008

Type: Read/write

**Table 21.**

Bit	Name	Read/Write	Description
0	RANGE	R/W	Output range of the DAC in voltage mode 0 = 0 to $V_{CC}/2$ 1 = 0 to $V_{CC}$
1	Not Used	R/W	This bit is not used
2	V/I	R/W	Voltage output and current output 0 = voltage 1 = current
3	PD	R/W	DAC power-down 0 = DAC on 1 = DAC powered down
4	DAC0		LSB of DAC data
5	DAC1		Bit 1 of DAC data
6	DAC2		Bit 2 of DAC data
7	DAC3		Bit 3 of DAC data
8	DAC4		Bit 4 of DAC data
9	DAC5		Bit 5 of DAC data
10	DAC6		Bit 6 of DAC data
11	DAC7		MSB of DAC data

## Register Name: Y Position

Write Address: N/A

Read Address: 10000

Default Value: 0x000

Type: Read only

This register contains the 12-bit result of the measurement at the X+ input with Y layer excited (Y position measurement).

## Register Name: X Position

Write Address: N/A

Read Address: 10001

Default Value: 0x000

Type: Read only

This register contains the 12-bit result of the measurement at the Y+ input with X layer excited (X position measurement).

## Register Name: Z2

Write Address: N/A

Read Address: 10010

Default Value: 0x000

Type: Read only

This register contains the 12-bit result of the measurement at the Y- input with excitation voltage applied to Y+ and X- (used for touch-pressure calculation).

## Register Name: AUX1

Write Address: N/A

Read Address: 10011

Default Value: 0x000

Type: Read only

This register contains the 12-bit result of the measurement at Auxiliary Input 1.

**Register Name: AUX2**

Write Address: N/A

Read Address: 10100

Default Value: 0x000

Type: Read only

This register contains the 12-bit result of the measurement at Auxiliary Input 2.

**Register Name: AUX3**

Write Address: N/A

Read Address: 10101

Default Value: 0x000

Type: Read only

This register contains the 12-bit result of the measurement at Auxiliary Input 3.

**Register Name: BAT1**

Write Address: N/A

Read Address: 10110

Default Value: 0x000

Type: Read only

This register contains the 12-bit result of the measurement at Battery Monitor Input 1.

**Register Name: BAT2**

Write Address: N/A

Read Address: 10111

Default Value: 0x000

Type: Read only

This register contains the 12-bit result of the measurement at Battery Monitor Input 2.

**Register Name: TEMP1**

Write Address: N/A

Read Address: 11000

Default Value: 0x000

Type: Read only

This register contains the 12-bit result of a temperature measurement using single-ended conversion.

**Register Name: TEMP2**

Write Address: N/A

Read Address: 11001

Default Value: 0x000

Type: Read only

This register contains the 12-bit result of a temperature measurement using a differential conversion.

**Register Name: Z1**

Write Address: N/A

Read Address: 11010

Default Value: 0x000

Type: Read only

This register contains the 12-bit result of a measurement at the X+ input with excitation voltage applied to Y+ and X- (used for touch-pressure calculation).

**GPIO REGISTERS**

GPIO registers are written to using an extended 8-bit address. The first four bits of the data-word are always 1111b to access the extended writing map. The next four bits are the register address. This leaves 8 bits for the GPIO data.

GPIO registers are read like all other registers, by writing a 5-bit address to Control Register 1, then reading DOUT.

See the GPIO Configuration section for information on configuring the GPIOs.

**Register Name: GPIO Control Register 1**

Write Address: [1111] 0000

Read Address: 11011

Default Value: 0x000

Type: Read/write

**Table 22.**

Bit	Name	Read/Write	Description
0	GPIO2_ALEN	R/W	If this bit is 1, GPIO2 is an interrupt source for the $\overline{\text{ALERT}}$ output; clearing this bit masks out GPIO2 as an interrupt source for the $\overline{\text{ALERT}}$ output
1	GPIO2_DIR	R/W	This bit sets the direction of GPIO2 0 = output 1 = input
2	GPIO2_POL	R/W	This bit determines if GPIO2 is active high or low 0 = active low 1 = active high
3	GPIO2_EN	R/W	This bit selects the function of AUX2/GPIO2 0 = AUX2 1 = GPIO2
4	GPIO1_ALEN	R/W	If this bit is 1, GPIO1 is an interrupt source for the $\overline{\text{ALERT}}$ output; clearing this bit masks out GPIO1 as an interrupt source for the $\overline{\text{ALERT}}$ output
5	GPIO1_DIR	R/W	This bit sets the direction of GPIO1 0 = output 1 = input
6	GPIO1_POL	R/W	This bit determines if GPIO1 is active high or low 0 = active low 1 = active high
7	GPIO1_EN	R/W	This bit selects the function of AUX1/GPIO1 0 = AUX1 1 = GPIO1

**Register Name: GPIO Control Register 2**

Write Address: [1111] 0001

Read Address: 11100

Default Value: 0x000

Type: Read/write

**Table 23.**

Bit	Name	Read/Write	Description
0	GPIO4_ALEN	R/W	If this bit is 1, GPIO4 is an interrupt source for the $\overline{\text{ALERT}}$ output; clearing this bit masks out GPIO3 as an interrupt source for the $\overline{\text{ALERT}}$ output
1	GPIO4_DIR	R/W	This bit sets the direction of GPIO4 0 = output 1 = input
2	GPIO4_POL	R/W	This bit determines if GPIO4 is active high or low 0 = active low 1 = active high
3	Not Used		This bit is not used
4	GPIO3_ALEN	R/W	If this bit is 1, GPIO3 is an interrupt source for the $\overline{\text{ALERT}}$ output; clearing this bit masks out GPIO4 as an interrupt source for the $\overline{\text{ALERT}}$ output
5	GPIO3_DIR	R/W	This bit sets the direction of GPIO3 0 = output 1 = input
6	GPIO3_POL	R/W	This bit determines if GPIO3 is active high or low 0 = active low 1 = active high
7	GPIO3_EN	R/W	This bit selects the function of AUX3/GPIO3 0 = AUX3 1 = GPIO3

**Register Name: GPIO Data Register**

Write Address: [1111] 0010

Read Address: 11101

Default Value: 0x000

Type: Read/write

**Table 24.**

Bit	Name	Read/Write	Description
0	Not used		This bit is not used
1	Not used		This bit is not used
2	Not used		This bit is not used
3	Not used		This bit is not used
4	GPIO4_DAT	R/W	GPIO4 data bit
5	GPIO3_DAT	R/W	GPIO3 data bit
6	GPIO2_DAT	R/W	GPIO2 data bit
7	GPIO1_DAT	R/W	GPIO1 data bit

