

Evaluating the **ADN4612**, 11.3 Gbps, 12 × 12 Digital Crosspoint Switch

FEATURES

Full featured evaluation board for the **ADN4612**
USB to I²C control interface
On-board power distribution network

EVALUATION KIT CONTENTS

ADN4612 evaluation board
USB cable
DC-to-DC converter power cable

DOCUMENTS NEEDED

ADN4612 data sheet
ADN4612-EVALZ user guide
ADN4612 evaluation board schematic

SOFTWARE NEEDED

ADN4612 evaluation software

EQUIPMENT NEEDED

A differential oscilloscope or serial data analyzer with
greater than 12 GHz analog input bandwidth
A differential pattern generator
A PC with Windows® 2000/XP

GENERAL DESCRIPTION

The **ADN4612** evaluation board user guide describes the setup and general usage of the **ADN4612** evaluation board. Included in this document is a quick start guide, hardware configuration instructions, and software installation instructions.

The **ADN4612** evaluation board provides access to all 12 differential input ports and 12 differential output ports of the **ADN4612** via top launch SMA connectors. Each input and output pair is ac-coupled using a 0.1 μ F capacitor.

EVALUATION BOARD CONNECTION DIAGRAM

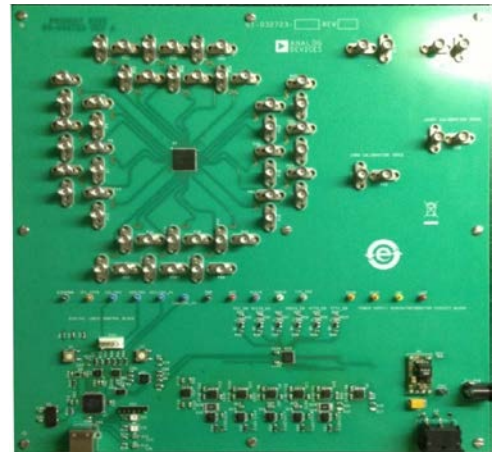

Figure 1. **ADN4612** Evaluation Board

All microstrip (top layer) transmission lines use an RoHs compliant, Megtron-6 dielectric. The differential transmission line pairs are 10 mil wide with 7.5 mil spacing and are designed to have a differential characteristic impedance of 100 Ω . The stripline (middle layers) transmission lines are RoHs compliant, FR-4 material.

TABLE OF CONTENTS

Features	1	Input Signals.....	4
Evaluation Kit Contents.....	1	Output Signals	4
Documents Needed.....	1	USB to I ² C MCU	5
Software Needed.....	1	Switches	5
Equipment Needed.....	1	Evaluation Board Software.....	6
Evaluation Board Connection Diagram.....	1	Software Overview	6
General Description	1	Load from EEPROM Procedure.....	9
Revision History	2	Evaluation Board Schematics and Artwork.....	10
Quick Start Guide.....	3	Ordering Information.....	13
Evaluation Board Hardware.....	4	Bill of Materials.....	13
Power Supplies	4		

REVISION HISTORY

10/15—Revision 0: Initial Version

QUICK START GUIDE

This section provides a quick start procedure for using the [ADN4612](#) on the evaluation board. The following procedure describes how to set the default settings:

1. Insert the 12 V adapter terminal into connector P58.
2. Set the power switch (S3) to the on position.
3. Connect the provided USB cable from the PC to the USB connector on the evaluation board (P56).
4. Connect IPx (positive) and INx (negative) to a pattern generator to receive a pseudorandom binary sequence (PRBS) signal. It is important to use a pair of matched length, 50 Ω cables.
5. Connect OPx and ONx to an oscilloscope using a pair of matched length, 50 Ω cables.
6. Apply a data pattern signal (any rate up to 11.3 Gbps) to the [ADN4612](#). A signal with an amplitude of 800 mV p-p differential is a good signal for an initial test.
7. Extract the contents of the compressed [ADN4612 Evaluation Software](#) .zip file to a folder on the PC.
8. Double-click [ADN4612_0vX.exe](#) to run the [ADN4612](#) evaluation software.
9. Use the software provided to control the [ADN4612](#). Refer to the Software Overview section for details on how to configure a channel for evaluation.

The graphical user interface (GUI) resets the device and sets the receiver, crosspoint switch core, and transmitter to a default configuration. The user can click the **RESET DEVICE** button to ensure that the [ADN4612](#) is in the correct default state and matches the user interface. The reset operation may take several seconds to complete and can be monitored via the progress bar.

EVALUATION BOARD HARDWARE

POWER SUPPLIES

The [ADN4612](#) consists of core, input/output, and digital logic supplies. All supplies are referenced to VEE (typically 0 V). The evaluation board supply voltages are listed in Table 1.

A 12 V/5 A (60 Hz) power adapter (provided with the evaluation kit) supplies power to the [ADN4612](#) evaluation board. An on/off switch enables or disables power to the board. A switch regulator provides 12 V to 5 V dc-to-dc conversion. Analog Devices, Inc., linear dropout regulators generate the correct VCC25, VCC18, VDD18, VTTI, and VTTO supply voltages for the [ADN4612](#).

INPUT SIGNALS

High Speed Differential Serial Inputs (INx/IPx)

The [ADN4612](#) receives a differential or single-ended signal through the top launch, screw-fit SMA connectors (Molex, Model 73251-1851), labeled INx and IPx

The SMA connectors can move to any connector placement location on the evaluation board. A differential input signal level of 800 mV p-p differential is suggested for initial investigation.

With ac signal coupling, [ADN4612](#) supports not only current mode logic (CML), but also low voltage differential signaling (LVDS) and low voltage positive referenced emitter coupler logic (LVPECL). Ceramic capacitors provide the ac coupling path to the signal input. To match with the 50 Ω transmission line, the [ADN4612](#) has on-chip, 50 Ω termination resistors at the input pads.

OUTPUT SIGNALS

High Speed Differential Serial Outputs (OPx/ONx)

The CML outputs are ac-coupled to the SMA connectors, labeled OPx and ONx, through ceramic capacitors.

Table 1. [ADN4612](#) Supply Voltages

Supply Mnemonic	Type	Voltage (V)	Test Points
VCC	Core analog	2.5	VCC (red)
VCC1P8	Core analog	1.8	VCC18 (purple)
VTTIW/VTTIE	Input termination	2.5	VTTI (orange)
VTTON/VTTO	Output termination	3.3	VTTO (orange)
DVCC	Digital logic	1.8	VDD18 (white)



Figure 2. [ADN4612](#) Evaluation Board Power Distribution Network

USB TO I²C MCU

The PIC microcontroller unit (MCU)-based USB device communication circuit allows device register read or write communication through an I²C bus interface (see Figure 3).

SWITCHES

Table 2 lists the manual push-button switches available on the ADN4612 evaluation board and the function each switch controls.

Table 2. ADN4612 Switches

Switch	Function
S1	ADN4612 RESET
S2	PIC microcontroller reset
S3	Power supply on/off switch

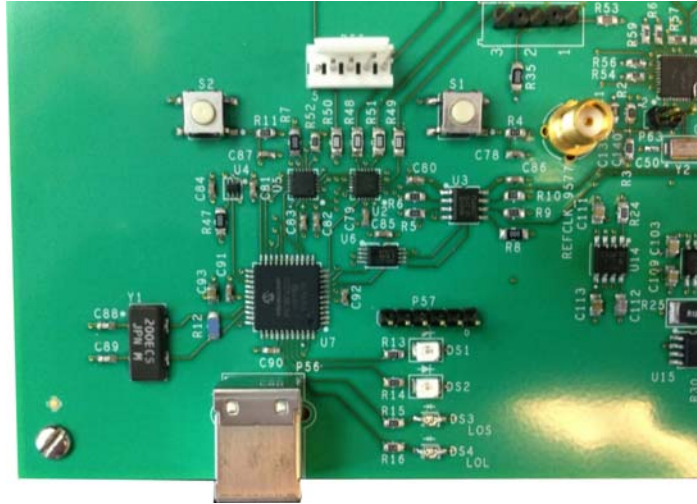

Figure 3. ADN4612 Evaluation Board USB to I²C PIC MCU

13248-003

EVALUATION BOARD SOFTWARE

SOFTWARE OVERVIEW

The software requires the hsiUsb.dll file to establish successful communication with the device. The file is located in the same folder as the ADN4612_0vX.exe executable.

Some operating systems require placing the hsiUsb.dll file into the folder above the ADN4612_0vX.exe file to operate the software.

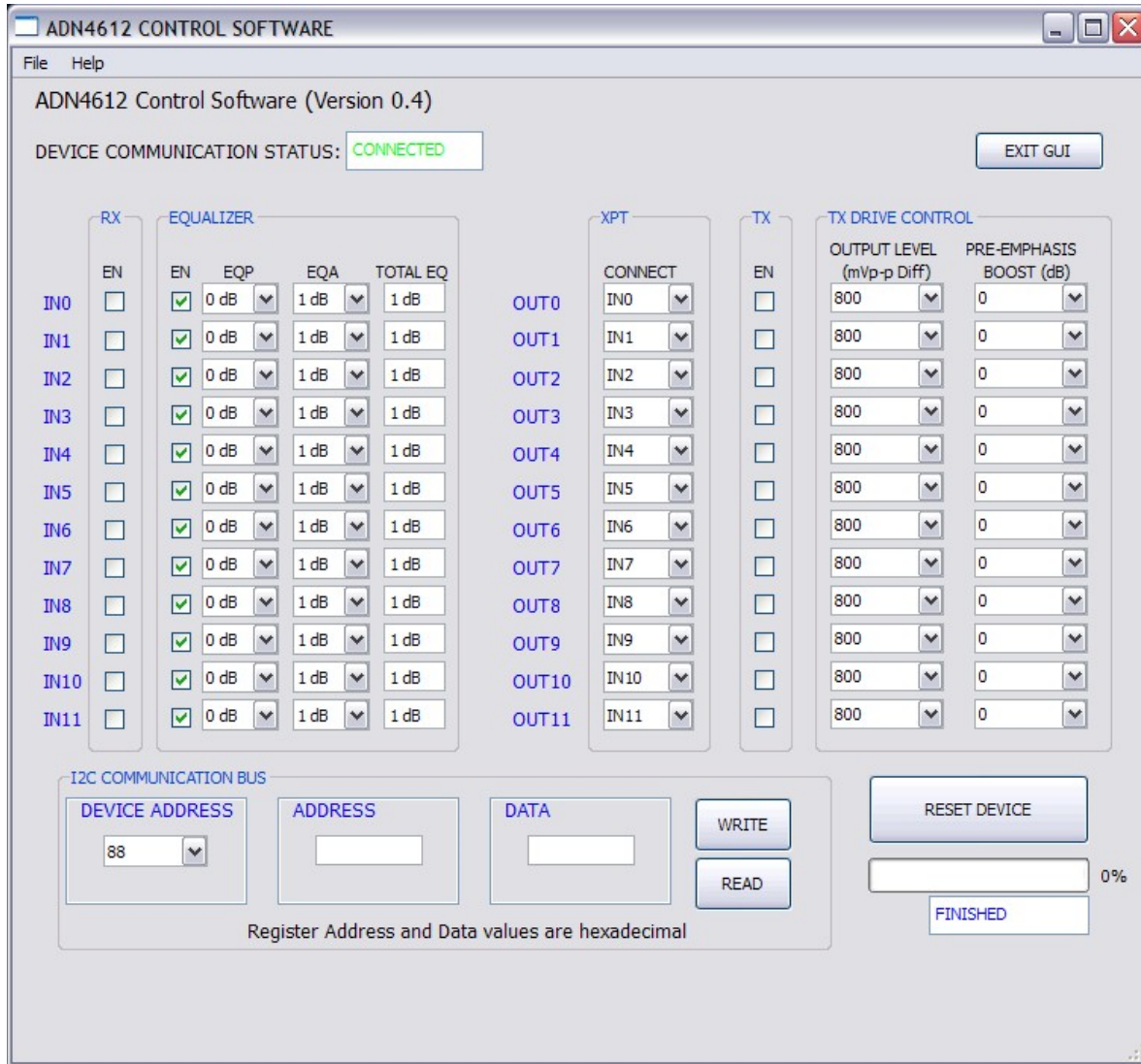

Figure 4. ADN4612 Control Software Screenshot

Input Controls**RX EN**

Select the **EN** check boxes to enable or disable the inputs. By default, **RX EN** is disabled.

EQUALIZER EN

Select the **EN** check boxes to enable or disable the equalizer. By default, **EQUALIZER EN** is enabled.

EQUALIZER EQP, EQA, and TOTAL EQ

Select the values, in decibels, from the drop-down menus for an **EQP** (default: 0 dB) and **EQA** (default: 1 dB) boost. The **TOTAL EQ** boxes summarize the total equalizer boost setting in decibels (default: 1 dB).

XPT Connect Control**XPT CONNECT**

Each output connects to any input. Choose which input connects to the corresponding output from the drop-down menus. The crosspoint connection state automatically updates upon selection. (By default, INx connects to OUTx.)

Output Controls**TX EN**

Select the check boxes to enable or disable the outputs. By default, **TX EN** is disabled.

TX DRIVE CONTROL OUTPUT LEVEL (mV p-p Diff)

Click the drop-down menus and select an mV p-p differential value to set the dc output level swing. The default of the **TX DRIVE CONTROL OUTPUT LEVEL** box is 800 mV p-p differential.

TX DRIVE CONTROL PRE-EMPHASIS BOOST (dB)

Select the decibel value in the drop-down menus to set the output pre-emphasis boost. The maximum available pre-emphasis boost decibel varies with the **OUTPUT LEVEL (mVp-p Diff)** setting. The **VTTO** supply must be set to 3.3 V for all pre-emphasis settings to work properly.

I²C Communication Bus Controls**DEVICE ADDRESS**

The **DEVICE ADDRESS** drop-down menu selects the I²C device address. The device address must match the corresponding switch settings on the evaluation board (S2, S3). The value is listed in hexadecimal format. The allowable values are 0x88, 0x8A, 0x8C, and 0x8E.

ADDRESS

The **ADDRESS** box is the register address field. Values are hexadecimal and only values 00 to FF are valid; the register address field does not recognize 0x as a valid value.

DATA

The **DATA** field is the register data field. Values are hexadecimal. The 0x prefix is not recognized during an I²C write operation; valid values are 00 to FF. The result of a register read command overwrites the text in this field and contains the 0x prefix. If a register command is unsuccessful, the text “-0x3” appears in the field. The **DEVICE COMMUNICATION STATUS** box indicates if the software is successfully communicating to the [ADN4612](#).

WRITE Button

The **WRITE** button initiates a single I²C register write command using the device address, register address, and data values.

READ Button

The **READ** button initiates a single I²C register read command using the device address and register address values. The I²C read result is written to the **DATA** field. The result of a register read command overwrites the text in this box and contains the 0x prefix.

Device Communication Status

The **DEVICE COMMUNICATION STATUS** box indicates if the software is successfully communicating with the [ADN4612](#). The value **CONNECTED** indicates successful communication. The value **DISCONNECTED** indicates unsuccessful communication.

Possible device communication problems include

- The USB cable detached from the I²C interface board or PC.
- The I²C interface board detached from the [ADN4612](#) evaluation board.

Reset Control

The **RESET DEVICE** button initiates a software reset of the [ADN4612](#), initializes the [ADN4612](#) to the recommended default settings, and restores the GUI to the default state. Click **RESET DEVICE** after a power-up or a hardware reset to ensure that the [ADN4612](#) is in the correct default state. It can take several seconds for the reset operation to complete. The progress bar indicates when the reset operation is complete.

Exit Control

The **EXIT GUI** button exits the software program.

Script Control**Export Register File**

The export register file exports the register content of the [ADN4612](#) register map into a text file. By default, the text file is written to the ADN4612_v1.0 folder. The user can modify the default directory. The progress bar indicates when the export operation completes. The text file is written as register address, register data; for example, the file can be written as 0x01.

Import Register File

The import register file imports the register content of the [ADN4612](#) register map from a text file. The function restores the GUI to the register settings in the import file. The progress bar indicates when the import operation completes. The text file must be written as register address, register data to import correctly into the GUI.

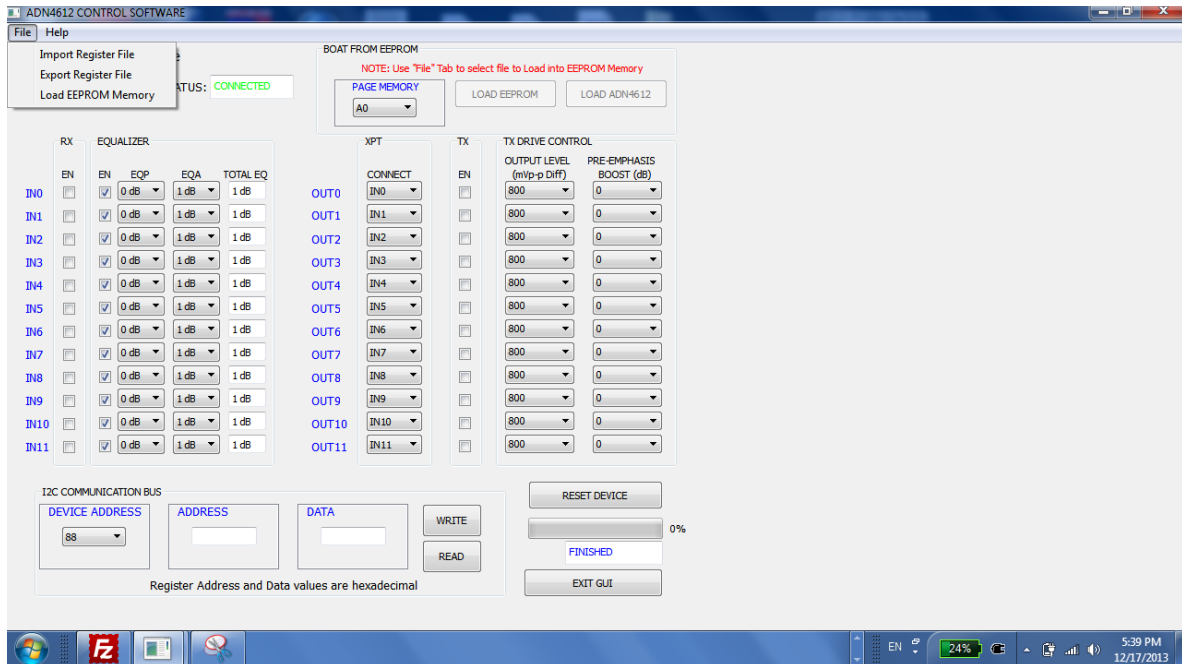

Figure 5. Load EEPROM Memory Control Software Screenshot

LOAD FROM EEPROM PROCEDURE

To enable the power-on ready operation and alleviate system control overhead, the **ADN4612** can optionally load the configuration from an external serial EEPROM. All user registers, except for read only registers, can automatically load using the I²C bus. The **ADN4612** evaluation board hardware and software supports the load from EEPROM feature. The following steps provide instructions on how to utilize this feature:

1. Click File > **Load EEPROM Memory**.
2. Select the **EEPROM file** to load into the EEPROM memory. See examples of how to construct the user generated EEPROM file in Table 3.
3. The **Load EEPROM** button is enabled after the file is read into the tool. The EEPROM file format is a text file.
4. Select one of the following locations from the **Page Memory** drop-down menu:
 - A0 = Page 00
 - A2 = Page 01
 - A4 = Page 10
 - A6 = Page 11
5. Click **LOAD EEPROM** to load the EEPROM memory.

6. The **LOAD ADN4612** button is enabled after the load is complete.
7. Click the **Device Address** drop-down menu to select the device address value that maps to the EEPROM page memory. Choose one of the following maps:
 - 88 = A0
 - 8A = A2
 - 8C = A4
 - 8E = A6
8. Click **LOAD ADN4612** to configure the **ADN4612** registers from the EEPROM memory.
9. The GUI reflects the status of the **ADN4612** registers.

Table 3. Examples of the EEPROM File

Address	Data
0	0
1	13
2	FF
3	0F
4	3F
...	...
225	BC

EVALUATION BOARD SCHEMATICS AND ARTWORK

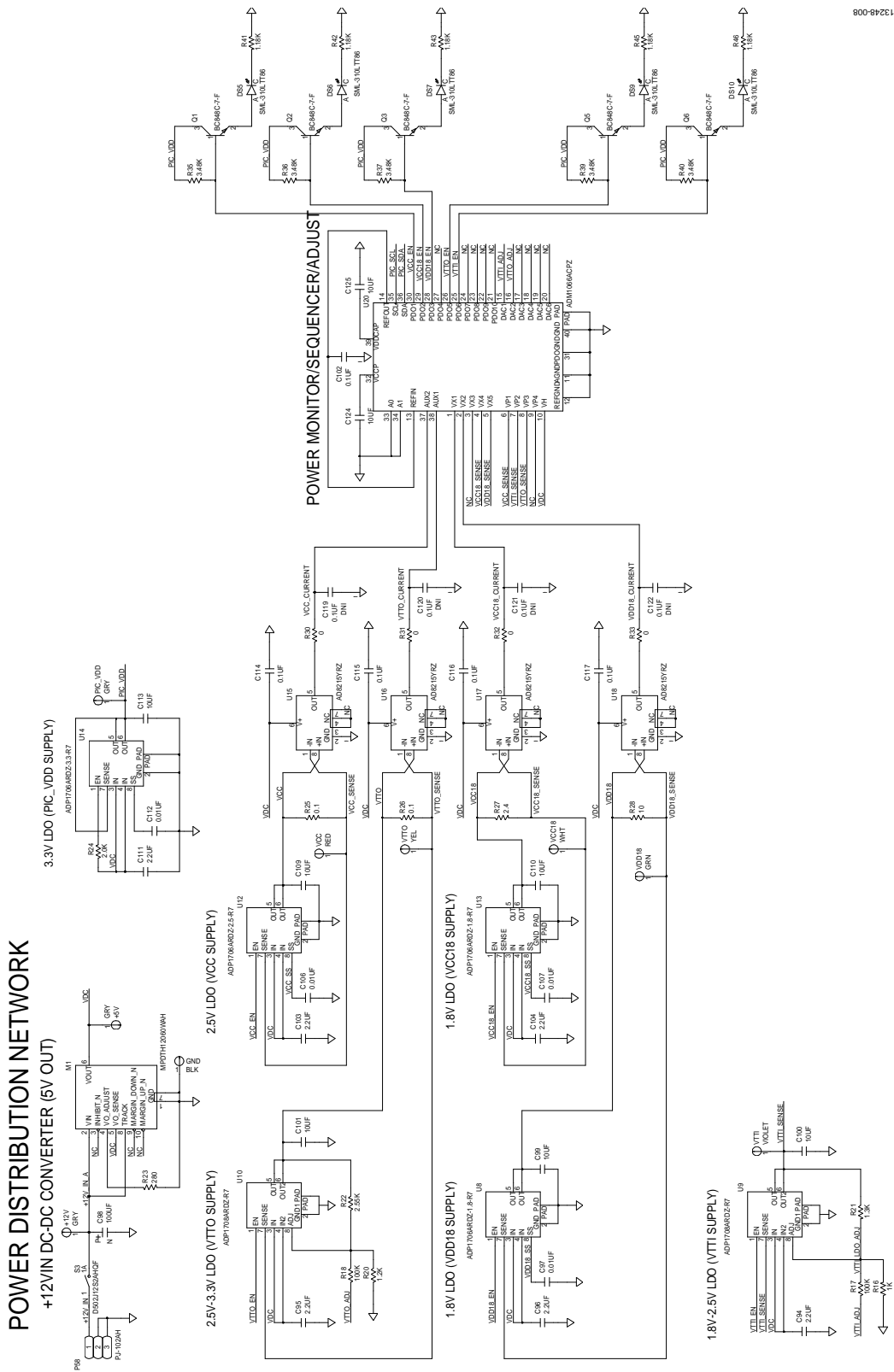

13246-008

Figure 6. ADN4612 Evaluation Board Power Distribution Network Schematic

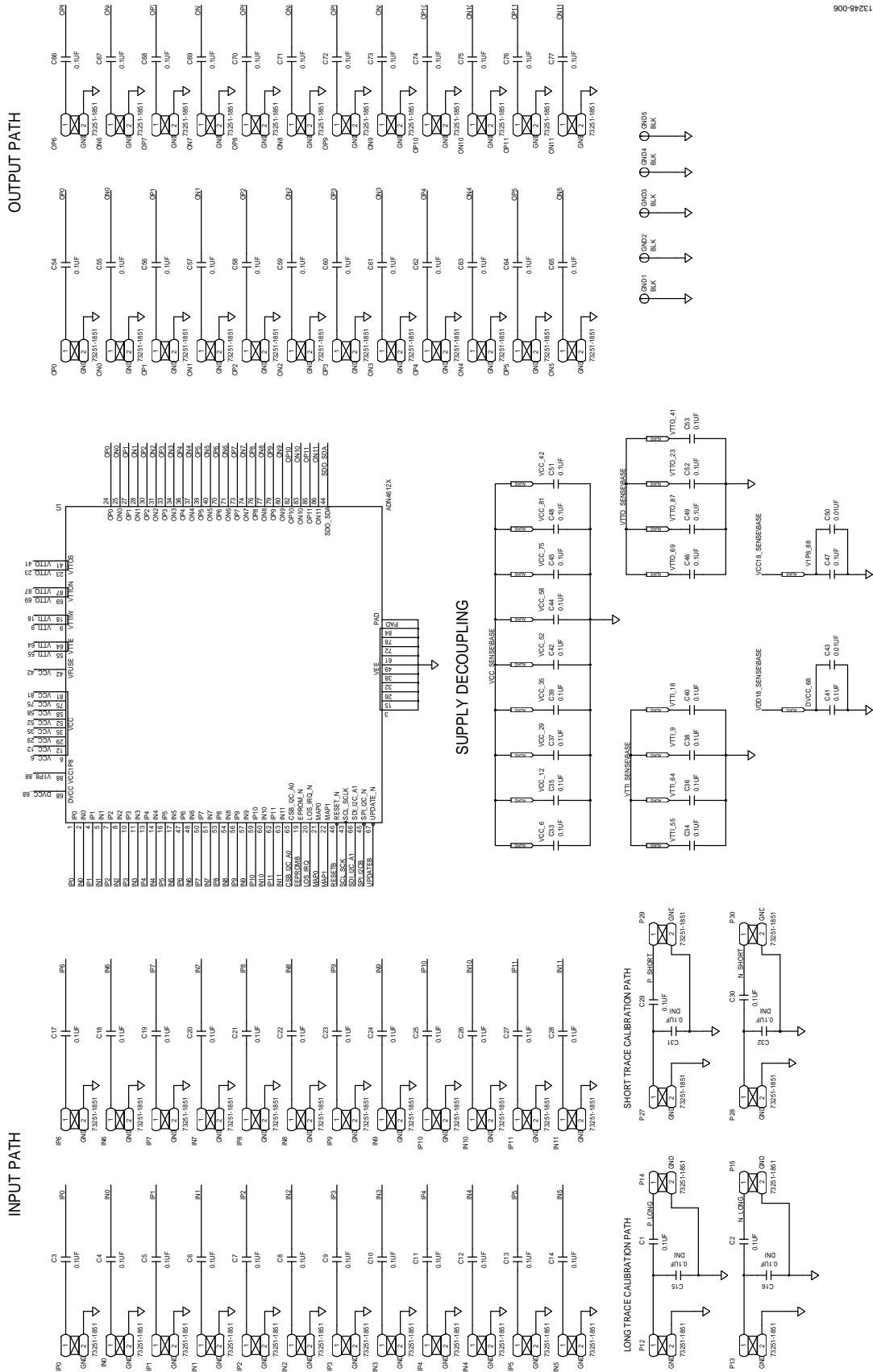

Figure 7. ADN4612 Design Schematic

13246-007

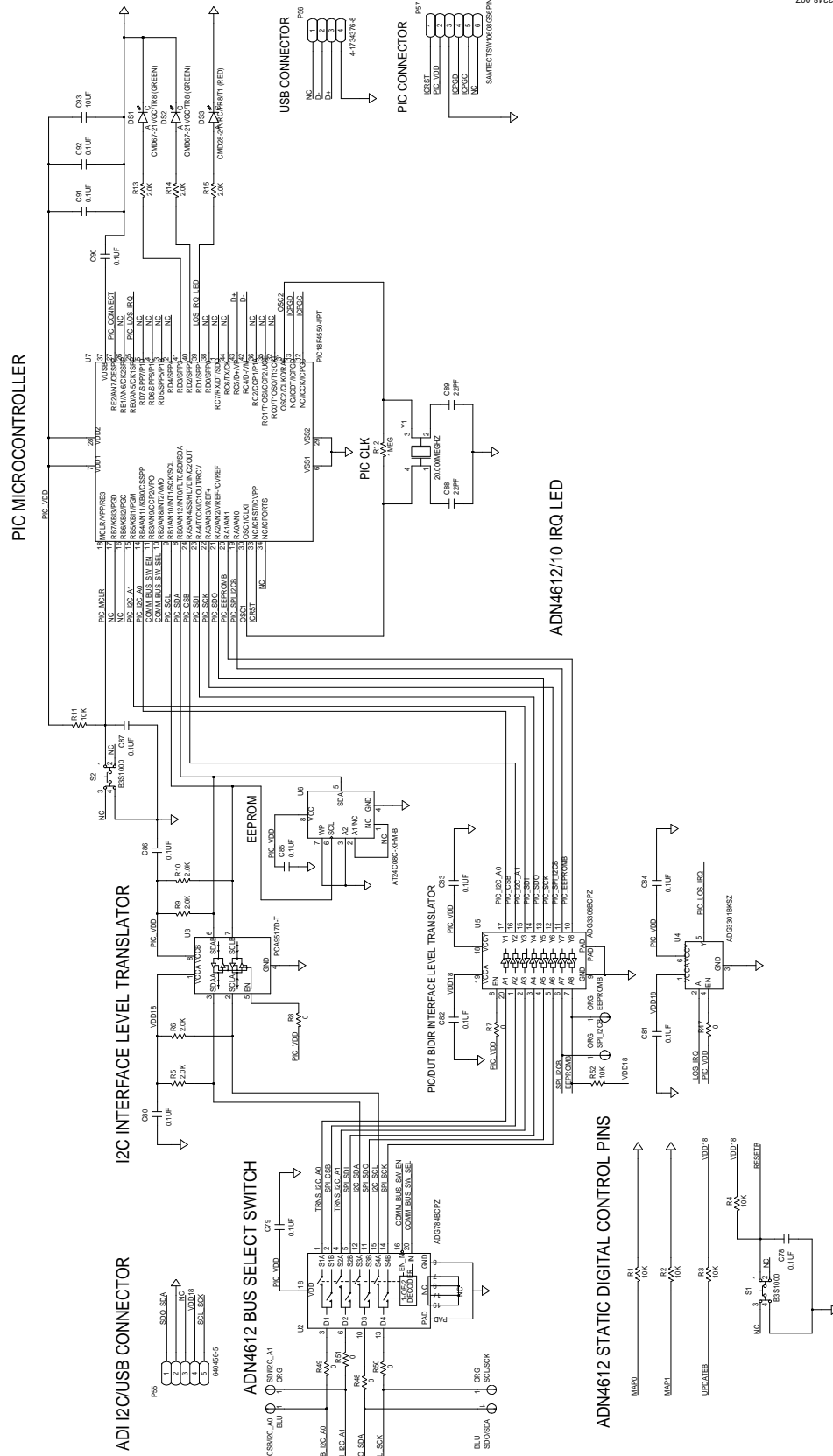

Figure 8. ADN4612 Evaluation Board Digital Control Block Schematic

ORDERING INFORMATION

BILL OF MATERIALS

Table 4.

Item	Qty	Reference Designator	Description	Manufacturer	Part Number
1	1	ADN4612-EVALZ	Printed circuit board	Analog Devices	ADN4612-EVALZ
2	3	+5 V, +12 V, PIC_VDD	Connector-PCB, test points, grey	Components Corporation	TP104-01-08
3	52	C1 to C14, C17 to C30, C54 to C77	Capacitors, ceramic, X5R	Murata	GRM033R61C104ME84D
4	9	C93, C99 to C101, C109, C110, C113, C124, C125	Capacitors, ceramic, monolithic	Murata	GRM21BR61C106KE15L
5	18	C78 to C87, C90 to C92, C102, C114 to C117	Capacitors, ceramic chip, X8R	TDK	C1608X8R1E104K
6	6	C94 C96, C103, C104, C111	Capacitors, ceramic, monolithic	Murata	GRM21BR71E225KA73L
7	6	C43, C50, C97, C106, C107, C112	Capacitors, ceramic, monolithic, C0G, 0805	Murata	GRM2195C1H103JA01D
8	19	C33 to C42, C44 to C49, C51 to C53	Capacitors, ceramic, X7R, 0402	Murata	GRM155R71C104KA88D
9	2	C88, C89	Capacitors, ceramic, NP0	Phycomp (Yageo)	CC0603JRN09BN220
10	1	C98	Capacitor, tantalum	AVX	TAJE107M025RNJ
11	2	SDO/SDA, CSB/I2C_A0	Connector-PCB, test points, blue	Components Corporation	TP104-01-06
12	2	DS1, DS2	Diodes, SMD, LED	Chicago Miniature Lamp	CMD67-21VGC/TR8
13	5	DS5 to DS7, DS9, DS10	Red LED surface mounts	Rohm	SML-310LTT86
14	1	DS3	Diode, red LED, SMD	Chicago Miniature Lamp	CMD28-21VRC/TR8/T1
15	4	EEPROMB, SCL/SCK, SPI_I2CB, SDI/I2C_A1	Connector-PCB, test points, orange	Components Corporation	TP104-01-03
16	6	GND, GND1 to GND5	Connector-PCB, test points, black	Components Corporation	TP-104-01-00
17	56	IN0 to IN11, IP0 to IP11, ON0 to ON11, OP0 to OP11, P12 to P15, P27 to P30	Connector-PCB, SMA jacks, panel mount flange	Molex	73251-1851
18	1	M1	Module dc-to-dc conversion application manual	Murata	MPDTH12060WAH
19	1	P55	Connector-PCB, header, vertical, 5 position	AMP	640456-5
20	1	P56	Connector-PCB, USB, type B, right angle through hole	AMP	4-1734376-8
21	1	P57	Connector-PCB, header, male, 6P	Samtec	TSW-106-08-G-S
22	1	P58	Connector-PCB, dc power jack, through-hole	CUI	PJ-102AH
23	5	Q1 to Q3, Q5, Q6	Transition, surface-mount signal	Diodes Incorporated	BC848C-7-F
24	6	R1 to R4, R11, R52	Resistors, film, SMD, 0805	Panasonic	ERA-6YEB103V
25	8	R5, R6, R9, R10, R13 to R15, R24	Resistors, film, SMD, 0805	Panasonic	ERA-6YEB202V
26	1	R12	Resistor, thin film chip	IRC-TT Electronics	PFC-W1206LF-03-1004-B
27	1	R16	Resistor, film, SMD, 0805	Panasonic	ERA-6YEB102V
28	2	R17, R18	Resistors, precision thick film chip, R0805	Panasonic	ERJ-6ENF1003V
29	1	R20	Resistor, film, SMD, 0805	Panasonic	ERA-6YEB122V
30	1	R21	Resistor, precision thick film chip, R0805	Panasonic	ERJ-6ENF1301V
31	1	R22	Resistor, precision thick film chip, R1206	Panasonic	ERJ-8ENF2551V

Item	Qty	Reference Designator	Description	Manufacturer	Part Number
32	1	R23	Resistor, precision thick film chip, R1206	Panasonic	ERJ-8ENF2800V
33	2	R25, R26	Resistors, power metal strip, high temperature	Vishay	WSLT2512R1000FEA
34	1	R27	Resistor chip, SMD, 0805	SUSUMU	RL1220S-2R4-F
35	1	R28	Resistor, precision thick film chip, R1206	Panasonic	ERJ-8ENF10R0V
36	11	R7, R8, R30 to R33, R47 to R51	Resistors, high power, thick film chip	Vishay	CRCW12060000Z0EAHP
37	5	R35 to R37, R39, R40	Resistors, precision thick film chip, R0603	Panasonic	ERJ-3EKF3481V
38	5	R41 to R43, R45, R46	Resistors, precision thick film chip, R0603	Panasonic	ERJ-3EKF1181V
39	2	S1, S2	Switch surface-mount mechanical key switches	Omron	B3S1000
40	1	S3	Switch, single-pole, single throw power rocker	C&K	D502J12S2AHQF
41	1	U1	Analog Devices IC ADN4612	Analog Devices	ADN4612
42	2	U9, U10	Analog Devices IC, low dropout, CMOS, linear regulator	Analog Devices	ADP1708ARDZ-R7
43	1	U12	Analog Devices IC, low dropout, CMOS, linear regulator	Analog Devices	ADP1706ARDZ-2.5-R7
44	2	U8, U13	Analog Devices IC, low dropout, CMOS, linear regulator	Analog Devices	ADP1706ARDZ-1.8-R7
45	1	U14	Analog Devices IC, low dropout, CMOS, linear regulator	Analog Devices	ADP1706ARDZ-3.3-R7
46	4	U15 to U18	Analog Devices IC, high voltage, current shunt monitor	Analog Devices	AD8215YRZ
47	1	U2	Analog Devices IC, CMOS, 3 V/5 V, wide bandwidth, quad 2:1, multiplexer	Analog Devices	ADG784BCPZ
48	1	U20	Analog Devices IC, super sequencer with margining control and auxiliary ADC inputs	Analog Devices	ADM1066ACPZ
49	1	U3	IC-CMOS, I ² C, bus repeater	NXP Semiconductors	PCA9517D-T
50	1	U4	IC, single channel, bidirectional logic level translator	Analog Devices	ADG3301BKSZ
51	1	U5	Low voltage, 8-channel, bidirectional logic level translator	Analog Devices	ADG3308BCPZ
52	1	U6	IC EEPROM, 2-wire, serial	Atmel	AT24C08C-XHM-B
53	1	U7	IC-other, high performance USB microcontrollers	Microchip Technology	PIC18F4550-I/PT
54	1	VCC	Connector-PCB, test point, red	Components Corporation	TP-104-01-02
55	1	VCC18	Connector-PCB, test point, white	Components Corporation	TP-104-01-09
56	1	VDD18	Connector-PCB, test point, green	Components Corporation	TP104-01-05
57	1	VTTI	Connector-PCB, test point, violet	Components Corporation	TP104-01-07
58	1	VTTO	Connector-PCB, test point, yellow	Components Corporation	TP-104-01-04
59	1	Y1	IC crystal oscillator	ECS	ECS-200-20-18

NOTES

I²C refers to a communications protocol originally developed by Philips Semiconductors (now NXP Semiconductors).



ESD Caution

ESD (electrostatic discharge) sensitive device. Charged devices and circuit boards can discharge without detection. Although this product features patented or proprietary protection circuitry, damage may occur on devices subjected to high energy ESD. Therefore, proper ESD precautions should be taken to avoid performance degradation or loss of functionality.

Legal Terms and Conditions

By using the evaluation board discussed herein (together with any tools, components documentation or support materials, the "Evaluation Board"), you are agreeing to be bound by the terms and conditions set forth below ("Agreement") unless you have purchased the Evaluation Board, in which case the Analog Devices Standard Terms and Conditions of Sale shall govern. Do not use the Evaluation Board until you have read and agreed to the Agreement. Your use of the Evaluation Board shall signify your acceptance of the Agreement. This Agreement is made by and between you ("Customer") and Analog Devices, Inc. ("ADI"), with its principal place of business at One Technology Way, Norwood, MA 02062, USA. Subject to the terms and conditions of the Agreement, ADI hereby grants to Customer a free, limited, personal, temporary, non-exclusive, non-sublicensable, non-transferable license to use the Evaluation Board FOR EVALUATION PURPOSES ONLY. Customer understands and agrees that the Evaluation Board is provided for the sole and exclusive purpose referenced above, and agrees not to use the Evaluation Board for any other purpose. Furthermore, the license granted is expressly subject to the following additional limitations: Customer shall not (i) rent, lease, display, sell, transfer, assign, sublicense, or distribute the Evaluation Board; and (ii) permit any Third Party to access the Evaluation Board. As used herein, the term "Third Party" includes any entity other than ADI, Customer, their employees, affiliates and in-house consultants. The Evaluation Board is NOT sold to Customer; all rights not expressly granted herein, including ownership of the Evaluation Board, are reserved by ADI. CONFIDENTIALITY. This Agreement and the Evaluation Board shall all be considered the confidential and proprietary information of ADI. Customer may not disclose or transfer any portion of the Evaluation Board to any other party for any reason. Upon discontinuation of use of the Evaluation Board or termination of this Agreement, Customer agrees to promptly return the Evaluation Board to ADI. ADDITIONAL RESTRICTIONS. Customer may not disassemble, decompile or reverse engineer chips on the Evaluation Board. Customer shall inform ADI of any occurred damages or any modifications or alterations it makes to the Evaluation Board, including but not limited to soldering or any other activity that affects the material content of the Evaluation Board. Modifications to the Evaluation Board must comply with applicable law, including but not limited to the RoHS Directive. TERMINATION. ADI may terminate this Agreement at any time upon giving written notice to Customer. Customer agrees to return to ADI the Evaluation Board at that time. LIMITATION OF LIABILITY. THE EVALUATION BOARD PROVIDED HEREUNDER IS PROVIDED "AS IS" AND ADI MAKES NO WARRANTIES OR REPRESENTATIONS OF ANY KIND WITH RESPECT TO IT. ADI SPECIFICALLY DISCLAIMS ANY REPRESENTATIONS, ENDORSEMENTS, GUARANTEES, OR WARRANTIES, EXPRESS OR IMPLIED, RELATED TO THE EVALUATION BOARD INCLUDING, BUT NOT LIMITED TO, THE IMPLIED WARRANTY OF MERCHANTABILITY, TITLE, FITNESS FOR A PARTICULAR PURPOSE OR NON-INFRINGEMENT OF INTELLECTUAL PROPERTY RIGHTS. IN NO EVENT WILL ADI AND ITS LICENSORS BE LIABLE FOR ANY INCIDENTAL, SPECIAL, INDIRECT, OR CONSEQUENTIAL DAMAGES RESULTING FROM CUSTOMER'S POSSESSION OR USE OF THE EVALUATION BOARD, INCLUDING BUT NOT LIMITED TO LOST PROFITS, DELAY COSTS, LABOR COSTS OR LOSS OF GOODWILL. ADI'S TOTAL LIABILITY FROM ANY AND ALL CAUSES SHALL BE LIMITED TO THE AMOUNT OF ONE HUNDRED US DOLLARS (\$100.00). EXPORT. Customer agrees that it will not directly or indirectly export the Evaluation Board to another country, and that it will comply with all applicable United States federal laws and regulations relating to exports. GOVERNING LAW. This Agreement shall be governed by and construed in accordance with the substantive laws of the Commonwealth of Massachusetts (excluding conflict of law rules). Any legal action regarding this Agreement will be heard in the state or federal courts having jurisdiction in Suffolk County, Massachusetts, and Customer hereby submits to the personal jurisdiction and venue of such courts. The United Nations Convention on Contracts for the International Sale of Goods shall not apply to this Agreement and is expressly disclaimed.

©2015 Analog Devices, Inc. All rights reserved. Trademarks and registered trademarks are the property of their respective owners.
UG13248-0-10/15(0)



www.analog.com