

FEATURES

- Digitally/pin-programmable gain**
G = 1, 2, 4, 8, 16, 32, 64, or 128
- Specified from -55°C to +125°C**
50 nV/°C maximum input offset drift
10 ppm/°C maximum gain drift
- Excellent dc performance**
80 dB minimum CMR, G = 1
15 μV maximum input offset voltage
500 pA maximum bias current
0.7 μV p-p noise (0.1 Hz to 10 Hz)
- Good ac performance**
2.7 MHz bandwidth, G = 1
1.1 V/μs slew rate
- Rail-to-rail output**
- Shutdown/multiplex**
- Extra op amp**
- Single-supply range: 3 V to 6 V**
- Dual-supply range: ±1.5 V to ±3 V**

ENHANCED PRODUCT FEATURES

- Supports defense and aerospace applications (AQEC standard)**
- Military temperature range (-55°C to +125°C)**
- Controlled manufacturing baseline**
- One assembly/test site**
- One fabrication site**
- Enhanced product change notification**
- Qualification data available on request**

GENERAL DESCRIPTION

The AD8231-EP is a low drift, rail-to-rail, instrumentation amplifier with software-programmable gains of 1, 2, 4, 8, 16, 32, 64, or 128. The gains are programmed via digital logic or pin strapping.

The AD8231-EP is ideal for applications that require precision performance over a wide temperature range, such as industrial temperature sensing and data logging. Because the gain setting resistors are internal, maximum gain drift is only 10 ppm/°C for gains of 1 to 32. Because of the auto-zero input stage, maximum input offset is 15 μV and maximum input offset drift is just 50 nV/°C. CMRR is 80 dB for G = 1, increasing to 110 dB at higher gains.

FUNCTIONAL BLOCK DIAGRAM

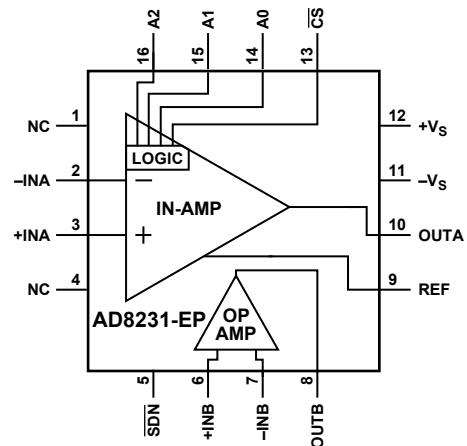

Figure 1.

Table 1. Instrumentation and Difference Amplifiers by Category

| High Performance | Low Cost | High Voltage | Mil Grade | Low Power | Digital Gain |
|---------------------|---------------------|--------------|-----------|--------------------|---------------------|
| AD8221 | AD623 ¹ | AD628 | AD620 | AD627 ¹ | AD8231 ¹ |
| AD8220 ¹ | AD8553 ¹ | AD629 | AD621 | | AD8250 |
| AD8222 | | | AD524 | | AD8251 |
| AD8224 ¹ | | | AD526 | | AD8555 ¹ |
| | | | AD624 | | AD8556 ¹ |
| | | | | | AD8557 ¹ |

¹ Rail-to-rail output.

The AD8231-EP also includes an uncommitted op amp that can be used for additional gain, differential signal driving, or filtering. Like the in-amp, the op amp has an auto-zero architecture, rail-to-rail input, and rail-to-rail output.

The AD8231-EP includes a shutdown feature that reduces current to a maximum of 1 μA. In shutdown, both amplifiers also have a high output impedance, which allows easy multiplexing of multiple amplifiers without additional switches.

The AD8231-EP is specified over the military temperature range of -55°C to +125°C. It is available in a 4 mm × 4 mm 16-lead LFCSP.

Additional application and technical information can be found in the [AD8231](#) data sheet.

TABLE OF CONTENTS

| | | | |
|---------------------------------|---|---------------------------------------------------|----|
| Features | 1 | ESD Caution..... | 7 |
| Enhanced Product Features | 1 | Pin Configuration and Function Descriptions..... | 8 |
| Functional Block Diagram | 1 | Typical Performance Characteristics | 8 |
| General Description | 1 | Instrumentation Amplifier Performance Curves..... | 9 |
| Revision History | 2 | Operational Amplifier Performance Curves | 15 |
| Specifications..... | 3 | Performance Curves Valid for Both Amplifiers..... | 17 |
| Absolute Maximum Ratings..... | 7 | Outline Dimensions | 18 |
| Thermal Resistance | 7 | Ordering Guide | 18 |
| Maximum Power Dissipation | 7 | | |

REVISION HISTORY

11/2017—Rev. 0 to Rev. A

| | |
|-----------------------------------|------------|
| Changed CP-16-4 to CP-16-17 | Throughout |
| Updated Outline Dimensions | 18 |
| Changes to Ordering Guide | 18 |

5/2011—Revision 0: Initial Version

SPECIFICATIONS

$V_S = 5\text{ V}$, $V_{REF} = 2.5\text{ V}$, $G = 1$, $R_L = 10\text{ k}\Omega$, $T_A = 25^\circ\text{C}$, unless otherwise noted.

Table 2.

| Parameter | Test Conditions/Comments | Min | Typ | Max | Unit |
|----------------------------------|------------------------------------------------------------------------------|------|-------|------|------------------------------|
| INSTRUMENTATION AMPLIFIER | | | | | |
| Offset Voltage | $V_{OS\ RTI} = V_{OSI} + V_{OSO}/G$ | | | | |
| Input Offset, V_{OSI} | | | 4 | 15 | μV |
| Average Temperature Drift | $T_A = -55^\circ\text{C}$ to $+125^\circ\text{C}$ | | 0.01 | 0.05 | $\mu\text{V}/^\circ\text{C}$ |
| Output Offset, V_{OSO} | | | 15 | 30 | μV |
| Average Temperature Drift | $T_A = -55^\circ\text{C}$ to $+125^\circ\text{C}$ | | 0.05 | 0.5 | $\mu\text{V}/^\circ\text{C}$ |
| Input Currents | | | | | |
| Input Bias Current | | | 250 | 500 | pA |
| Input Offset Current | $T_A = -55^\circ\text{C}$ to $+125^\circ\text{C}$ | | | 5 | nA |
| Input Offset Current | $T_A = -55^\circ\text{C}$ to $+125^\circ\text{C}$ | | 20 | 100 | pA |
| Input Offset Current | $T_A = -55^\circ\text{C}$ to $+125^\circ\text{C}$ | | | 0.5 | nA |
| Gains | 1, 2, 4, 8, 16, 32, 64, or 128 | | | | |
| Gain Error | | | | | |
| G = 1 | | | | 0.05 | % |
| G = 2 to 128 | | | | 0.8 | % |
| Gain Drift | $T_A = -55^\circ\text{C}$ to $+125^\circ\text{C}$ | | | | |
| G = 1 to 32 | | | 3 | 10 | ppm/ $^\circ\text{C}$ |
| G = 64 | | | 4 | 20 | ppm/ $^\circ\text{C}$ |
| G = 128 | | | 10 | 30 | ppm/ $^\circ\text{C}$ |
| Linearity | 0.2 V to 4.8 V, 10 k Ω load | | 3 | | ppm |
| | 0.2 V to 4.8 V, 2 k Ω load | | 5 | | ppm |
| CMRR | | | | | |
| G = 1 | | 80 | | | dB |
| G = 2 | | 86 | | | dB |
| G = 4 | | 92 | | | dB |
| G = 8 | | 98 | | | dB |
| G = 16 | | 104 | | | dB |
| G = 32 | | 110 | | | dB |
| G = 64 | | 110 | | | dB |
| G = 128 | | 110 | | | dB |
| Noise | $e_n = \sqrt{(e_{ni}^2 + (e_{no}/G)^2)}$, $V_{IN+}, V_{IN-} = 2.5\text{ V}$ | | | | |
| Input Voltage Noise, e_{ni} | f = 1 kHz | | 32 | | nV/ $\sqrt{\text{Hz}}$ |
| | f = 1 kHz, $T_A = -55^\circ\text{C}$ | | 27 | | nV/ $\sqrt{\text{Hz}}$ |
| | f = 1 kHz, $T_A = 125^\circ\text{C}$ | | 39 | | nV/ $\sqrt{\text{Hz}}$ |
| Output Voltage Noise, e_{no} | f = 0.1 Hz to 10 Hz | | 0.7 | | μV p-p |
| | f = 1 kHz | | 58 | | nV/ $\sqrt{\text{Hz}}$ |
| | f = 1 kHz, $T_A = -55^\circ\text{C}$ | | 50 | | nV/ $\sqrt{\text{Hz}}$ |
| | f = 1 kHz, $T_A = 125^\circ\text{C}$ | | 70 | | nV/ $\sqrt{\text{Hz}}$ |
| | f = 0.1 Hz to 10 Hz | | 1.1 | | μV p-p |
| Current Noise | f = 10 Hz | | 20 | | fA/ $\sqrt{\text{Hz}}$ |
| Other Input Characteristics | | | | | |
| Common-Mode Input Impedance | | | 10 5 | | G Ω pF |
| Power Supply Rejection Ratio | | 100 | 115 | | dB |
| Input Operating Voltage Range | | 0.05 | | 4.95 | V |
| Reference Input | | | | | |
| Input Impedance | | | 28 | | k Ω |
| Voltage Range | | -0.2 | | +5.2 | V |

| Parameter | Test Conditions/Comments | Min | Typ | Max | Unit |
|---------------------------------------------|---------------------------------------------------|------|------|------|---------------------------|
| Dynamic Performance | | | | | |
| Bandwidth | | | | | |
| G = 1 | | | 2.7 | | MHz |
| G = 2 | | | 2.5 | | MHz |
| Gain Bandwidth Product | | | | | |
| G = 4 to 128 | | | 7 | | MHz |
| Slew Rate | | | 1.1 | | V/ μ s |
| Output Characteristics | | | | | |
| Output Voltage High | $R_L = 100\text{ k}\Omega$ to ground | 4.9 | 4.94 | | V |
| | $R_L = 10\text{ k}\Omega$ to ground | 4.8 | 4.88 | | V |
| Output Voltage Low | $R_L = 100\text{ k}\Omega$ to 5 V | | 60 | 100 | mV |
| | $R_L = 10\text{ k}\Omega$ to 5 V | | 80 | 200 | mV |
| Short-Circuit Current | | | 70 | | mA |
| Digital Interface | | | | | |
| Input Voltage Low | $T_A = -55^\circ\text{C}$ to $+125^\circ\text{C}$ | | | 1.0 | V |
| Input Voltage High | $T_A = -55^\circ\text{C}$ to $+125^\circ\text{C}$ | 4.0 | | | V |
| Setup Time to $\overline{\text{CS}}$ High | $T_A = -55^\circ\text{C}$ to $+125^\circ\text{C}$ | 50 | | | ns |
| Hold Time after $\overline{\text{CS}}$ High | $T_A = -55^\circ\text{C}$ to $+125^\circ\text{C}$ | 20 | | | ns |
| OPERATIONAL AMPLIFIER | | | | | |
| Input Characteristics | | | | | |
| Offset Voltage, V_{OS} | | | 5 | 15 | μ V |
| Temperature Drift | $T_A = -55^\circ\text{C}$ to $+125^\circ\text{C}$ | | 0.01 | 0.06 | μ V/ $^\circ\text{C}$ |
| Input Bias Current | | | 250 | 500 | pA |
| | $T_A = -55^\circ\text{C}$ to $+125^\circ\text{C}$ | | | 5 | nA |
| Input Offset Current | | | 20 | 100 | pA |
| | $T_A = -55^\circ\text{C}$ to $+125^\circ\text{C}$ | | | 0.5 | nA |
| Input Voltage Range | | 0.05 | | 4.95 | V |
| Open-Loop Gain | | 100 | 120 | | V/mV |
| Common-Mode Rejection Ratio | | 100 | 120 | | dB |
| Power Supply Rejection Ratio | | 100 | 110 | | dB |
| Voltage Noise Density | | | 20 | | nV/ $\sqrt{\text{Hz}}$ |
| Voltage Noise | $f = 0.1\text{ Hz}$ to 10 Hz | | 0.4 | | μ V p-p |
| Dynamic Performance | | | | | |
| Gain Bandwidth Product | | | 1 | | MHz |
| Slew Rate | | | 0.5 | | V/ μ s |
| Output Characteristics | | | | | |
| Output Voltage High | $R_L = 100\text{ k}\Omega$ to ground | 4.9 | 4.96 | | V |
| | $R_L = 10\text{ k}\Omega$ to ground | 4.8 | 4.92 | | V |
| Output Voltage Low | $R_L = 100\text{ k}\Omega$ to 5 V | | 60 | 100 | mV |
| | $R_L = 10\text{ k}\Omega$ to 5 V | | 80 | 200 | mV |
| Short-Circuit Current | | | 70 | | mA |
| BOTH AMPLIFIERS | | | | | |
| Power Supply | | | | | |
| Quiescent Current | | | 4 | 5 | mA |
| Quiescent Current (Shutdown) | | | 0.01 | 1 | μ A |

$V_S = 3.0\text{ V}$, $V_{REF} = 1.5\text{ V}$, $T_A = 25^\circ\text{C}$, $G = 1$, $R_L = 10\text{ k}\Omega$, unless otherwise noted.

Table 3.

| Parameter | Conditions | Min | Typ | Max | Unit |
|----------------------------------|----------------------------------------------------------------------------------------------------------|------|-------|------|------------------------------|
| INSTRUMENTATION AMPLIFIER | | | | | |
| Offset Voltage | $V_{OS\ RTI} = V_{OSI} + V_{OSO}/G$ | | | | |
| Input Offset, V_{OSI} | | | 4 | 15 | μV |
| Average Temperature Drift | | | 0.01 | 0.05 | $\mu\text{V}/^\circ\text{C}$ |
| Output Offset, V_{OSO} | | | 15 | 30 | μV |
| Average Temperature Drift | | | 0.05 | 0.5 | $\mu\text{V}/^\circ\text{C}$ |
| Input Currents | | | | | |
| Input Bias Current | | | 250 | 500 | pA |
| Input Offset Current | $T_A = -55^\circ\text{C}$ to $+125^\circ\text{C}$ | | | 5 | nA |
| | | | 20 | 100 | pA |
| | $T_A = -55^\circ\text{C}$ to $+125^\circ\text{C}$ | | | 0.5 | nA |
| Gains | 1, 2, 4, 8, 16, 32, 64, or 128 | | | | |
| Gain Error | | | | | |
| $G = 1$ | | | | 0.05 | % |
| $G = 2$ to 128 | | | | 0.8 | % |
| Gain Drift | $T_A = -55^\circ\text{C}$ to $+125^\circ\text{C}$ | | | | |
| $G = 1$ to 32 | | | 3 | 10 | $\text{ppm}/^\circ\text{C}$ |
| $G = 64$ | | | 4 | 20 | $\text{ppm}/^\circ\text{C}$ |
| $G = 128$ | | | 10 | 30 | $\text{ppm}/^\circ\text{C}$ |
| CMRR | | | | | |
| $G = 1$ | | 80 | | | dB |
| $G = 2$ | | 86 | | | dB |
| $G = 4$ | | 92 | | | dB |
| $G = 8$ | | 98 | | | dB |
| $G = 16$ | | 104 | | | dB |
| $G = 32$ | | 110 | | | dB |
| $G = 64$ | | 110 | | | dB |
| $G = 128$ | | 110 | | | dB |
| Noise | $e_n = \sqrt{(e_{ni})^2 + (e_{no}/G)^2}$ $V_{IN+}, V_{IN-} = 2.5\text{ V}$, $T_A = 25^\circ\text{C}$ | | | | |
| Input Voltage Noise, e_{ni} | $f = 1\text{ kHz}$ | | 40 | | $\text{nV}/\sqrt{\text{Hz}}$ |
| | $f = 1\text{ kHz}$, $T_A = -55^\circ\text{C}$ | | 35 | | $\text{nV}/\sqrt{\text{Hz}}$ |
| | $f = 1\text{ kHz}$, $T_A = 125^\circ\text{C}$ | | 48 | | $\text{nV}/\sqrt{\text{Hz}}$ |
| Output Voltage Noise, e_{no} | $f = 0.1\text{ Hz}$ to 10 Hz | | 0.8 | | $\mu\text{V p-p}$ |
| | $f = 1\text{ kHz}$ | | 72 | | $\text{nV}/\sqrt{\text{Hz}}$ |
| | $f = 1\text{ kHz}$, $T_A = -55^\circ\text{C}$ | | 62 | | $\text{nV}/\sqrt{\text{Hz}}$ |
| | $f = 1\text{ kHz}$, $T_A = 125^\circ\text{C}$ | | 83 | | $\text{nV}/\sqrt{\text{Hz}}$ |
| | $f = 0.1\text{ Hz}$ to 10 Hz | | 1.4 | | $\mu\text{V p-p}$ |
| Current Noise | $f = 10\text{ Hz}$ | | 20 | | $\text{fA}/\sqrt{\text{Hz}}$ |
| Other Input Characteristics | | | | | |
| Common-Mode Input Impedance | | | 10 5 | | $\text{G}\Omega \text{pF}$ |
| Power Supply Rejection Ratio | | 100 | 115 | | dB |
| Input Operating Voltage Range | | 0.05 | | 2.95 | V |
| Reference Input | | | | | |
| Input Impedance | | | 28 | | $\text{k}\Omega \text{pF}$ |
| Voltage Range | | -0.2 | | +3.2 | V |

| Parameter | Conditions | Min | Typ | Max | Unit |
|---------------------------------------------|---------------------------------------------------|------|------|------|--------|
| Dynamic Performance | | | | | |
| Bandwidth | | | | | |
| G = 1 | | | 2.7 | | MHz |
| G = 2 | | | 2.5 | | MHz |
| Gain Bandwidth Product | | | | | |
| G = 4 to 128 | | | 7 | | MHz |
| Slew Rate | | | 1.1 | | V/μs |
| Output Characteristics | | | | | |
| Output Voltage High | $R_L = 100\text{ k}\Omega$ to ground | 2.9 | 2.94 | | V |
| | $R_L = 10\text{ k}\Omega$ to ground | 2.8 | 2.88 | | V |
| Output Voltage Low | $R_L = 100\text{ k}\Omega$ to 3 V | | 60 | 100 | mV |
| | $R_L = 10\text{ k}\Omega$ to 3 V | | 80 | 200 | mV |
| Short-Circuit Current | | | 40 | | mA |
| Digital Interface | | | | | |
| Input Voltage Low | $T_A = -55^\circ\text{C}$ to $+125^\circ\text{C}$ | | | 0.7 | V |
| Input Voltage High | $T_A = -55^\circ\text{C}$ to $+125^\circ\text{C}$ | 2.3 | | | V |
| Setup Time to $\overline{\text{CS}}$ High | $T_A = -55^\circ\text{C}$ to $+125^\circ\text{C}$ | 60 | | | ns |
| Hold Time after $\overline{\text{CS}}$ High | $T_A = -55^\circ\text{C}$ to $+125^\circ\text{C}$ | 20 | | | ns |
| OPERATIONAL AMPLIFIERS | | | | | |
| Input Characteristics | | | | | |
| Offset Voltage, V_{os} | | | 5 | 15 | μV |
| Temperature Drift | $T_A = -55^\circ\text{C}$ to $+125^\circ\text{C}$ | | 0.01 | 0.06 | μV/°C |
| Input Bias Current | | | 250 | 500 | pA |
| | $T_A = -55^\circ\text{C}$ to $+125^\circ\text{C}$ | | | 5 | nA |
| Input Offset Current | | | 20 | 100 | pA |
| | $T_A = -55^\circ\text{C}$ to $+125^\circ\text{C}$ | | | 0.5 | nA |
| Input Voltage Range | | 0.05 | | 2.95 | V |
| Open-Loop Gain | | 100 | 120 | | V/mV |
| Common-Mode Rejection Ratio | | 100 | 120 | | dB |
| Power Supply Rejection Ratio | | 100 | 110 | | dB |
| Voltage Noise Density | | | 27 | | nV/√Hz |
| Voltage Noise | $f = 0.1\text{ Hz}$ to 10 Hz | | 0.6 | | μV p-p |
| Dynamic Performance | | | | | |
| Gain Bandwidth Product | | | 1 | | MHz |
| Slew Rate | | | 0.5 | | V/μs |
| Output Characteristics | | | | | |
| Output Voltage High | $R_L = 100\text{ k}\Omega$ to ground | 2.9 | 2.96 | | V |
| | $R_L = 10\text{ k}\Omega$ to ground | 2.8 | 2.82 | | V |
| Output Voltage Low | $R_L = 100\text{ k}\Omega$ to 3 V | | 60 | 100 | mV |
| | $R_L = 10\text{ k}\Omega$ to 3 V | | 80 | 200 | mV |
| Short-Circuit Current | | | 40 | | mA |
| BOTH AMPLIFIERS | | | | | |
| Power Supply | | | | | |
| Quiescent Current | | | 3.5 | 4.5 | mA |
| Quiescent Current (Shutdown) | | | 0.01 | 1 | μA |

ABSOLUTE MAXIMUM RATINGS

Table 4.

| Parameter | Rating |
|--------------------------------------|--------------------------------------------------|
| Supply Voltage | 6 V |
| Output Short-Circuit Current | Indefinite ¹ |
| Input Voltage (Common-Mode) | $-V_S - 0.3 \text{ V}$ to $+V_S + 0.3 \text{ V}$ |
| Differential Input Voltage | $-V_S - 0.3 \text{ V}$ to $+V_S + 0.3 \text{ V}$ |
| Storage Temperature Range | -65°C to $+150^\circ\text{C}$ |
| Operational Temperature Range | -55°C to $+125^\circ\text{C}$ |
| Package Glass Transition Temperature | 130°C |
| ESD (Human Body Model) | 1.5 kV |
| ESD (Charged Device Model) | 1.5 kV |
| ESD (Machine Model) | 0.2 kV |

¹ For junction temperatures between 105°C and 130°C, short-circuit operation beyond 1000 hours can impact part reliability.

Stresses above those listed under Absolute Maximum Ratings may cause permanent damage to the device. This is a stress rating only; functional operation of the device at these or any other conditions above those indicated in the operational section of this specification is not implied. Exposure to absolute maximum rating conditions for extended periods may affect device reliability.

THERMAL RESISTANCE

Table 5.

| Thermal Pad | θ_{JA} | Unit |
|-----------------------|---------------|---------------------------|
| Soldered to Board | 54 | $^\circ\text{C}/\text{W}$ |
| Not Soldered to Board | 96 | $^\circ\text{C}/\text{W}$ |

The θ_{JA} values in Table 5 assume a 4-layer JEDEC standard board. If the thermal pad is soldered to the board, it is also assumed it is connected to a plane. θ_{JC} at the exposed pad is $6.3^\circ\text{C}/\text{W}$.

MAXIMUM POWER DISSIPATION

The maximum safe power dissipation for the AD8231-EP is limited by the associated rise in junction temperature (T_j) on the die. At approximately 130°C, which is the glass transition temperature, the plastic changes its properties. Even temporarily exceeding this temperature limit may change the stresses that the package exerts on the die, permanently shifting the parametric performance of the amplifiers. Exceeding a temperature of 130°C for an extended period can result in a loss of functionality.

ESD CAUTION



ESD (electrostatic discharge) sensitive device. Charged devices and circuit boards can discharge without detection. Although this product features patented or proprietary protection circuitry, damage may occur on devices subjected to high energy ESD. Therefore, proper ESD precautions should be taken to avoid performance degradation or loss of functionality.

PIN CONFIGURATION AND FUNCTION DESCRIPTIONS

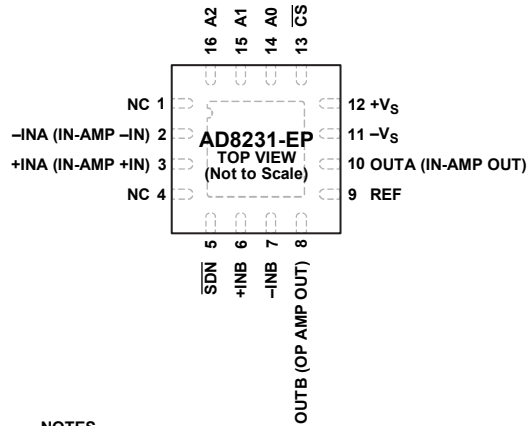

- NOTES
1. NC = NO CONNECT. DO NOT CONNECT TO THIS PIN.
 2. THE EXPOSED PAD CAN BE CONNECTED TO THE NEGATIVE SUPPLY ($-V_S$) OR LEFT FLOATING.

09707-002

Figure 2. Pin Configuration

Table 6. Pin Function Descriptions

| Pin Number | Mnemonic | Description |
|------------|-------------------------|--------------------------------------------------------------------------------------------------------------------|
| 1 | NC | No Connect. Do not connect to this pin. |
| 2 | -INA (IN-AMP -IN) | Instrumentation Amplifier Negative Input. |
| 3 | +INA (IN-AMP +IN) | Instrumentation Amplifier Positive Input. |
| 4 | NC | No Connect. Do not connect to this pin. |
| 5 | $\overline{\text{SDN}}$ | Shutdown. |
| 6 | +INB | Operational Amplifier Positive Input. |
| 7 | -INB | Operational Amplifier Negative Input. |
| 8 | OUTB (OP AMP OUT) | Operational Amplifier Output. |
| 9 | REF | Instrumentation Amplifier Reference Pin. It should be driven with a low impedance. Output is referred to this pin. |
| 10 | OUTA (IN-AMP OUT) | Instrumentation Amplifier Output. |
| 11 | $-V_S$ | Negative Power Supply. Connect to ground in single-supply applications. |
| 12 | $+V_S$ | Positive Power Supply. |
| 13 | $\overline{\text{CS}}$ | Chip Select. Enables digital logic interface. |
| 14 | A0 | Gain Setting Bit (LSB). |
| 15 | A1 | Gain Setting Bit. |
| 16 | A2 | Gain Setting Bit (MSB). |
| | EPAD | Exposed Pad. Can be connected to the negative supply ($-V_S$) or left floating. |

TYPICAL PERFORMANCE CHARACTERISTICS

INSTRUMENTATION AMPLIFIER PERFORMANCE CURVES

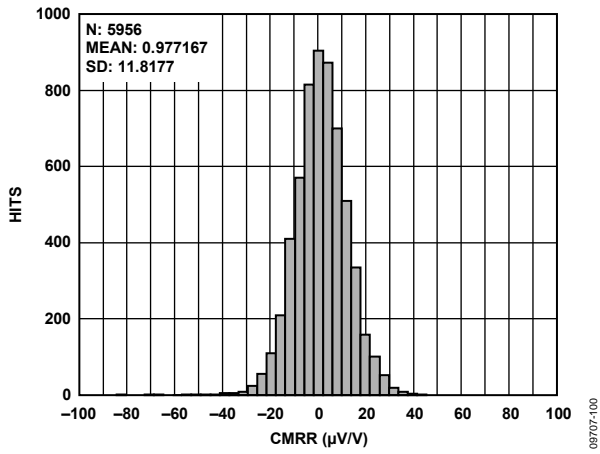

Figure 3. Instrumentation Amplifier CMR Distribution, G = 1

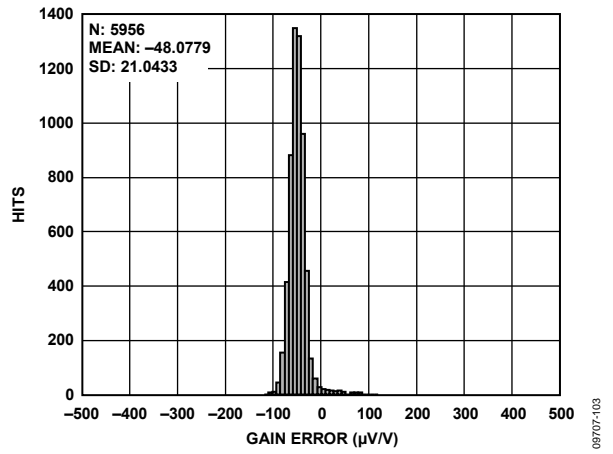

Figure 6. Instrumentation Amplifier Gain Distribution, G = 1

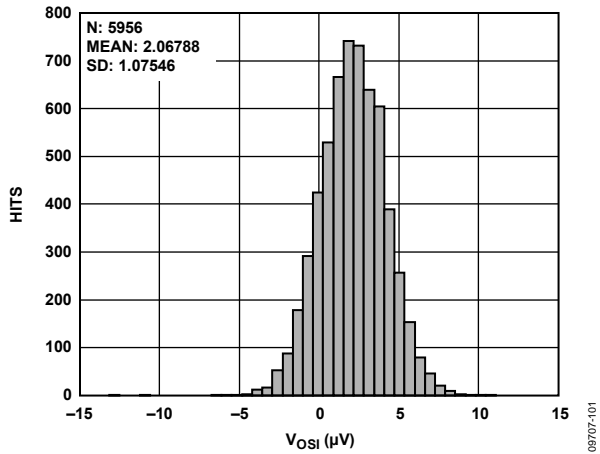

Figure 4. Instrumentation Amplifier Input Offset Voltage Distribution

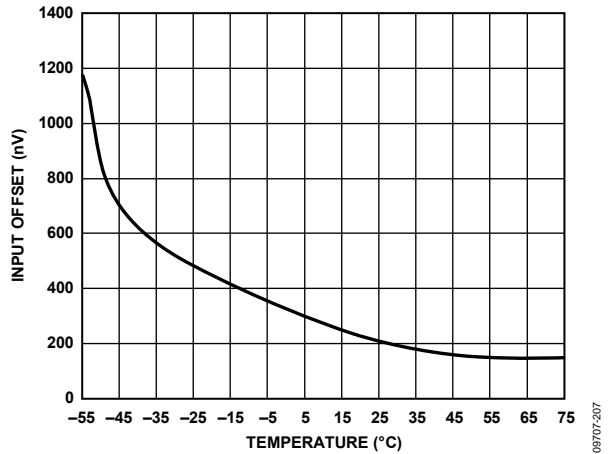

Figure 7. Instrumentation Amplifier Input Offset Voltage Drift, -55°C to +125°C

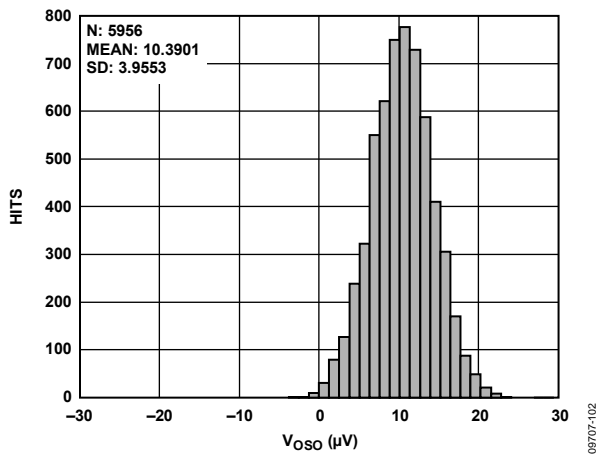

Figure 5. Instrumentation Amplifier Output Offset Voltage Distribution

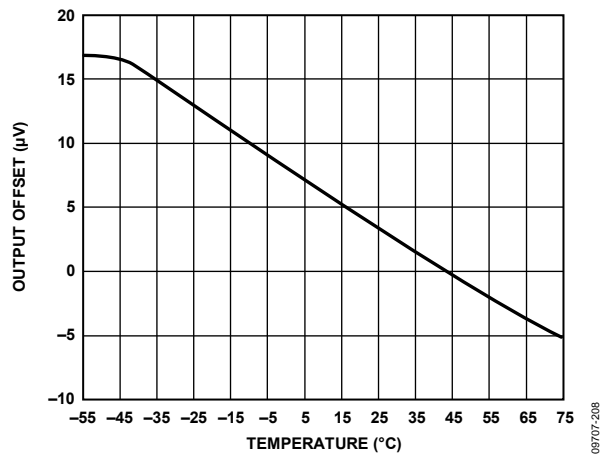

Figure 8. Instrumentation Amplifier Output Offset Drift, -55°C to +125°C

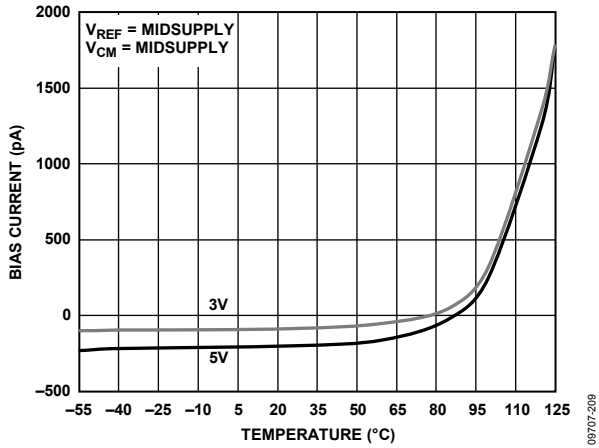

Figure 9. Instrumentation Amplifier Bias Current vs. Temperature

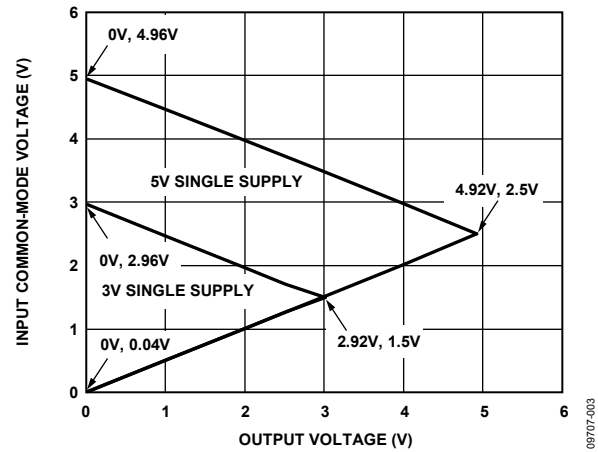

Figure 12. Instrumentation Amplifier Input Common-Mode Range vs. Output Voltage, $V_{REF} = 0\text{ V}$

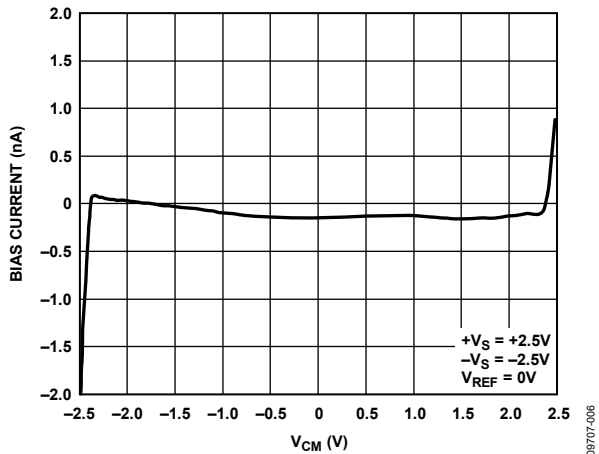

Figure 10. Instrumentation Amplifier Bias Current vs. Common-Mode Voltage, 5 V

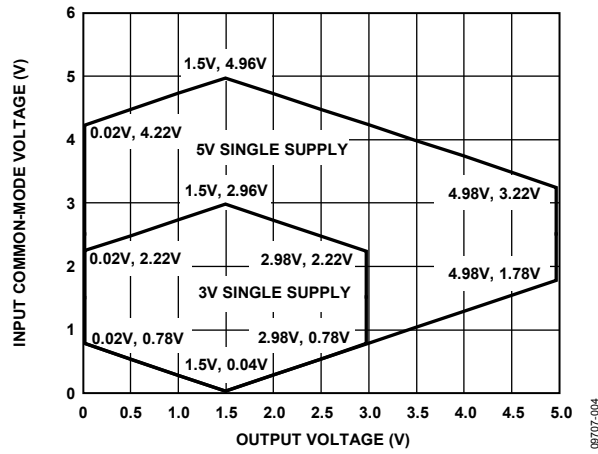

Figure 13. Instrumentation Amplifier Input Common-Mode Range vs. Output Voltage, $V_{REF} = 1.5\text{ V}$

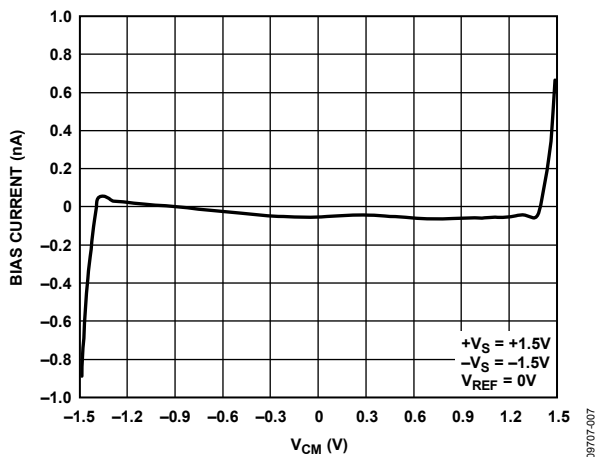

Figure 11. Instrumentation Amplifier Bias Current vs. Common-Mode Voltage, 3 V

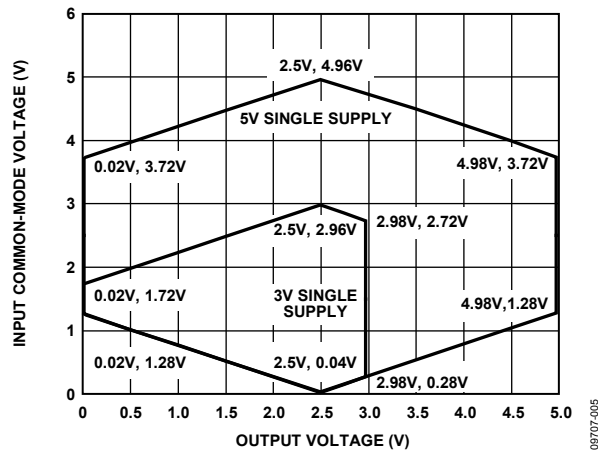

Figure 14. Instrumentation Amplifier Input Common-Mode Range vs. Output Voltage, $V_{REF} = 2.5\text{ V}$

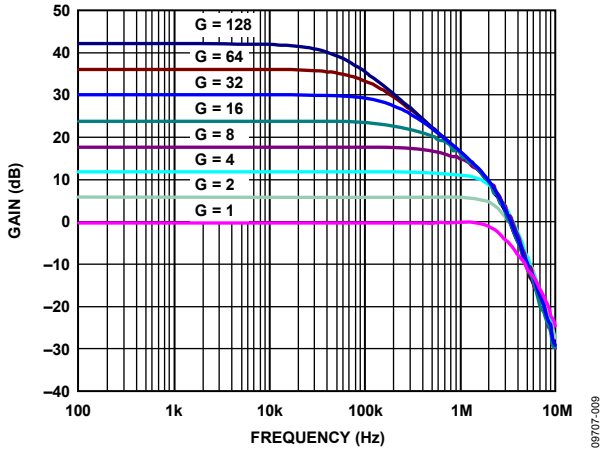

Figure 15. Instrumentation Amplifier Gain vs. Frequency

09707-009

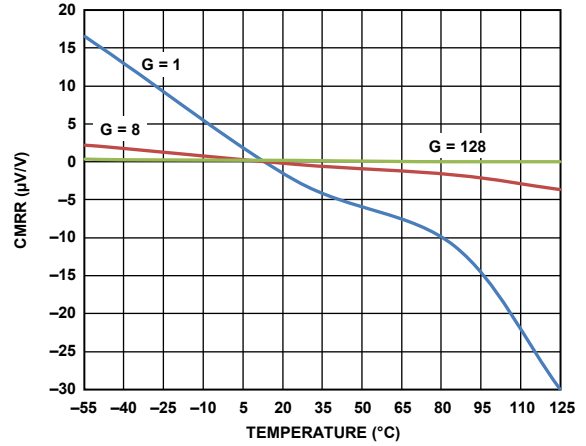

Figure 18. Instrumentation Amplifier CMRR vs. Temperature

09707-218

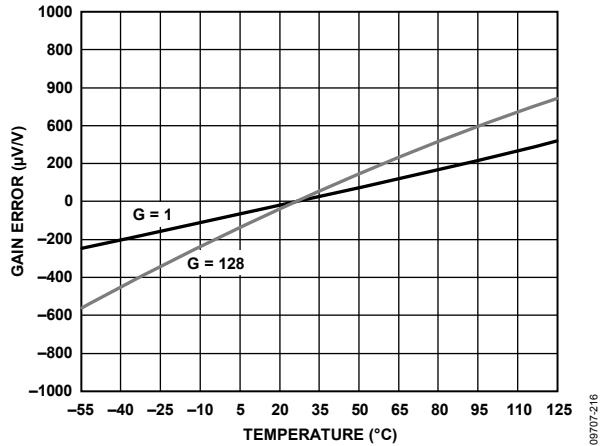

Figure 16. Instrumentation Amplifier Gain Drift vs. Temperature

09707-216

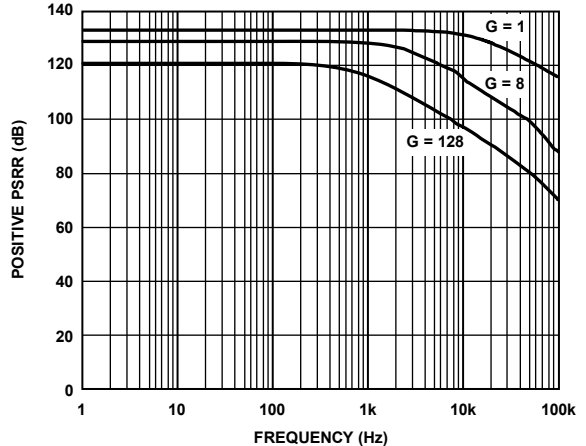

Figure 19. Instrumentation Amplifier Positive PSRR vs. Frequency

09707-146

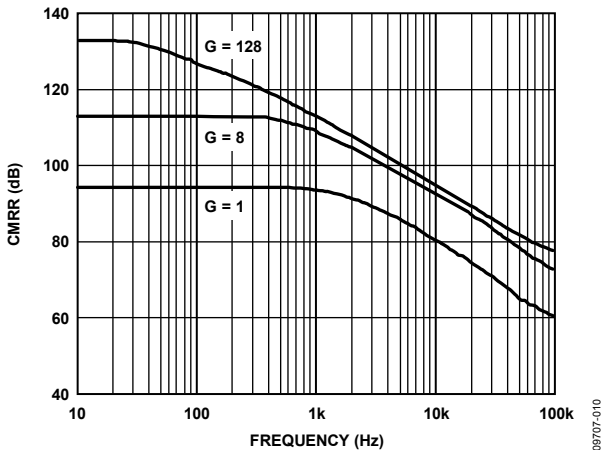

Figure 17. Instrumentation Amplifier CMRR vs. Frequency

09707-010

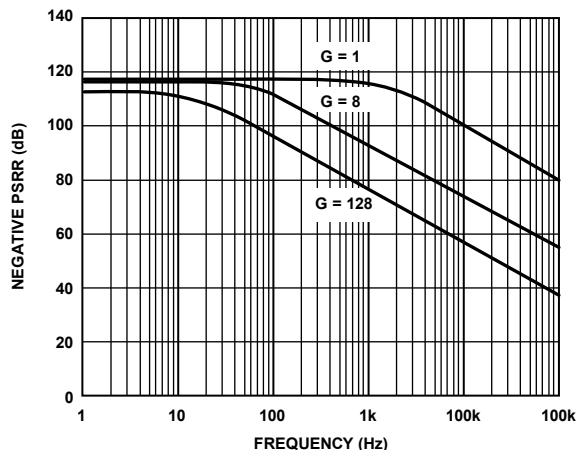

Figure 20. Instrumentation Amplifier Negative PSRR vs. Frequency

09707-147

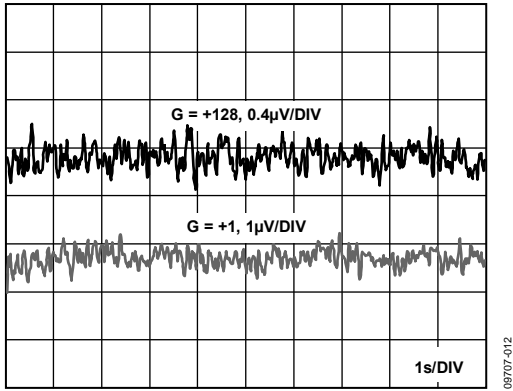

Figure 21. Instrumentation Amplifier 0.1 Hz to 10 Hz Noise

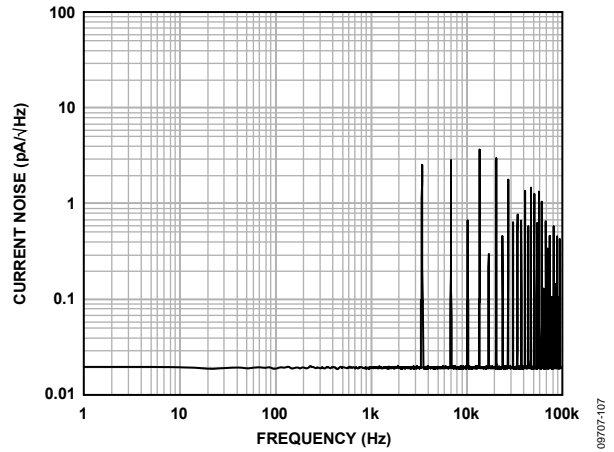

Figure 24. Instrumentation Amplifier Current Noise Spectral Density

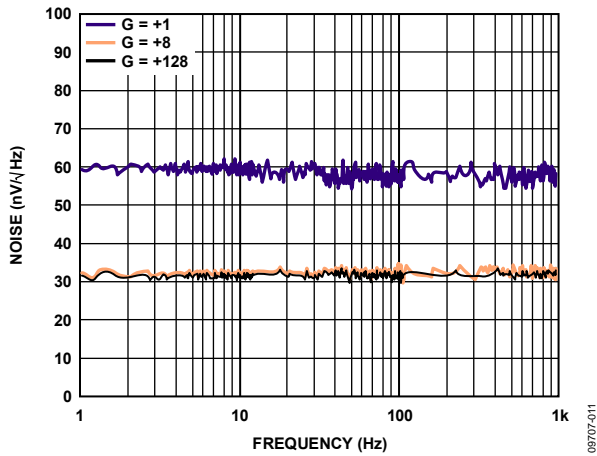

Figure 22. Instrumentation Amplifier Voltage Noise Spectral Density vs. Frequency, 5 V, 1 Hz to 1000 Hz

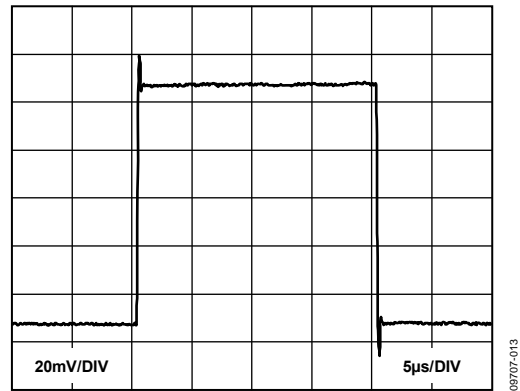

Figure 25. Instrumentation Amplifier Small Signal Pulse Response, $G = 1$, $R_L = 2\text{ k}\Omega$, $C_L = 500\text{ pF}$

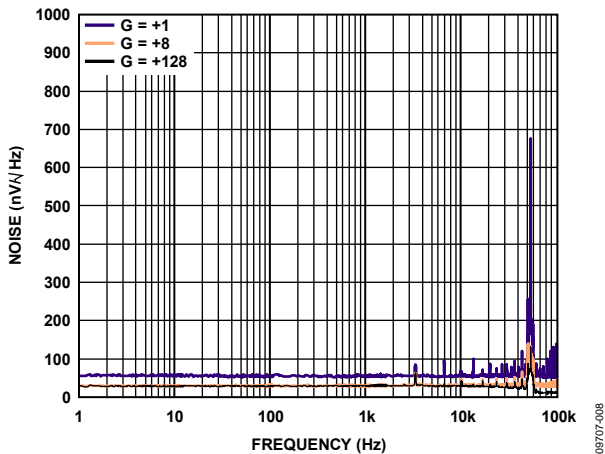

Figure 23. Instrumentation Amplifier Voltage Noise Spectral Density vs. Frequency, 5 V, 1 Hz to 1 MHz

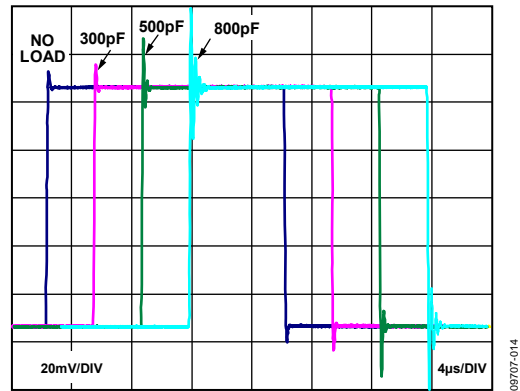

Figure 26. Instrumentation Amplifier Small Signal Pulse Response for Various Capacitive Loads, $G = 1$

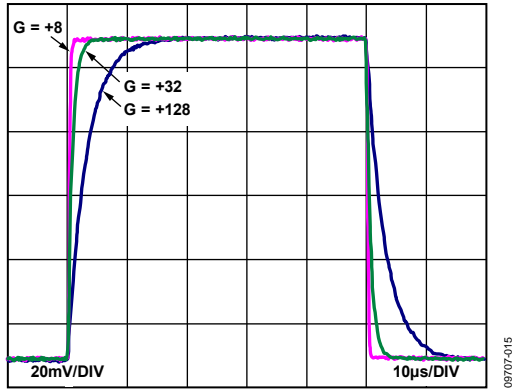

Figure 27. Instrumentation Amplifier Small Signal Pulse Response, $G = 4, 16,$ and $128, R_L = 2\text{ k}\Omega, C_L = 500\text{ pF}$

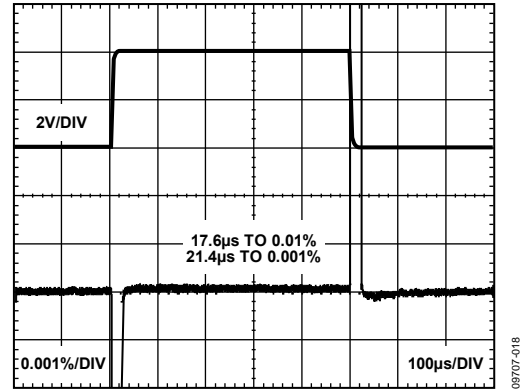

Figure 30. Instrumentation Amplifier Large Signal Pulse Response, $G = 128, V_S = 5\text{ V}$

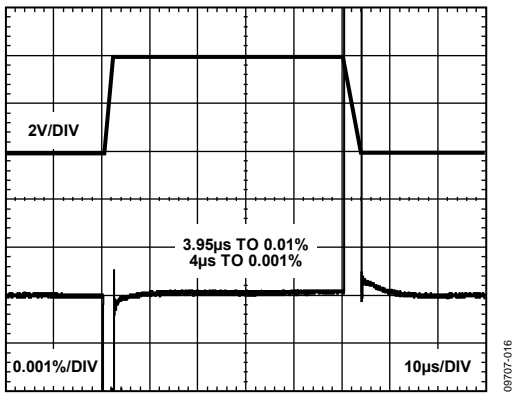

Figure 28. Instrumentation Amplifier Large Signal Pulse Response, $G = 1, V_S = 5\text{ V}$

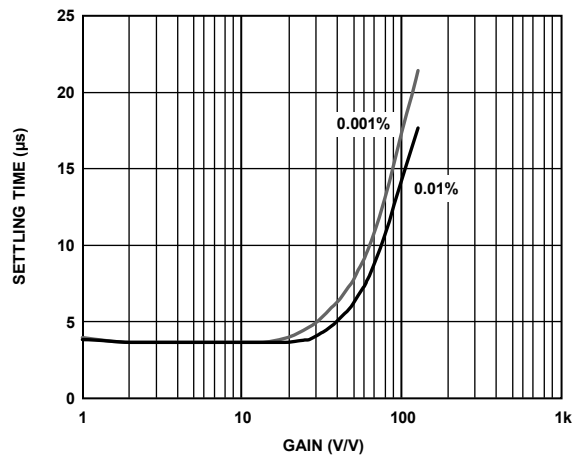

Figure 31. Instrumentation Amplifier Settling Time vs. Gain for a $4\text{ V p-p Step}, V_S = 5\text{ V}$

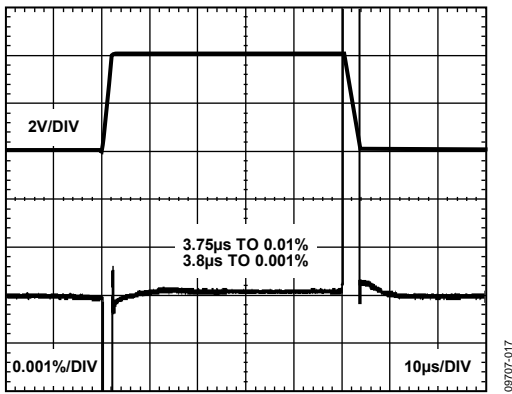

Figure 29. Instrumentation Amplifier Large Signal Pulse Response, $G = 8, V_S = 5\text{ V}$

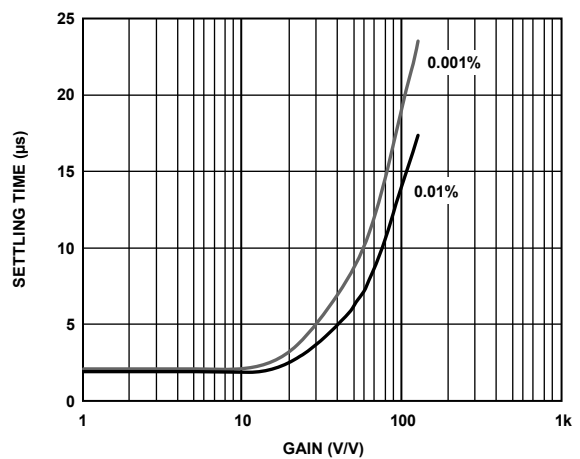

Figure 32. Instrumentation Amplifier Settling Time vs. Gain for a $2\text{ V p-p Step}, V_S = 3\text{ V}$

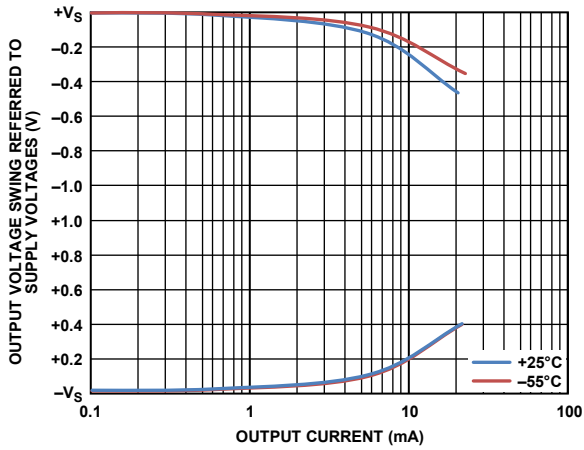

Figure 33. Instrumentation Amplifier Output Voltage Swing vs. Output Current, $V_S = 3\text{ V}$

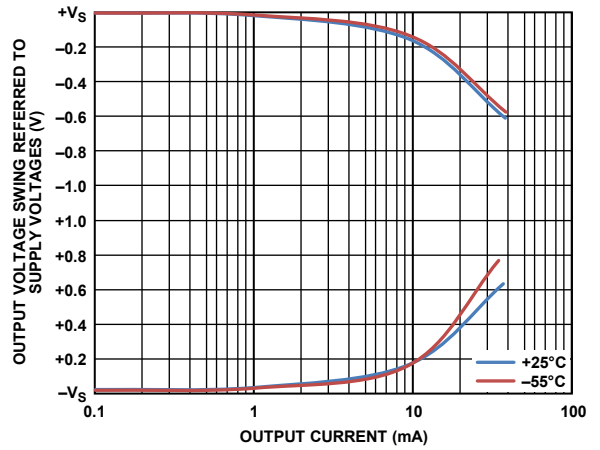

Figure 34. Instrumentation Amplifier Output Voltage Swing vs. Output Current, $V_S = 5\text{ V}$

08707-233

08707-234

OPERATIONAL AMPLIFIER PERFORMANCE CURVES

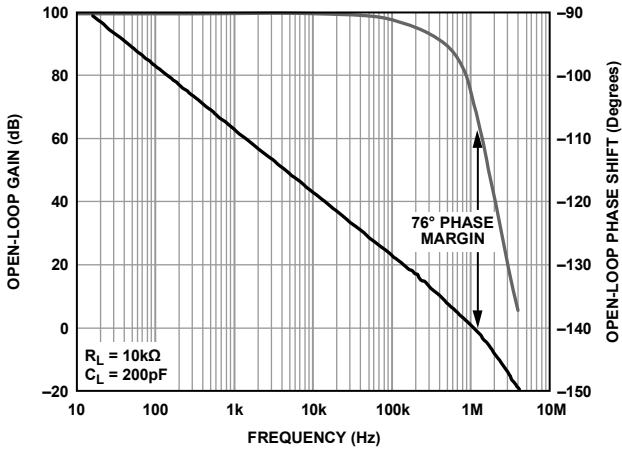

Figure 35. Operational Amplifier Open-Loop Gain and Phase vs. Frequency, $V_S = 5\text{ V}$

09707-021

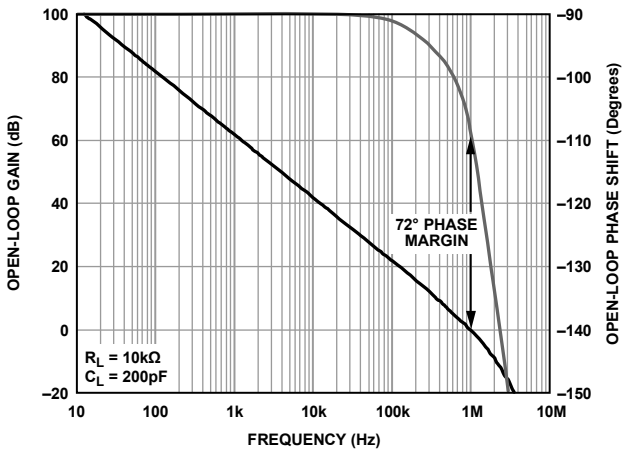

Figure 36. Operational Amplifier Open-Loop Gain and Phase vs. Frequency, $V_S = 3\text{ V}$

09707-022

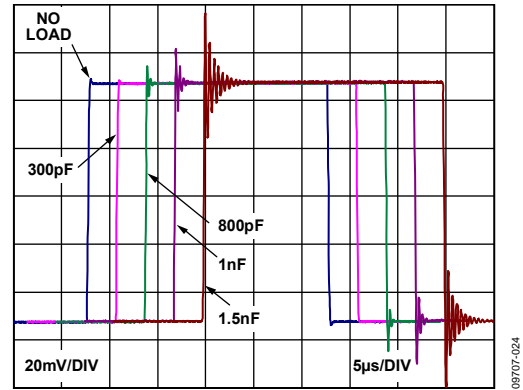

Figure 38. Operational Amplifier Small Signal Response for Various Capacitive Loads, $V_S = 3\text{ V}$

09707-024

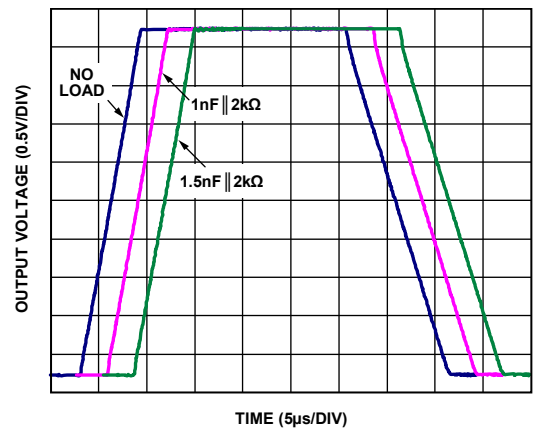

Figure 39. Operational Amplifier Large Signal Transient Response, $V_S = 5\text{ V}$

09707-025

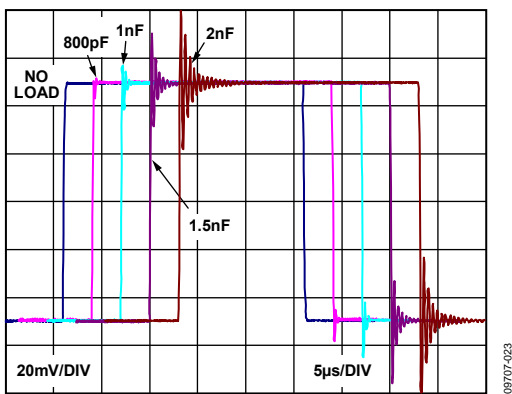

Figure 37. Operational Amplifier Small Signal Response for Various Capacitive Loads, $V_S = 5\text{ V}$

09707-023

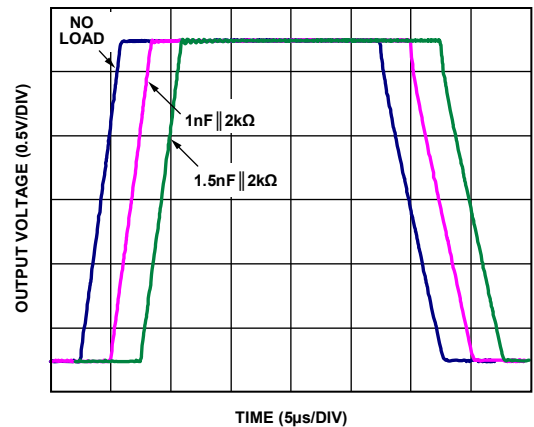

Figure 40. Operational Amplifier Large Signal Transient Response, $V_S = 3\text{ V}$

09707-026

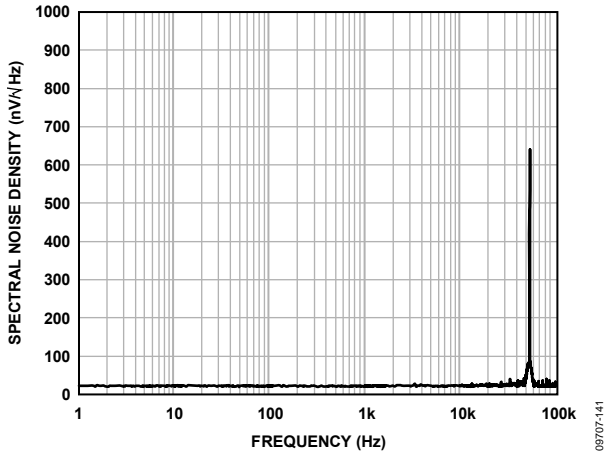

Figure 41. Operational Amplifier Voltage Spectral Noise Density vs. Frequency

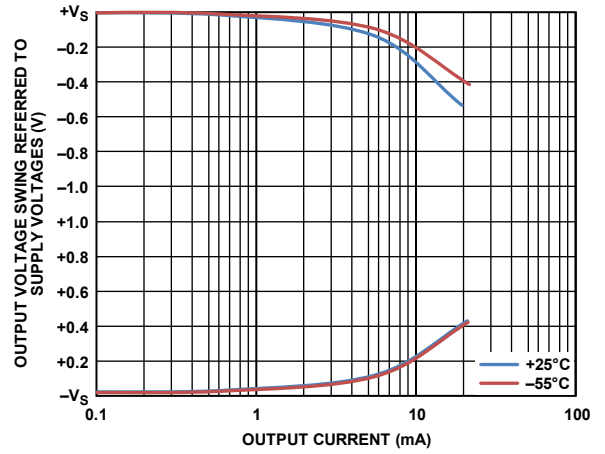

Figure 44. Operational Amplifier Output Voltage Swing vs. Output Current, $V_S = 3\text{ V}$

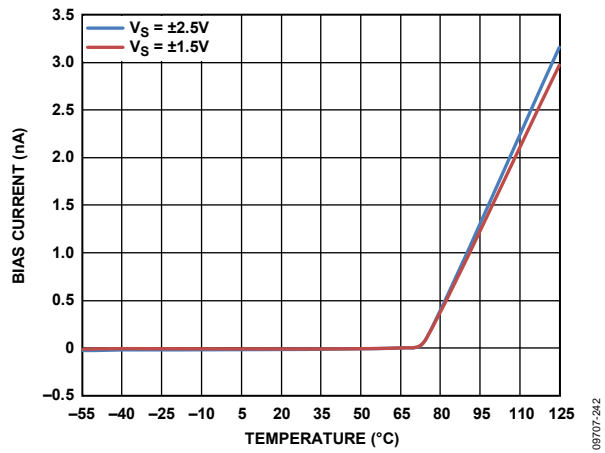

Figure 42. Operational Amplifier Bias Current vs. Temperature

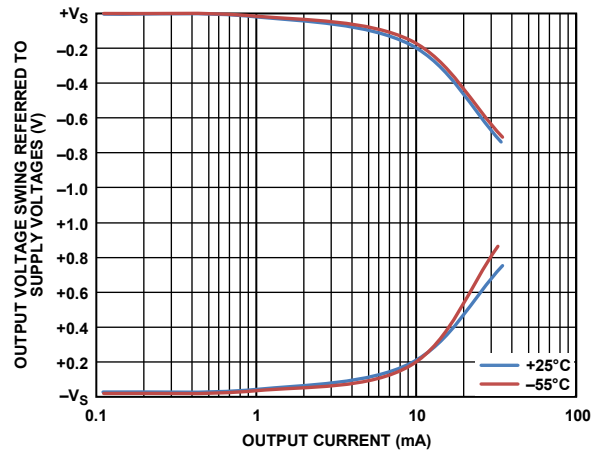

Figure 45. Operational Amplifier Output Voltage Swing vs. Output Current, $V_S = 5\text{ V}$

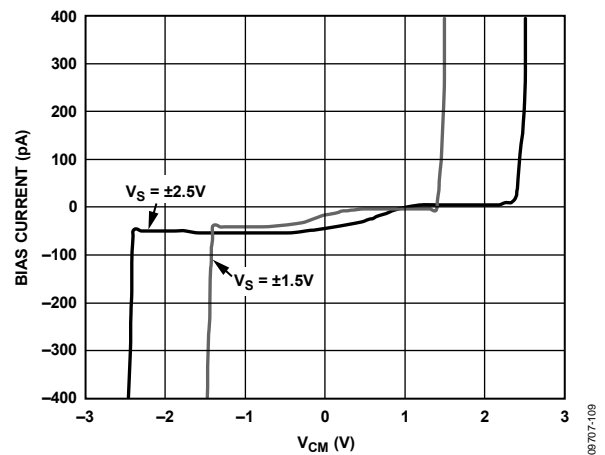

Figure 43. Operational Amplifier Bias Current vs. Common Mode

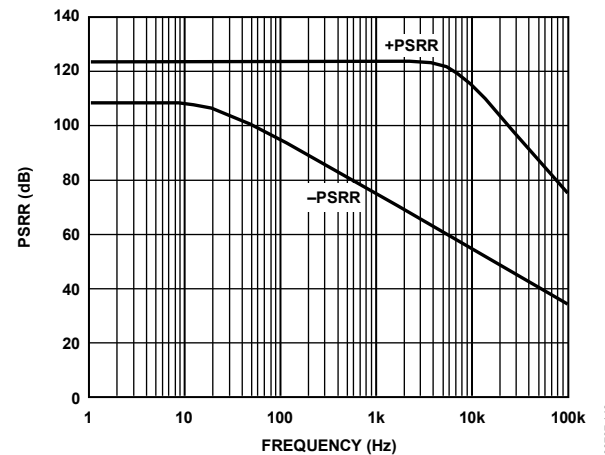

Figure 46. Operational Amplifier Power Supply Rejection Ratio

PERFORMANCE CURVES VALID FOR BOTH AMPLIFIERS

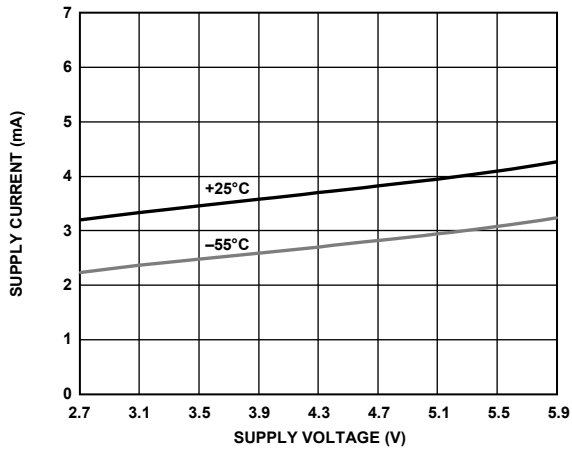

Figure 47. Supply Current vs. Supply Voltage

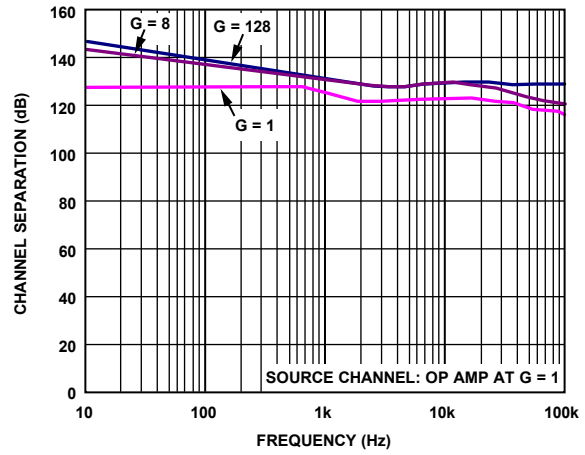
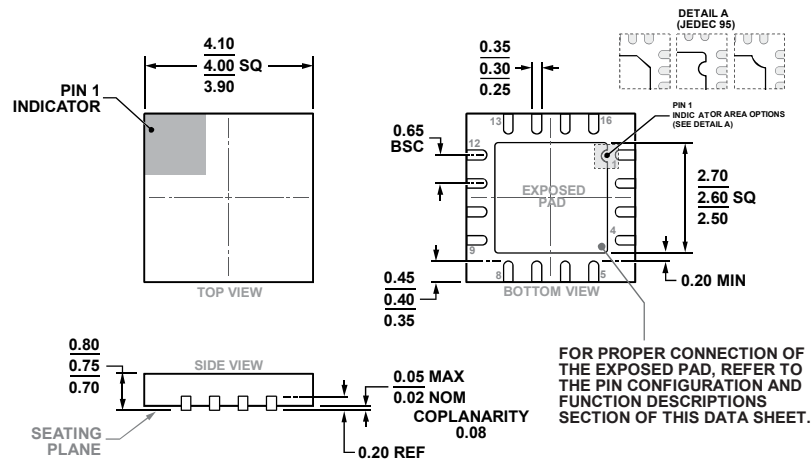

Figure 48. Channel Separation vs. Frequency

OUTLINE DIMENSIONS



COMPLIANT TO JEDEC STANDARDS MO-220-WGGC.

Figure 49. 16-Lead Lead Frame Chip Scale Package [LFCSP]
 4 mm × 4 mm Body and 0.75 mm Package Height
 (CP-16-17)

Dimensions shown in millimeters

ORDERING GUIDE

| Model ¹ | Temperature Range | Package Description | Package Option |
|--------------------|-------------------|---------------------------------|----------------|
| AD8231TCPZ-EP-R7 | -55°C to +125°C | 16-Lead LFCSP, 7" Tape and Reel | CP-16-17 |

¹ Z = RoHS Compliant Part.

NOTES

NOTES