

Slew Rate Verification for Wideband Amplifiers

The Taming of the Slew

Jim Williams

INTRODUCTION

Slew rate defines an amplifier's maximum rate of output excursion. This specification sets limits on undistorted bandwidth, an important capability in A/D driver applications. Slew rate also influences achievable performance in D/A output stages, filters, video amplification and data acquisition. Because of its importance, amplifier slew rate must be verified by measurement. Deriving a measurement approach requires understanding slew rate's relationship to amplifier dynamics.

Amplifier Dynamic Response

Figure 1 shows that amplifier dynamic response components include delay, slew and ring times. The *delay time* is small and is almost entirely due to amplifier propagation delay. During this interval there is no output movement. During *slew time* the amplifier moves at its highest possible speed towards the final value. *Ring time* defines the region where the amplifier recovers from slewing and ceases movement within some defined error band. The

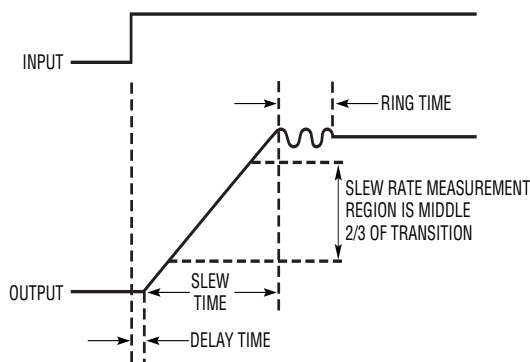

AN94 F01

Figure 1. Amplifier Response Components Include Delay, Slew and Ring Times. Slew Rate is Typically Measured During Middle 2/3 of Slew Time

Note 1. Although not considered here, settling time determination is a high order measurement challenge. It is treated in considerable detail in References 2, 3, and 4.

total elapsed time from input application until the output arrives at and remains within a specified error band around the final value is the *settling time*.¹

Slew rate, normally measured during the middle 2/3 of output movement at $A = +1$, is expressed in volts/microsecond. Discounting the initial and final movement intervals ensures that amplifier gain-bandwidth limitations during partial input overdrive do not influence the measurement.

Historically, slew rate measurement has been relatively simple.² Early amplifiers had slew rates of typically $1\text{V}/\mu\text{s}$, with later versions sometimes reaching hundreds of volts/ μs . Standard laboratory pulse generators easily supplied rise times well beyond amplifier speeds. As slew rates have crossed $1000\text{V}/\mu\text{s}$, the pulse generator's finite rise time has become a concern. A recent device, the LT1818 (See Box Section, "A $2500\text{V}/\mu\text{s}$ Slew Rate Amplifier with

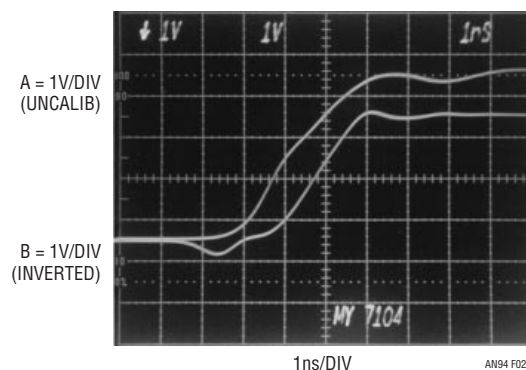

AN94 F02

Figure 2. LT1818 Slew Rate (Upper Trace) is Comparable to Schottky TTL Transition Time (Lower Trace)

LT, LTC and LT are registered trademarks of Linear Technology Corporation.

Note 2. The term "slew rate" has a clouded origin. Although used for many years in amplifier literature, there is no mention of it on the Philbrick K2-W (the first standard product op amp, introduced in January 1953) data sheet, dated 1964. Rather, the somewhat more dignified "maximum rate of output swing" is specified.

A 2500V/ μ S SLEW RATE AMPLIFIER WITH -85 dBc DISTORTION AT 5MHz

A/D driving, D/A output stages, data acquisition, video amplification and high frequency filters require low distortion, wideband amplifiers. The LT1818 amplifier (LT1819 is a dual version), with 2500V/ μ s slew rate, 400MHz GBW and -85 dBc distortion, is designed for these applications. Additionally, only 9mA supply current is required. The table provides short form specifications.

LT1818 Short Form Specifications

CHARACTERISTIC	SPECIFICATION
Gain – Bandwidth Product	400MHz (Typ) 270MHz (Min)
Full Power Bandwidth	95MHz (Typ)
Slew Rate	2500V/ μ s (Typ), A = +1
Delay	1ns (Typ)
Settling Time	10ns to 0.1% (Typ)
Distortion	-85 dBc at 5MHz (Typ)
Input Noise Voltage	6nV/ $\sqrt{\text{Hz}}$ (Typ)
DC Gain	2500 (Typ) 1500 (Min)
Output Current	± 70 mA (Typ) ± 40 mA (Min)
Input Voltage Range	± 3.5 V at ± 5 V Supplies (Min)
Input Bias Current	8 μ A (Max)

-85 dBc Distortion at 5MHz”), has a 2500V/ μ s slew rate, or 2.5V/nanosecond. Figure 2 puts this transition rate in perspective. The LT1818’s slew rate (Trace A) is comparable to a Schottky TTL gate’s (Trace B) transition time. Such speed eliminates almost all pulse generators as candidates for putting the amplifier into slew rate limiting.

Pulse Generator Rise Time Effects on Measurement

Pulse generator rise time limitations are a significant concern when attempting to accurately determine slew rate. Figures 3 through 6 demonstrate this by recording amplifier (at A = +1) response to progressively faster pulse generator rise times. Figure 3’s apparent slew rate limit is ≈ 385 V/ μ s when driven by a 10ns rise time pulse generator. Figure 4 indicates 800V/ μ s using a 5ns rise time generator. A 3.5ns rise time generator prompts Figure 5’s 1400V/ μ s response and a 1ns rise time instrument results in Figure 6’s 2500v/ μ s observed slew rate. Figure 7’s plot summarizes results. The data shows a non-linear slew rate increase as pulse generator rise time

decreases. The continuous slew rate increase with decreasing generator rise time, although approaching a zero rise time enforced bound, hints that slew rate limit has not been reached. Determining if this is so requires a faster pulse generator than Figure 6’s 1ns rise time unit.

Subnanosecond Rise Time Pulse Generators

The majority of general purpose pulse generators have rise times in the 2.5ns to 10ns range. Instrument rise times below 2.5ns are relatively rare, with only a select few types getting down to 1ns.³ The ranks of subnanosecond rise time generators are even thinner. Subnanosecond rise time generation, particularly if relatively large swings (e.g. 5V to 10V) are desired, employs arcane technologies and exotic construction techniques (see references 5–16 and 20). Available instruments in this class work well, but can easily cost \$10,000 with prices rising towards \$30,000 depending on features. For slew rate testing in a laboratory or production environment there is a substantially less expensive alternative.

360ps Rise Time Pulse Generator

Figure 8 shows a circuit for producing subnanosecond rise time pulses. Rise time is 360ps, with adjustable pulse amplitude. Output pulse occurrence is settable from before-to-after a trigger output. This circuit uses an avalanche pulse generator to create extremely fast rise time pulses.⁴

Q1 and Q2 form a current source that charges the 1000pF capacitor. When the LTC1799 clock is high (trace A, Figure 9) both Q3 and Q4 are on. The current source is off and Q2’s collector (trace B) is at ground. C1’s latch input prevents it from responding and its output remains high. When the clock goes low, C1’s latch input is disabled and its output drops low. The Q3 and Q4 collectors lift and Q2 comes on, delivering constant current to the 1000pF capacitor (trace B). The resulting linear ramp is applied to C1 and C2’s positive inputs. C2, biased from a potential derived from the 5V supply, goes high 30 nanoseconds after the ramp begins, providing the “trigger output” (trace C)

Note 3: See Reference 3 for further discussion and recommendations.

Note 4: Additional examples of avalanche pulse generators and theoretical discussion appear in Reference 3 and References 5 through 16. The circuit detailed here produces positive going pulses referred to a zero volt baseline. Level shifting options are presented in Appendix B, “Pulse Generator Output Level Shifting.”

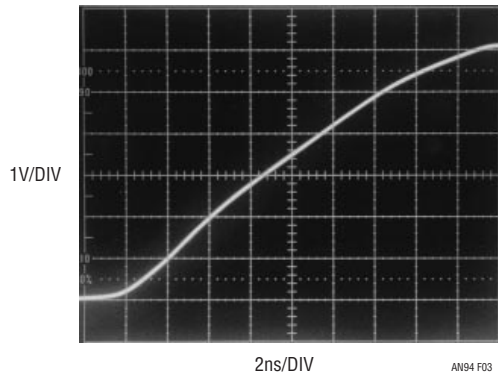

Figure 3. LT1818 Slew Rate Measures $\approx 385\text{V}/\mu\text{s}$ When Driven By Ten Nanosecond Rise Time Pulse Generator

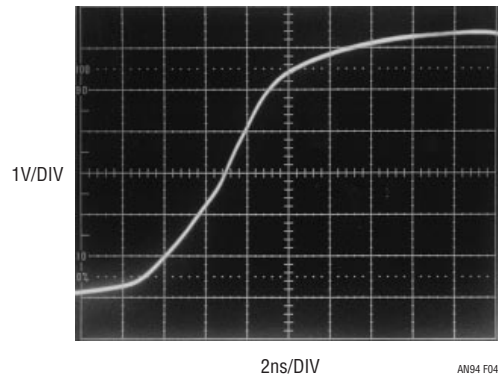

Figure 4. Five Nanosecond Rise Time Pulse Generator Indicates $800\text{V}/\mu\text{s}$ Slew Rate

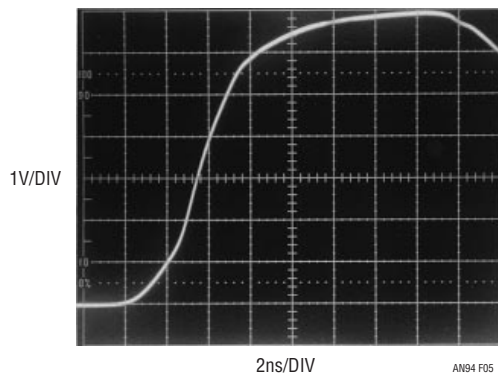

Figure 5. $1400\text{V}/\mu\text{s}$ Slew Rate is Observed with Faster ($t_{\text{RISE}} = 3.5\text{ns}$) Pulse Generator

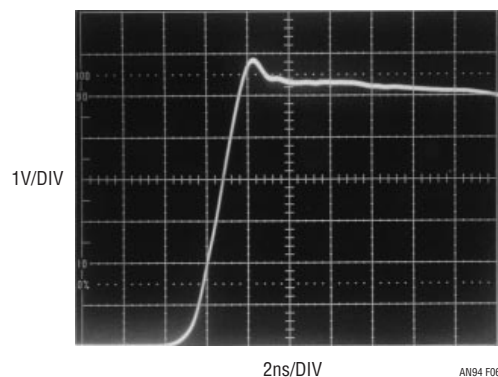

Figure 6. One Nanosecond Rise Time Pulse Generator Results in $2500\text{V}/\mu\text{s}$ Slew Rate. Verifying Slew Rate Limiting Occurrence Requires Repeating Measurement with Subnanosecond Rise Time Pulse Generator

via its output network. C1 goes high when the ramp crosses the potentiometer programmed delay at its negative input, in this case about 170ns. C1 going high triggers the avalanche-based output pulse (trace D), which will be described. This arrangement permits the delay programming control to vary output pulse occurrence from 30 nanoseconds before to 300 nanoseconds after the trigger output. Figure 10 shows the output pulse (trace D) occurring 25ns before the trigger output. All other waveforms are identical to Figure 9.

When C1's output pulse is applied to Q5's base, it avalanches. The result is a quickly rising pulse across Q5's emitter termination resistor. The 10pF collector capacitor and the charge line discharge, Q5's collector voltage falls and breakdown ceases. The 10pF collector capacitor and the charge line then recharge. At C1's next pulse, this action repeats. The 10pF capacitor supplies the initial pulse response, with the charge lines prolonged discharge contributing the pulse body. The 40" charge line length forms an output pulse width about 12ns in duration.

Avalanche operation requires high voltage bias. The LT1533 low noise switching regulator and associated components supply this high voltage. The LT1533 is a "push-pull" output switching regulator with controllable transition times.

Output harmonic content ("noise") is notably reduced with slower switch transition times.⁵ Switch current and voltage transition times are controlled by resistors at the R_{CSL} and R_{VSL} pins, respectively. In all other respects the circuit behaves as a classical push-pull, step-up converter.

Circuit Optimization

Circuit optimization begins by setting the "Output Amplitude Vernier" to maximum and grounding Q4's collector. Next, set the "Avalanche Voltage Adjust" so free running

Note 5: The LT1533's low noise performance and its measurement are discussed in Reference 17.

Application Note 94

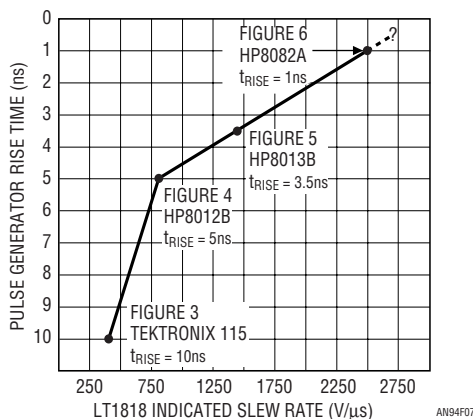

Figure 7. Summarized Data for the Pulse Generators. Decreasing Rise Time Promotes Higher Observed Slew Rate. Verifying Slew Rate Limiting Occurrence Requires Subnanosecond Rise Time Pulse Generator

pulses *just* appear at Q5's emitter, noting the bias test points voltage. Readjust the "Avalanche Voltage Adjust" five volts below this voltage and unground Q4's collector. Set the "30ns Trim" so the trigger output goes low 30ns after the clock goes low. Adjust the delay programming control to maximum and set the "300ns Calib." so C1 goes high 300ns after the clock goes low. Slight interaction between the 30ns and 300ns trims may require repeating their adjustments until both points are calibrated.

Q5 requires selection for optimal avalanche behavior. Such behavior, while characteristic of the device specified, is not guaranteed by the manufacturer. A sample of 30 2N2501s, spread over a 17-year date code span, yielded $\approx 90\%$. All "good" devices switched in less than 475ps with some below 300ps.⁶ In practice, Q5 should be selected for "in-circuit" rise time under 400 picoseconds. Once this is done, output pulse shape is optimized for slew rate testing by adjusting Q5's collector damping trim. The optimization procedure takes full advantage of the freedom that pulse purity is *not* required for slew rate testing. Normally, the pulse edge is carefully adjusted so that maximum transition speed is attained with minimal sacrifice of pulse purity. Slew rate testing does not require this, considerably simplifying optimization.⁷

Slew rate testing permits overshoot and post-transition aberrations if they do not influence amplifier response in the measurement region. Figures 11 through 13 detail the optimization procedure. In Figure 11, the damping trim is set for significant effect, resulting in a reasonably clean pulse but sacrificing rise time.⁸ Figure 12 represents the

opposite extreme. Minimal damping accentuates rise time, but pronounced post-transition ring may influence amplifier operation during slew testing. Figure 13's compromise damping is more realistic. Edge rate is only slightly reduced, but post-transition ring is significantly attenuated. The damping photographs were taken with a 1GHz real time oscilloscope (Tektronix 7104/7A29/7B15) with a 350ps rise time limit. Accurately determining Figure 13's rise time requires more bandwidth.⁹ Figure 14, taken with a 3.9GHz ($t_{RISE} = 90ps$) bandwidth oscilloscope (Tektronix 556 with 1S2 sampling plug-in) indicates 360 picosecond output rise time.¹⁰ Figure 15 aids measurement confidence by verifying 360 picosecond rise time in a 6GHz ($t_{RISE} = 60$ picoseconds) oscilloscope bandwidth (Tektronix TDS 6604). The 360 picosecond rise time is almost three times faster than Figure 6's 1 nanosecond rise time pulse generator, which promoted a 2500V/ μ s slew rate. Figure 16 puts this kind of speed into perspective. Trace A's 360ps rise time has completed its transition before trace B's 400MHz LT1818 amplifier begins to move! Trace A's rise time is actually faster than depicted, as the 1GHz real time measurement bandwidth limits observed response. Applying this faster rise time pulse should add useful information to Figure 7's data.

Refining Slew Rate Measurement

Figure 17 shows amplifier (A = +1) response to the 360 picosecond rise time pulse in a 1GHz real time bandpass. The middle 2/3 of the positive transaction, the slew rate measurement region, appears faster than Figure 6. Figure 18 increases sweep speed to 500 picoseconds/division. The photograph shows a measurement region

Note 6: 2N2501s are available from Semelab plc. Sales@semelab.co.uk; Tel. 44-0-1455-556565
A more common transistor, the 2N2369, may also be used but switching times are rarely less than 450ps. See also Footnotes 10 and 11.

Note 7: Optimization procedures for obtaining high degrees of pulse purity while preserving rise time appear in References 3, 5 and 6.

Note 8: The strata is becoming rarefied when a subnanosecond rise time is described as "sacrificed."

Note 9: Accurate rise time determination at these speeds mandates verifying measurement signal path (cables, attenuators, probes, oscilloscope) integrity. See Appendix A, "Verifying Rise Time Measurement Integrity" and Appendix C, "Connections, Cables, Adapters, Attenuators, Probes and Picoseconds."

Note 10: Experimental adjustment, iterated towards favorable results, of Q5's lead lengths, impedances and layout may be required for fastest rise time.

slew rate of $\approx 2800\text{V}/\mu\text{s}$, revealing an 11% error in Figure 6's determination. Applying these findings to Figure 7's plot produces Figure 19. The new data suggests that, while slew rate "hard" limiting may not be occurring, little practical improvement is possible because rise time is approaching zero. A faster rise time pulse generator could confirm this, but any slew rate improvement would likely

be academic.¹¹ Realistically, the large signal, 360 picosecond rise time input required to promote $2800\text{V}/\mu\text{s}$ slew rate is rarely encountered in practical circuitry.

Note 11: Faster rise times are possible, although considerable finesse is required in Q5's selection, layout, mounting, terminal impedance choice and triggering. The 360ps rise time quoted in the text represents readily reproducible results. Rise times below 300ps have been achieved, but require considerable and tedious effort. See Reference 5 and 6.

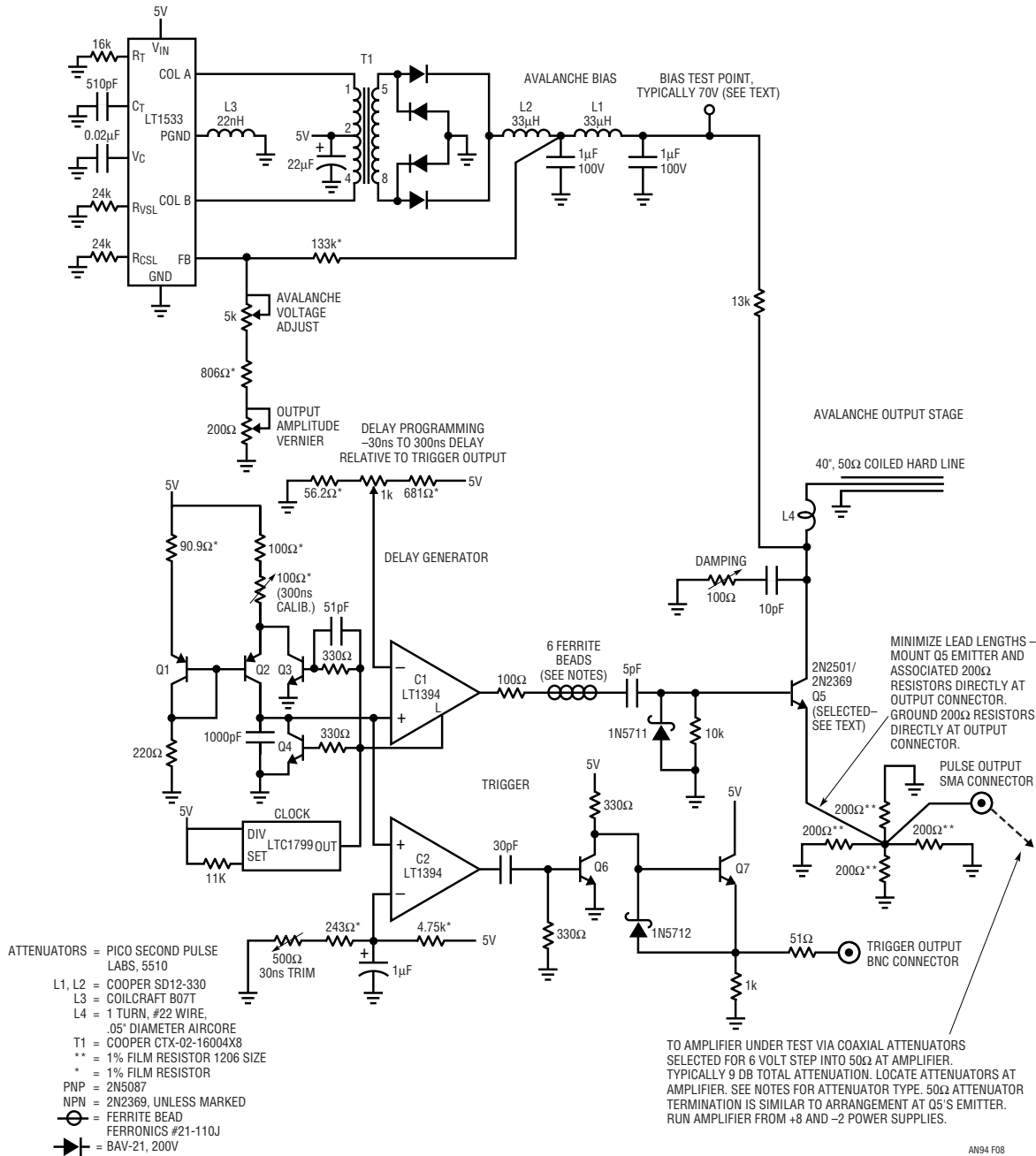

Figure 8. Variable Delay Triggers a Subnanosecond Rise Time Pulse Generator. Charge Line at Q5's Collector Determines ≈ 10 Nanosecond Output Width. Output Pulse Occurance is Settable from Before-to-After Trigger Output

Application Note 94

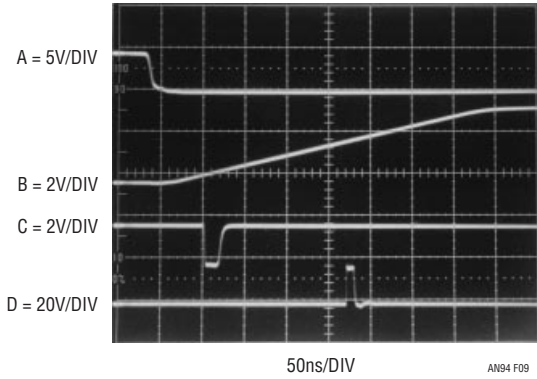

Figure 9. Pulse Generator's Waveforms Include Clock (Trace A), Q2's Collector Ramp (Trace B), Trigger Output (Trace C) and Pulse Output (Trace D). Delay Sets Output Pulse \approx 170ns After Trigger Output

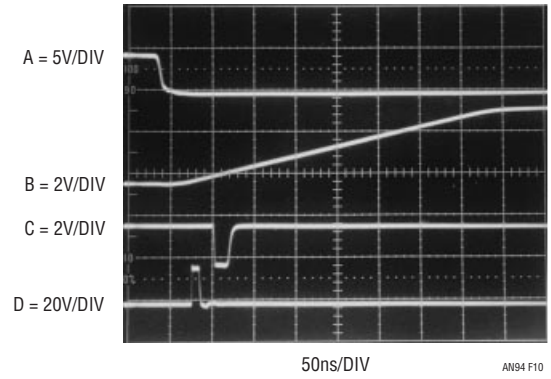

Figure 10. Pulse Generator's Waveforms with Delay Adjusted for Output Pulse Occurrence (Trace D) 25ns Before Trigger Output (Trace C). All Other Activity is Identical to Previous Figure

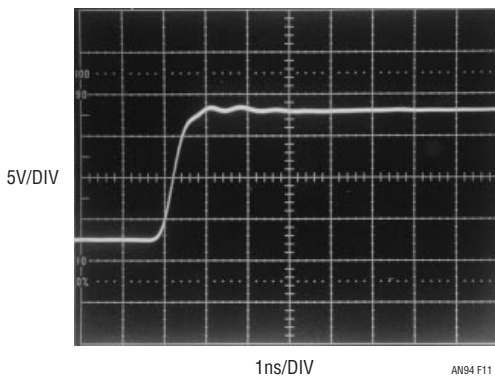

Figure 11. Excessive Damping is Characterized by Front Corner Rounding and Minimal Pulse-Top Aberrations. Trade Off is Relatively Slow Rise Time

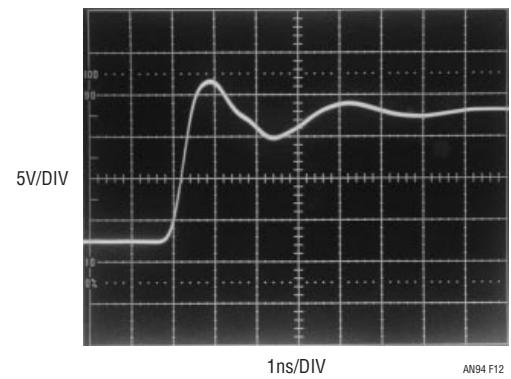

Figure 12. Minimal Damping Accentuates Rise Time, Although Pulse-Top Ringing is Excessive

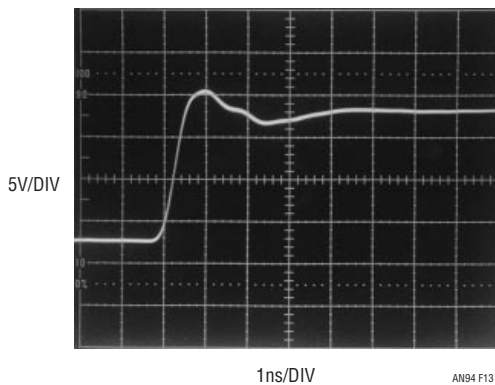

Figure 13. Optimal Damping Retards Pulse-Top Ringing; Preserves Rise Time in Slew Rate Measurement Region

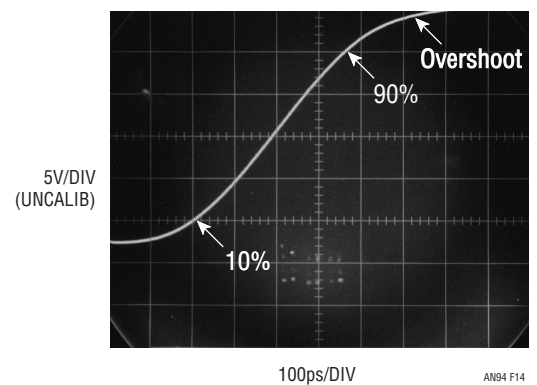

Figure 14. Figure 13's Rise Time Measures 360 Picoseconds in 3.9GHz Sampled Bandpass

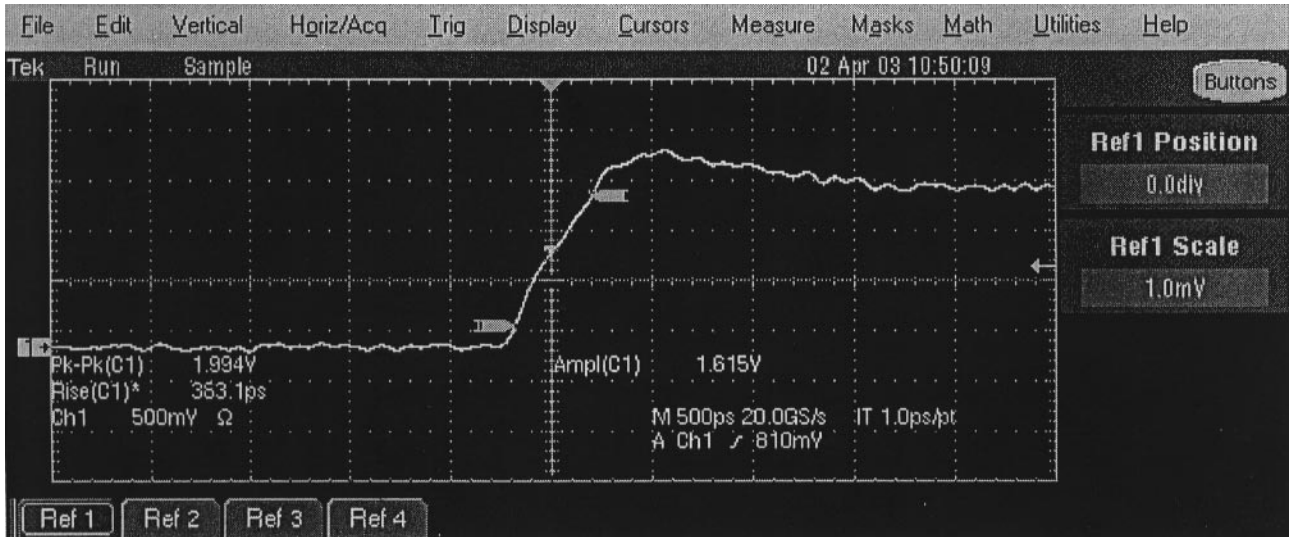

Figure 15. 360 Picosecond Rise Time Monitored in 6GHz Sampled Bandwidth Assures Measurement Integrity

(Courtesy of Michael J. Martin, Tektronix, Inc.)

AN94 F15

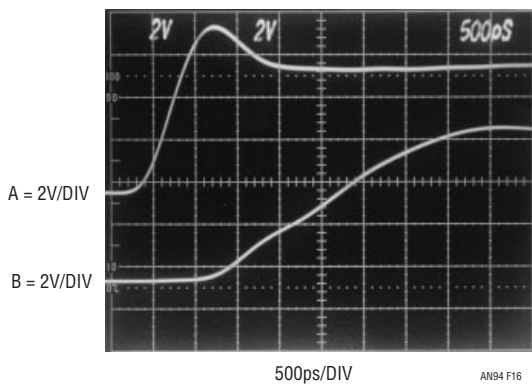

Figure 16. Trace A's 360 Picosecond Rise Time Pulse Completes Transition Before Amplifier Output (Trace B) Begins Movement. Trace A's Rise Time is Actually ≈ 150 ps Faster than Depiction, as 1GHz Measurement Bandwidth Limits Observed Response

AN94 F16

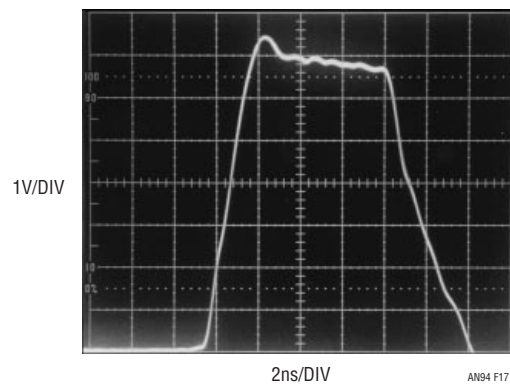

Figure 17. LT1818 Slew Response When Driven from Avalanche Pulse Generator Appears Faster Than Figure 6's 2500V/ μ s

AN94 F17

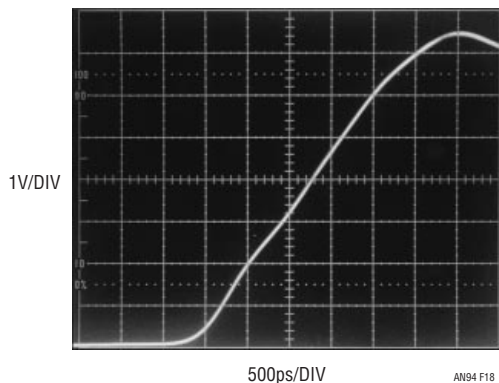

Figure 18. Time Expansion of Figure 17 Shows ≈ 2800 V/ μ s Slew Rate, Revealing 11% Error in Figure 6's 1 Nanosecond Rise Time Driven 2500V/ μ s Response

AN94 F18

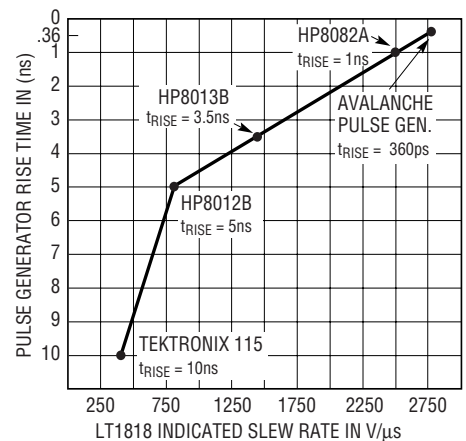

Figure 19. Figure 7's Data Restated to Include Avalanche Pulse Generator Results. Significant Slew Rate Increase is Unlikely Because Required Input Step Rise Time Approaches Zero.

AN94 F19

Application Note 94

REFERENCES

1. Shakespeare, William, "The Taming of the Shrew," 1593–94.
2. Williams, Jim, "Component and Measurement Advances Ensure 16-Bit DAC Settling Time," Linear Technology Corporation, Application Note 74, July 1998.
3. Williams, Jim, "30 Nanosecond Settling Time Measurement for a Precision Wideband Amplifier," Linear Technology Corporation, Application Note 79, September 1999.
4. Williams, Jim, "A Standards Lab Grade 20-Bit DAC with 0.1ppm/°C Drift," Linear Technology Corporation, Application Note 86, January 2001.
5. Braatz, Dennis, "Avalanche Pulse Generators," Private Communication, Tektronix, Inc. 2003.
6. Tektronix, Inc., Type 111 Pretrigger Pulse Generator Operating and Service Manual, Tektronix, Inc. 1960.
7. Haas, Isy, "Millimicrosecond Avalanche Switching Circuit Utilizing Double-Diffused Silicon Transistors," Fairchild Semiconductor, Application Note 8/2, December 1961.
8. Beeson, R. H., Haas, I., Grinich, V. H., "Thermal Response of Transistors in Avalanche Mode," Fairchild Semiconductor, Technical Paper 6, October 1959.
9. G. B. B. Chaplin, "A Method of Designing Transistor Avalanche Circuits with Applications to a Sensitive Transistor Oscilloscope," paper presented at the 1958 IRE-AIEE Solid State Circuits Conference, Philadelphia, PA., February 1958.
10. Motorola, Inc., "Avalanche Mode Switching," Chapter 9, pp 285–304. Motorola Transistor Handbook, 1963.
11. Williams, Jim, "A Seven-Nanosecond Comparator for Single Supply Operation," "Programmable, Subnanosecond Delayed Pulse Generator," pp. 32–34, Linear Technology Corporation, Application Note 72, May 1998.
12. D. J. Hamilton, F. H. Shaver, P. G. Griffith, "Avalanche Transistor Circuits for Generating Rectangular Pulses," *Electronic Engineering*, December, 1962.
13. R. B. Seeds, "Triggering of Avalanche Transistor Pulse Circuits," Technical Report No. 1653-1, August 5, 1960, Solid-State Electronics Laboratory, Stanford Electronics Laboratories, Stanford University, Stanford, California.
14. Williams, Jim, "Measurement and Control Circuit Collection," Linear Technology Corporation, Application Note 45, June 1991.
15. Williams, Jim, "High Speed Amplifier Techniques," Linear Technology Corporation, Application Note 47, August 1991.
16. Williams, Jim, "Practical Circuitry for Measurement and Control Problems," Linear Technology Corporation, Application Note 61, August 1994.
17. Williams, Jim, "A Monolithic Switching Regulator with 100 μ V Output Noise," Linear Technology Corporation, Application Note 70, October 1997.
18. Andrews, James R. "Pulse Measurements in the Picosecond Domain," Picosecond Pulse Labs, Application Note AN-3a, 1988.
19. Martin, Michael J., "Fast Rise Time Oscilloscope Measurement," Private Communication, Tektronix, Inc. 2003.
20. C. J. Madden, M. J. W. Rodwell, R. A. Marsland, D. M. Bloom, and Y. C. Pao, "Generation of 3.5ps fall-time shock waves on a monolithic nonlinear transmission line," *IEEE Electron Device Lett.*, 9, pp. 303–305, 1988.

Note: This Application Note was derived from a manuscript originally prepared for publication in EDN magazine.

APPENDIX A

Verifying Rise Time Measurement Integrity

Any measurement requires the experimenter to insure measurement confidence. Some form of calibration check is always in order. High speed time domain measurement is particularly prone to error, and various techniques can promote measurement integrity.

Figure A1's battery-powered 200MHz crystal oscillator produces 5ns markers, useful for verifying oscilloscope time base accuracy. A single 1.5V AA cell supplies the LTC3400 boost regulator, which produces 5 volts to run the oscillator. Oscillator output is delivered to the 50Ω load via a peaked attenuation network. This provides well defined 5ns markers (Figure A2) and prevents overdriving low level sampling oscilloscope inputs.

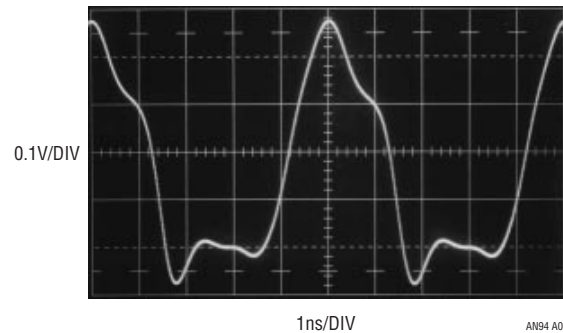

Figure A2. Time Mark Generator Output Terminated into 50Ω. Peaked Waveform is Optimal for Verifying Time Base Calibration

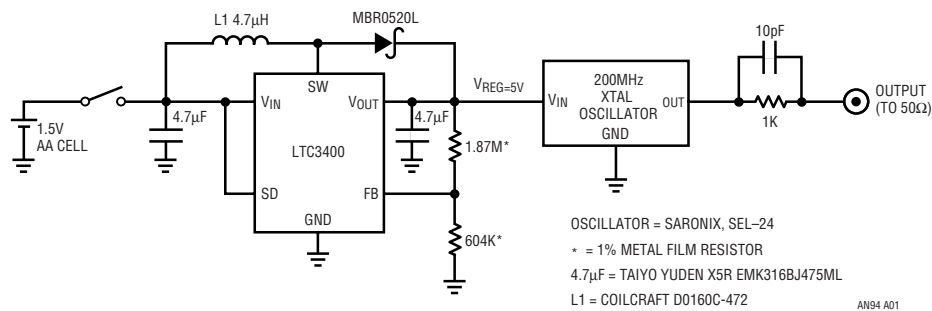

Figure A1. 1.5V Powered, 200MHz Crystal Oscillator Provides 5 Nanosecond Time Markers. Switching Regulator Converts 1.5V to 5V to Power Oscillator

MANUFACTURER	MODEL NUMBER	RISE TIME	AMPLITUDE	AVAILABILITY	COMMENTS
Avtech	AVP2S	40ps	0V to 2V	Current Production	Free Running or Triggered Operation, 0MHz to 1MHz
Hewlett-Packard	213B	100ps	≈175mV	Secondary Market	Free Running or Triggered Operation to 100kHz
Hewlett-Packard	1105A/1108A	60ps	≈200mV	Secondary Market	Free Running or Triggered Operation to 100kHz
Hewlett-Packard	1105A/1106A	20ps	≈200mV	Secondary Market	Free Running or Triggered Operation to 100kHz
Picosecond Pulse Labs	TD1110C/TD1107C	20ps	≈230mV	Current Production	Similar to Discontinued HP1105/1106/8A. See above.
Stanford Research Systems	DG535 OPT 04A	100ps	0.5V to 2V	Current Production	Must be Driven with Stand-alone Pulse Generator
Tektronix	284	70ps	≈200mV	Secondary Market	50kHz Repetition Rate. Pre-trigger 75ns to 150ns Before Main Output. Calibrated 100MHz and 1GHz Sine Wave Auxiliary Outputs
Tektronix	111	500ps	≈±10V	Secondary Market	10kHz to 100kHz Repetition Rate. Positive or Negative Outputs. 30ns to 250ns Pre-trigger Output. External Trigger Input. Pulse Width Set with Charge Lines
Tektronix	067-0513-00	30ps	≈400mV	Secondary Market	60ns Pre-trigger Output. 100kHz Repetition Rate
Tektronix	109	250ps	0V to ±55V	Secondary Market	≈600Hz Repetition Rate (High Pressure Hg Reed Relay Based). Positive or Negative Outputs. Pulse Width Set by Charge Lines

Figure A3. Picosecond Edge Generators Suitable for Rise Time Verification. Considerations Include Speed, Features and Availability

Application Note 94

Once time base accuracy is confirmed it is necessary to check rise time. The lumped signal path rise time, including attenuators, connections, cables, oscilloscope and anything else, should be included in this measurement. Such “end-to-end” rise time checking is an effective way to promote meaningful results. A guideline for insuring accuracy is to have 4x faster measurement path rise time than the rise time of interest. Thus, text Figure 14’s 360 picosecond rise time measurement requires a verified 90 picosecond measurement path rise time to support it. Verifying the 90 picosecond measurement path rise time, in turn, necessitates a ≤ 22.5 picosecond rise time test step. Figure A3 lists some very fast edge generators for rise time checking.¹

The Hewlett-Packard 1105A/1106A, specified at 20 picoseconds rise time, was used to verify text Figure 14’s measurement signal path. Figure A4 indicates a 90 picosecond rise time, promoting measurement confidence.

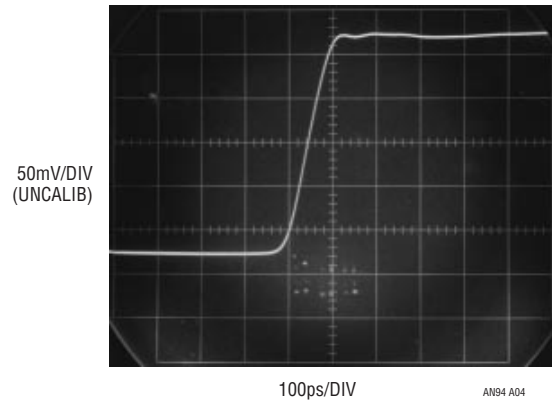

Figure A4. 20 Picosecond Step Produces ≈ 90 Picosecond Oscilloscope Rise Time, Verifying Text Figure 14’s Measurement Path Fidelity

Note 1: This is a fairly exotic group, but equipment of this caliber really is necessary for rise time verification.

APPENDIX B

Pulse Generator Output Level Shifting

The text’s avalanche pulse generator produces a positive 15V to 20V output. This is not suitable for most amplifiers. Various amplifier configurations require different forms of level shifting. A difficulty is that whatever level shift mechanism is employed must not degrade pulse rise time.

The simplest level shift is pure attenuation, facilitated by the coaxial attenuators listed in text Figure 8’s notes. These devices, well specified in the time domain, have 8 picosecond rise time. Combining these attenuators with amplifier power supplies of 8V and -2 V permitted a 6V pulse to bias the unity gain follower used in the text’s test.

In some cases the pulse must be negatively biased or inverted. Figure B1 shows ways to do this. The “bias tee” network capacitively strips the input’s DC component, re-establishing it with the potential present at the DC bias input. The inverting network, an autotransformer, magnetically accomplishes pulse inversion at unity gain. These conceptually straightforward networks are deceptively simple in appearance. Maintaining pulse fidelity and rise time at picosecond speeds involves numerous construction subtleties. The commercially available units noted in the figure are recommended.

Figure B2 shows bias tee response (trace B) to a fast input step (trace A). The output, in this case biased from -3 V, faithfully reproduces the input with only 300 picoseconds skew, primarily due to uncompensated measurement fixture delays.

Figure B3 records inverting transformer response (trace B) to trace A’s input. Rise time and fidelity are uncompromised, with about 600 picoseconds propagation delay.

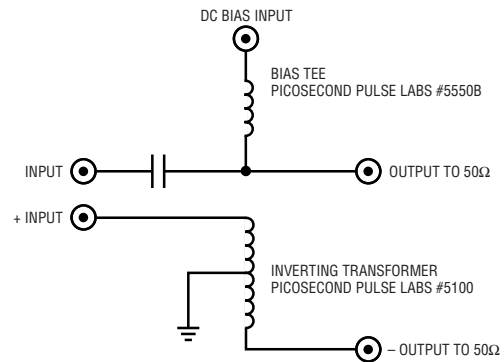

Figure B1. Output Level Shifters Include Bias Tee for DC Offsetting and Inverting Transformer for Negative Outputs. Practical Realization of Conceptually Simple Networks Requires Care to Maintain Picosecond Speed Fidelity

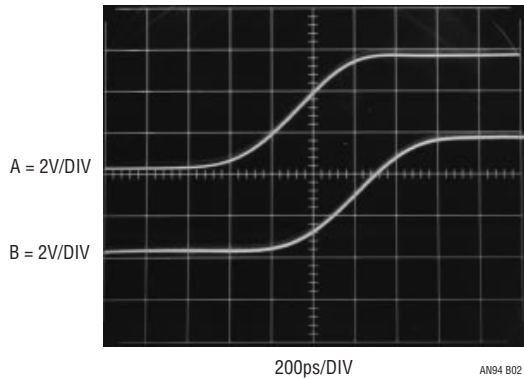

Figure B2. Bias Tee's Level Shifted Output (Trace B) Faithfully Reproduces Input (Trace A) in 3.9GHz Sampled Bandpass. 300 Picosecond Timing Skew Derives from Bias Tee and Measurement Fixture Delays

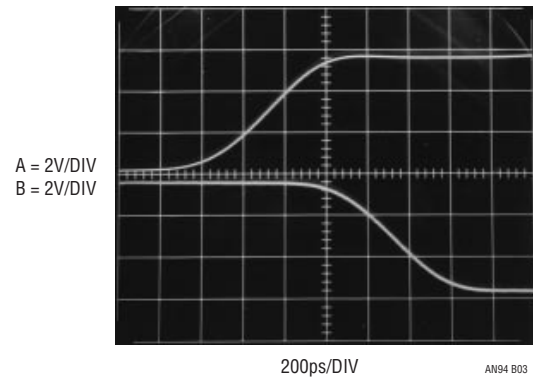

Figure B3. Wideband Pulse Transformers Output (Trace B) Inverts Input (Trace A) with Uncompromised Fidelity and 600 Picosecond Delay

APPENDIX C

Connections, Cables, Adapters, Attenuators, Probes and Picoseconds

Subnanosecond rise time signal paths must be considered as transmission lines. Connections, cables, adapters, attenuators and probes represent discontinuities in this transmission line, deleteriously effecting its ability to faithfully transmit desired signal. The degree of signal corruption contributed by a given element varies with its deviation from the transmission lines nominal impedance. The practical result of such introduced aberrations is degradation of pulse rise time, fidelity, or both. Accordingly, introduction of elements or connections to the signal path should be minimized and necessary connections and elements must be high grade components. Any form of connector, cable, attenuator or probe must be fully specified for high frequency use. Familiar BNC hardware becomes lossy at rise times much faster than 350ps. SMA components are preferred for the rise times described in the text. Additionally, the avalanche pulse generator output cable should be 50Ω “hard line” or, at least, teflon-based coaxial cable fully specified for high frequency operation. Optimal connection practice eliminates any cable by coupling the generator output (via the necessary coaxial attenuators—see Figure 8) *directly* to the amplifier under test input. For example, replacing 18” of output cable with a direct connection improved generator rise time from 380 picoseconds to 360 picoseconds.

Mixing signal path hardware types via adapters (e.g. BNC/SMA) should be avoided. Adapters introduce significant parasitics, resulting in reflections, rise time degradation, resonances and other degrading behavior. Similarly, oscilloscope connections should be made directly to the instrument’s 50Ω inputs, avoiding probes. If probes must be used, their introduction to the signal path mandates attention to their connection mechanism and high frequency compensation. Passive “Z₀” types, commercially available in 500Ω (10x) and 5kΩ(100x) impedances, have input capacitance below 1pf. Any such probe must be carefully frequency compensated before use or misrepresented measurement will result. Inserting the probe into the signal path necessitates some form of signal pick-off which nominally does not influence signal transmission. In practice, some amount of disturbance must be tolerated and its effect on measurement results evaluated. High quality signal pick-offs always specify insertion loss, corruption factors and probe output scale factor.

The preceding emphasizes vigilance in designing and maintaining a signal path. Skepticism, tempered by enlightenment, is a useful tool when constructing a signal path and no amount of hope is as effective as preparation and directed experimentation.

